



Instruction Manual

Pneumatic Direct-acting Pressure Reducing Valve
for Steam and Air

PN-DR

Contents

Contents	1
Introduction	1
Safety Considerations	2
Specifications	4
Acceptable Operating Range	4
Configuration	5
Correct Usage of the PN-DR Direct-acting Pressure Reducing Valve	6
Installation	8
Adjustment	11
Maintenance	12
Disassembly	13
Reassembly	16
Troubleshooting	17
TLV EXPRESS LIMITED WARRANTY	20
Service	22

Introduction

Thank you for purchasing the TLV PN-DR pneumatic direct-acting pressure reducing valve for steam and air.

This product has been thoroughly inspected before being shipped from the factory. When the product is delivered, before doing anything else, check the specifications and external appearance to make sure nothing is out of the ordinary. Also be sure to read this manual carefully before use and follow the instructions to be sure of using the product properly.

The TLV PN-DR pneumatic direct-acting pressure reducing valve provides a more stable secondary pressure than conventional direct-acting reducing valves. The PN-DR is designed for a long service life, and is made of stainless steel for superior durability.





For products with special order specifications or options, if detailed instructions for the special order specifications or options are not contained in this manual, please contact TLV for full details.

This instruction manual is intended for use with the model(s) listed on the front cover. It is necessary not only for installation but for subsequent maintenance, disassembly/reassembly and troubleshooting. Please keep it in a safe place for future reference.

Safety Considerations

- Read this section carefully before use and be sure to follow the instructions.
- Installation, inspection, maintenance, repairs, disassembly, adjustment and valve opening/closing should be carried out only by trained maintenance personnel.
- The precautions listed in this manual are designed to ensure safety and prevent equipment damage and personal injury. For situations that may occur as a result of erroneous handling, three different types of cautionary items are used to indicate the degree of urgency and the scale of potential damage and danger: DANGER, WARNING and CAUTION.
- The three types of cautionary items above are very important for safety: be sure to observe all of them as they relate to installation, use, maintenance, and repair. Furthermore, TLV accepts no responsibility for any accidents or damage occurring as a result of failure to observe these precautions.

Symbols

	Indicates a DANGER, WARNING or CAUTION item.
	Indicates an urgent situation which poses a threat of death or serious injury
	Indicates that there is a potential threat of death or serious injury
	Indicates that there is a possibility of injury or equipment / product damage

	<p>Install properly and DO NOT use this product outside the recommended operating pressure, temperature and other specification ranges. Improper use may result in such hazards as damage to the product or malfunctions that may lead to serious accidents. Local regulations may restrict the use of this product to below the conditions quoted.</p> <p>Take measures to prevent people from coming into direct contact with product outlets. Failure to do so may result in burns or other injury from the discharge of fluids.</p> <p>When disassembling or removing the product, wait until the internal pressure equals atmospheric pressure and the surface of the product has cooled to room temperature. Disassembling or removing the product when it is hot or under pressure may lead to discharge of fluids, causing burns, other injuries or damage.</p> <p>Be sure to use only the recommended components when repairing the product, and NEVER attempt to modify the product in any way. Failure to observe these precautions may result in damage to the product and burns or other injury due to malfunction or the discharge of fluids.</p>
---	---

Continued on the next page

 CAUTION	Do not use excessive force when connecting threaded pipes to the product.
	Over-tightening may cause breakage leading to fluid discharge, which may cause burns or other injury.
	Use only under conditions in which no freeze-up will occur.
	Freezing may damage the product, leading to fluid discharge, which may cause burns or other injury.
	Use only under conditions in which no water hammer will occur.
	The impact of water hammer may damage the product, leading to fluid discharge, which may cause burns or other injury.

Specifications



Install properly and **DO NOT** use this product outside the recommended operating pressure, temperature and other specification ranges. Improper use may result in such hazards as damage to the product or malfunctions which may lead to serious accidents. Local regulations may restrict the use of this product to below the conditions quoted.



Use only under conditions in which no freeze-up will occur. Freezing may damage the product, leading to fluid discharge, which may cause burns or other injury.

Refer to the product nameplate for detailed specifications.

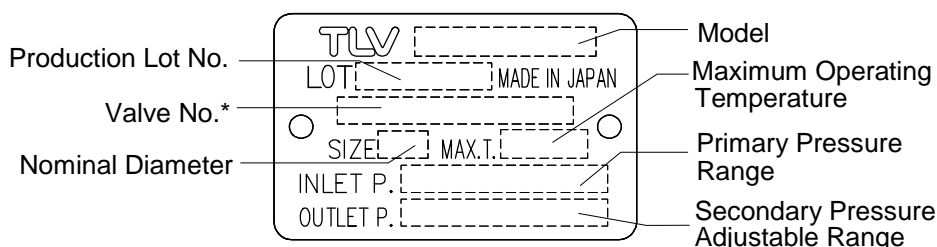

* Valve No. is displayed for products with options. This item is omitted from the nameplate when there are no options.

Acceptable Operating Range

Model	PN-DR-2	PN-DR-6
Primary Pressure Range	0.2 to 1.6 MPaG (30 to 230 psig)	
Adjustable Pressure Range	0.014 to 0.2 MPaG (2 to 30 psig) (but limited to 1/30 of primary pressure)	0.18 to 0.6 MPaG (27 to 85 psig)
	Secondary pressure must not exceed 90% of primary pressure	
Maximum Operating Temperature	220 °C (428 °F)	
Minimum Adjustable Flow Rate	Steam: 20 kg/h (44 lb/h) Air: 5% or more of the rated flow rate	
Motive Air Pressure	0 to 1.0 MPaG (0 to 150 psig) (Oil free air, filtered to 5 µm)	

(1MPa = 10.197 kg/cm²)

Configuration

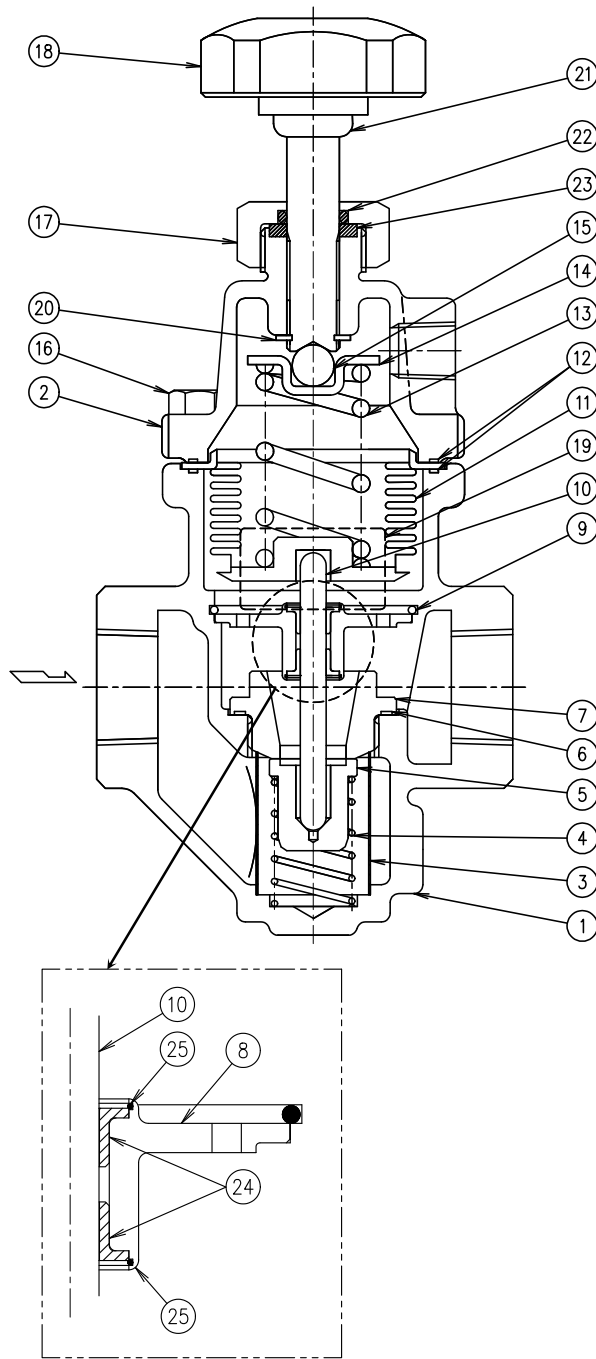

No.	Name	A* ¹	B* ¹	C* ¹	D* ¹	E* ¹
1	Body					
2	Cover					
3	Screen			✓		
4	Coil Spring			✓		
5	Main Valve			✓		
6	Valve Seat Gasket	✓		✓		
7	Valve Seat			✓		
8	Spacer* ³		✓			
9	Snap Ring					
10	Valve Stem		✓			
11	Bellows				✓	
12	Cover Gasket* ²	✓	✓	✓	✓	✓
13	Coil Spring					
14	Spring Guide					
15	Steel Ball					
16	Cover Bolt					
17	Holder Nut					
18	Adjustment Handle					✓
19	Nameplate					
20	Retaining Ring					✓
21	Retainer					✓
22	Seal Ring	✓				✓
23	Packing	✓				✓
24	Slide Bearing* ² * ³		✓			
25	Snap Ring* ² * ³		✓			

*¹Replacement parts are available only in the following kits:

- A: Maintenance Kit
- B: Repair Kit for Spacer
- C: Repair Kit for Main Valve,
- D: Repair Kit for Bellows
- E: Repair Kit for Adjustment Handle

*²Number of parts: 2 pieces

*³Shipped as a unit

Correct Usage of the PN-DR Direct-acting Pressure Reducing Valve



Install properly and **DO NOT** use this product outside the recommended operating pressure, temperature and other specification ranges. Improper use may result in such hazards as damage to the product or malfunctions which may lead to serious accidents. Local regulations may restrict the use of this product to below the conditions quoted.

1. The PN-DR should be operated only within its specifications.
2. Installing an ON/OFF Valve (Solenoid Valve or Motorized Valve)

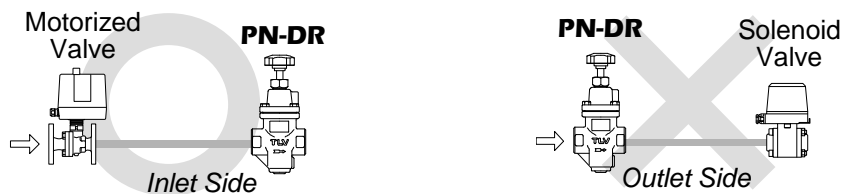

If an on-off valve is required to stop supply of steam or air to the equipment, install it at the inlet side of the PN-DR.

If a solenoid valve is installed at the outlet of the PN-DR, it will cause heavy chattering and may lead to damage of the PN-DR. (When the on-off valve opens, the secondary pressure of the reducing valve changes from zero to the set pressure. Passing through an area of the reducing ratio of less than 30:1 where adjustment is impossible, chattering occurs momentarily.) To save energy, install the on-off valve as near to the boiler, or compressor, as possible.

NOTE: To prevent water hammer, it is recommended that a slow-acting motorized on-off valve be used. If a fast-acting solenoid valve is used, the potential water hammer effect can damage the equipment and the pressure reducing valve.

3. Installing a Control and/or Safety Valve

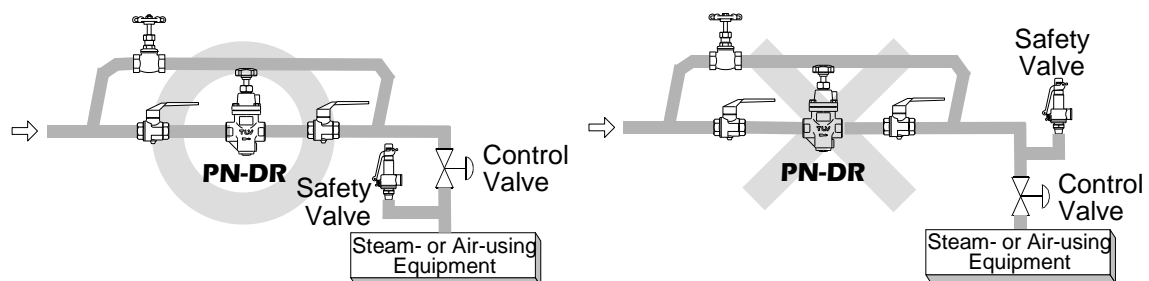

A control valve (i.e. for temperature control) installed between the PN-DR and the equipment (downstream of the PN-DR) may raise the pressure between the PN-DR and the control valve when the control valve is closed, depending on their proximity. Therefore, this valve should be installed close to the steam- or air-using equipment, as illustrated. Also, a safety valve should be installed downstream of the control valve.

NOTE: When installing a safety valve to protect the steam- or air-using equipment, be sure to install it on the steam- or air-using equipment, or directly before the inlet of the equipment. If the safety valve is installed between the PN-DR and a control valve, an eventual pressure rise could activate the safety valve.

4. Recommended Straight Pipe Runs

In order to ensure a stable flow of air or steam, the piping upstream and downstream of the PN-DR must be straight runs. If the PN-DR is installed either directly before or after an elbow or control valve, unevenness in flow may result in chattering and unstable pressure.

To ensure a stable flow, it is recommended that the PN-DR be installed on straight runs of piping, as illustrated below.

① Inlet (primary side) of the PN-DR

NOTE: d = pipe diameter

Maintain a straight piping run of **10 d or more** when a manual valve, a strainer or an elbow, etc. is installed.
(Example: if nominal size is 25 mm (1 in), have 250 mm (10 in) or more)

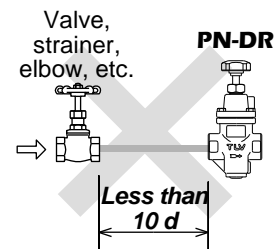
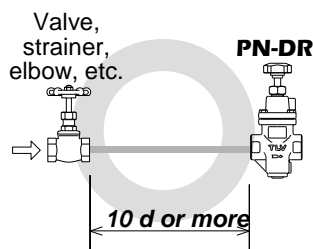

Maintain a straight piping run of **30 d or more** when an automated valve (on-off valve) is installed.
(Example: if nominal size is 25 mm (1 in), have 750 mm (30 in) or more)

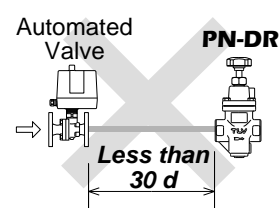
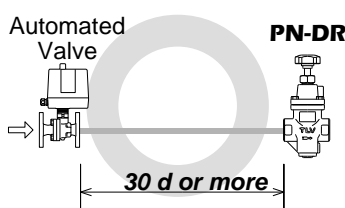

Maintain a straight piping run of **30 d or more** when another pressure reducing valve is installed. (Two-stage pressure reduction)
(Example: if nominal size is 25 mm (1 in), have 750 mm (30 in) or more)

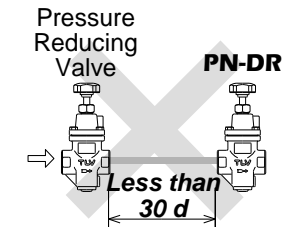
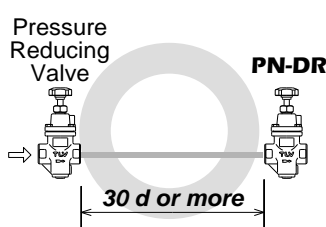

② Outlet (secondary side) of the PN-DR

Maintain a straight piping run of **15 d or more** when a manual valve, a strainer or an elbow, etc. is installed.
(Example: if nominal size is 25 mm (1 in), have 375 mm (15 in) or more)

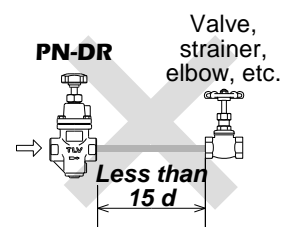
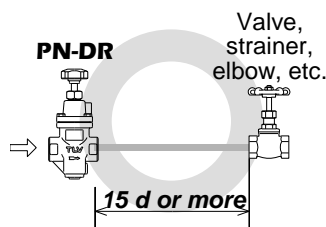

Maintain a straight piping run of **30 d or more** when a safety valve is installed.
(Example: if nominal size is 25 mm (1 in), have 750 mm (30 in) or more)

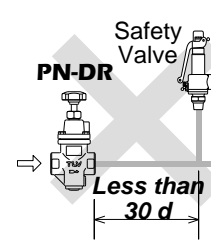
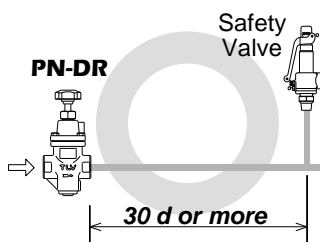

Installation



Install properly and **DO NOT** use this product outside the recommended operating pressure, temperature and other specification ranges. Improper use may result in such hazards as damage to the product or malfunctions which may lead to serious accidents. Local regulations may restrict the use of this product to below the conditions quoted.



Take measures to prevent people from coming into direct contact with product outlets. Failure to do so may result in burns or other injury from the discharge of fluids.

Installation, inspection, maintenance, repairs, disassembly, adjustment and valve opening/closing should be carried out only by trained maintenance personnel.

1. Blowdown

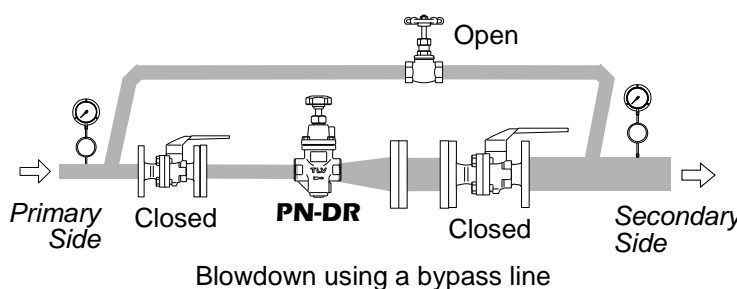

Before installing the PN-DR unit, be sure to blow down all piping thoroughly. If this is not possible, perform a blowdown using the bypass valve. Blowdown is especially important for newly installed piping or after the system has been shut down for a long period of time.

2. Removing the Protective Caps

Before installation, be sure to remove all protective seals and caps covering the product inlet/outlet and the connecting port. (Found in 3 locations; on the product inlet and outlet, motive air connecting port.)

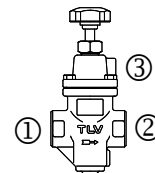

3. Installation Angle

Make sure the PN-DR is installed on horizontal piping with the adjustment handle facing up. Ensure the raised TLV lettering on the body is horizontal and the arrow is pointing in the direction of flow. The allowable inclination of the PN-DR is 10° front-to-back and 15° horizontally.

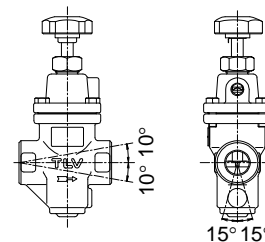

4. Piping Support

Install the PN-DR paying attention to avoid excessive load, bending and vibration. Support the inlet and outlet pipes securely.

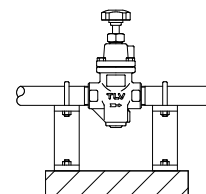

5. Maintenance Space

Leave sufficient space for maintenance, inspection and repair.

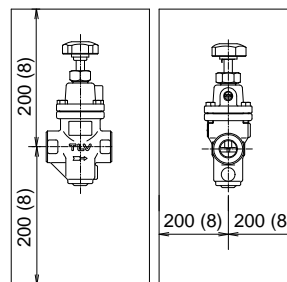

Unit: mm (in)

6. Piping Size/Diffuser

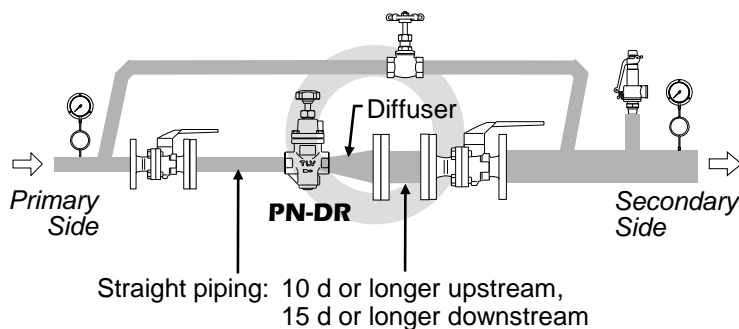

If it is expected that the secondary flow velocity will be more than 30m/s (100 ft/s), install a diffuser in order to keep the flow velocity below 30m/s(100 ft/s). If the distance between the PN-DR and the steam- and air-using equipment is great, a possible drop in pressure should be taken into consideration when selecting the piping size. If installing a strainer, horizontal installation is recommended in order to prevent pooling of condensate.

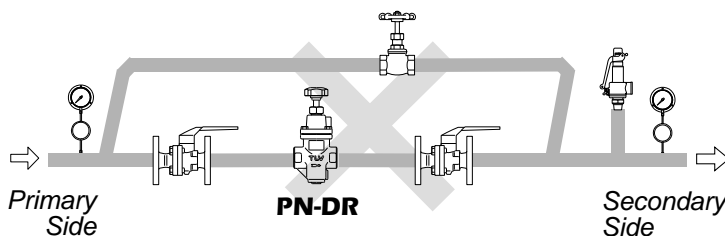

7. Two-stage Pressure Reduction

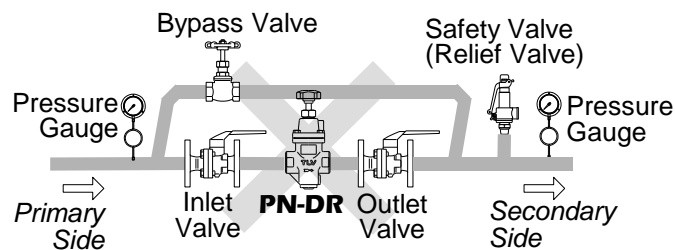
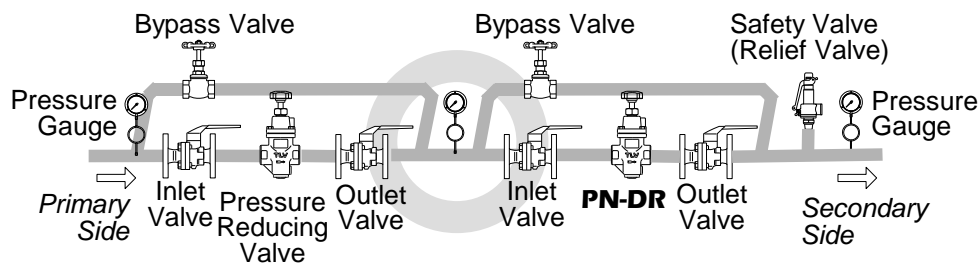

Employ 2-stage pressure reduction if the required reduction is not possible due to PN-DR operating range limitations (when it is not possible to reduce to the desired pressure using a single PN-DR).

8. Accessories

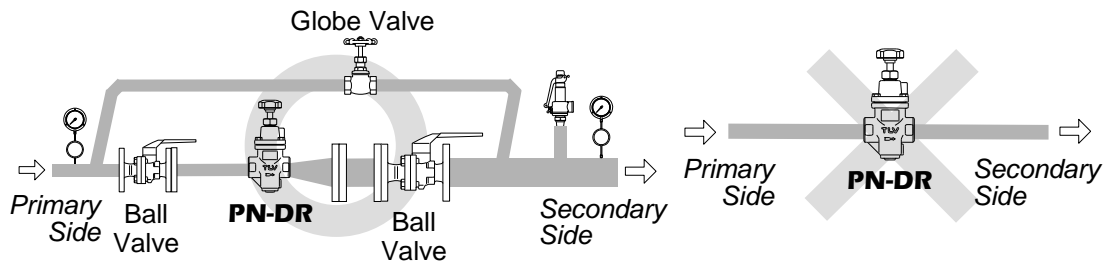

Always install a bypass line. At the inlet and outlet, install a pressure gauge and a shut-off valve. Ball valves, which will not retain condensate, are recommended for inlet/outlet shut-off valves. The nominal pipe size for the bypass line should be $\frac{1}{2}$ or greater of the primary pipe size.

9. Motive Air

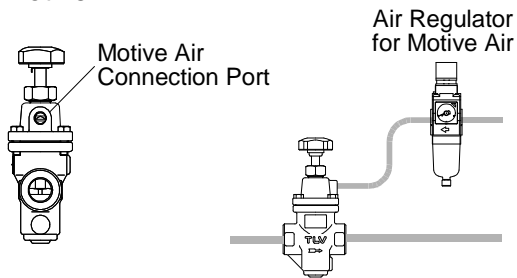

Supply oil free air filtered to $5\ \mu\text{m}$ for the motive air and adjust the air pressure to match desired value by using an air regulator or similar device.

Adjustment

The PN-DR can set secondary pressure(s) either by operation of the adjustment handle or adjustment of the motive air pressure, or a combination of both.

To avoid problems such as water hammer and to protect steam- and air-using equipment, the PN-DR should be correctly adjusted.

1. It is necessary to blow down all pipelines thoroughly. The blowdown is especially important if the line is new or has been shut down for a long period of time. Take particular care to ensure that matter such as condensate and dirt does not remain inside the steam- and air-using equipment. (Stay clear of any pressurized blow-out from the safety valve.)

2. Make sure that the shut-off and bypass valves located upstream and downstream of the PN-DR are completely closed.
3. Turn the adjustment handle counter-clockwise to free the coil spring.

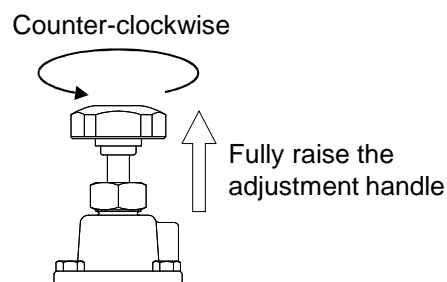

4. Slowly, fully open the shut-off valve at the inlet of the PN-DR.
5. Slightly open the shut-off valve at the outlet of the PN-DR.
6. Slowly turn the adjustment handle clockwise until the desired secondary (steam or air) pressure is obtained with the pressure of the coil spring. Wait several minutes. Be careful not to make rapid adjustments as the safety valve may be activated or equipment may be damaged by water hammer.

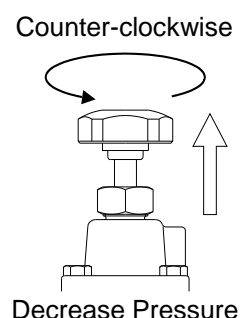
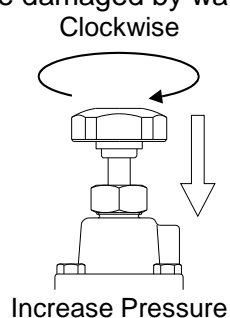

7. Slowly, fully open the shut-off valve at the outlet of the PN-DR.
8. When shutting down the system, always close the outlet shut-off valve first and then the inlet valve.

Maintenance



Take measures to prevent people from coming into direct contact with product outlets. Failure to do so may result in burns or other injury from the discharge of fluids.



Be sure to use only the recommended components when repairing the product, and NEVER attempt to modify the product in any way. Failure to observe these precautions may result in damage to the product or burns or other injury due to malfunction or the discharge of fluids.

Operational Check

To ensure a long service life for the PN-DR, the following inspection and maintenance should be performed regularly.

Part	Inspection and Maintenance Frequency
Screen	Disassemble and clean annually. If there is substantial blockage, install a strainer (approximately 60 mesh) ahead of the PN-DR.
Main Valve, Valve Seat	If there is chattering or dirt, premature wear may result.
Valve Stem, Spacer (Slide Bearing)	If hunting or chattering takes place, premature wear may result.
Bellows	If hunting or chattering takes place, cracks or fatigue may develop in a short period of time.
Seal Ring	Replace annually. Premature wear may occur.
Packing	Replace annually. Premature wear may occur.

Disassembly



When disassembling or removing the product, wait until the internal pressure equals atmospheric pressure and the surface of the product has cooled to room temperature. Disassembling or removing the product when it is hot or under pressure may lead to discharge of fluids, causing burns, other injuries or damage.

It is a recommended practice to dismantle and inspect the PN-DR once a year for preventive maintenance purposes. It is especially important to perform an inspection immediately after the initial run of a new line or before or after equipment such as a heater is taken out of service for a long period of time. (Installation, inspection, maintenance, repairs, disassembly, adjustment and valve opening/closing should be carried out only by trained maintenance personnel.)

Remove all steam/pressurized air from the piping (both upstream and downstream). Remove all motive air pressure.

Wait for the body to cool before attempting to remove the PN-DR from the line. Then remove the PN-DR from the piping, and secure it in a vise to perform the inspection.

Disassembling the Adjusting Section

Loosen the adjustment handle completely and remove the cover bolts. After removing the cover, you will see the steel ball, the spring retainer and the coil spring.
⇒ Check for seizure or any damaged screw threads.

Remove the retaining ring. The seal ring and the packing can be removed by loosening the adjustment handle and the holder nut.

⇒ Check and make sure that the seal ring has not deteriorated and the packing has no abnormalities.

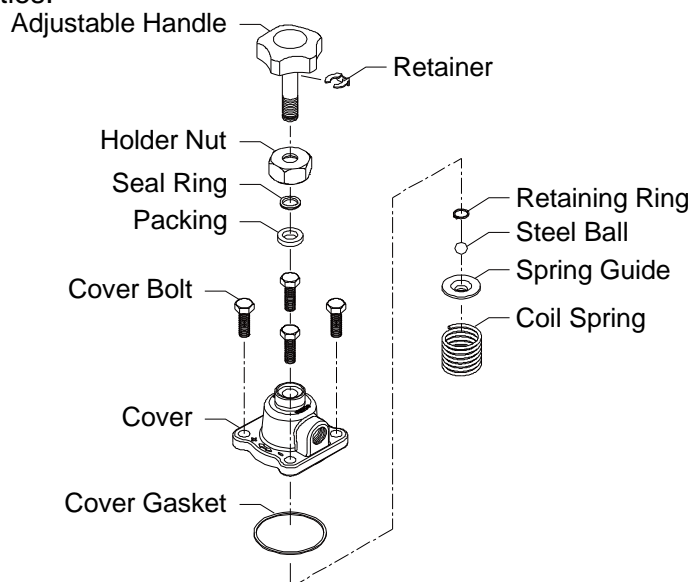

Disassembling the Bellows Section

Remove the bellows from the body, then the valve stem. Pinch the straight sections of the snap ring that is holding the spacer together using a tool such as needle-nose pliers and remove the snap ring. Remove the spacer.

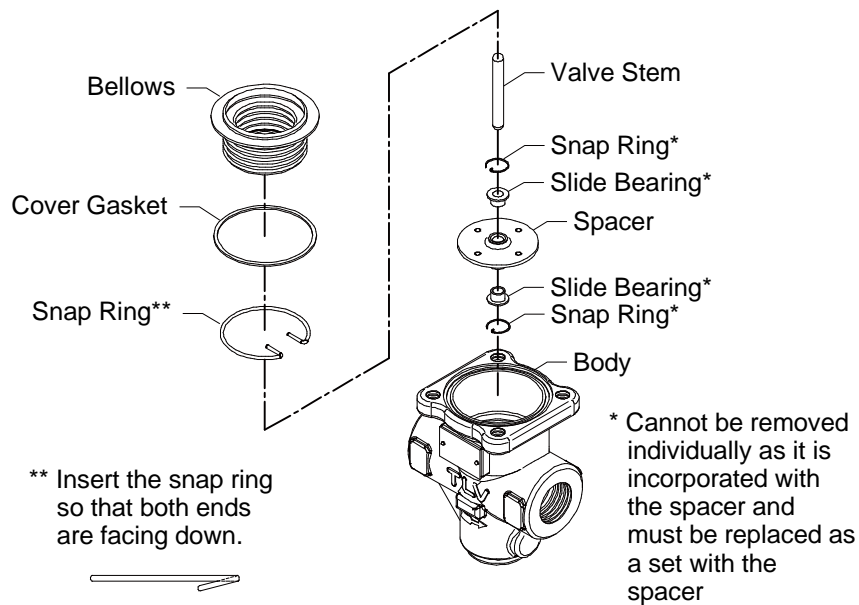

Disassembling the Valve Section

Loosen the valve seat with a wrench and remove it from the body. The coil spring is exerting an upward pressure on the bottom of the valve seat, so be careful that the valve seat is not thrown out. After removing the valve seat, remove the main valve, the coil spring and the screen.

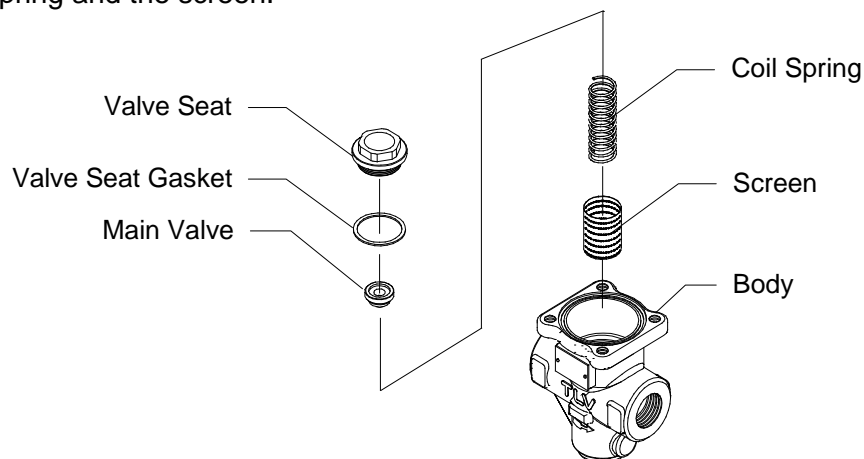

Cleaning

After inspection and removal of any abnormalities, clean and reassemble the parts. The following parts will require cleaning before reassembly:

Threads of the adjustment handle, threads of the cover, bellows, holder nut, valve stem, main valve, valve seat, spacer (including slide bearing), screen

It is permissible to clean using water. However, cleaning with a mild detergent is recommended for more effective cleaning.

Exploded View

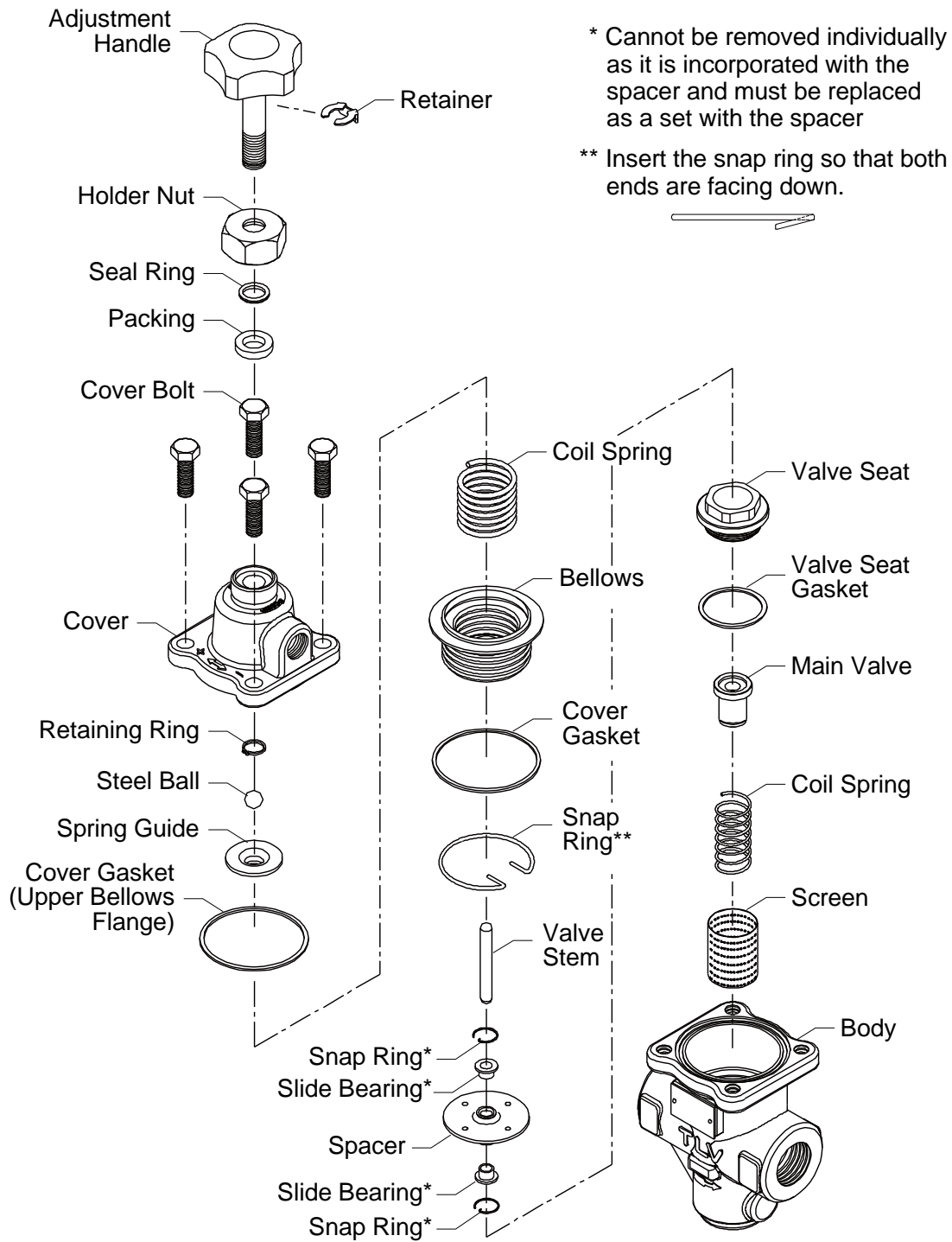

Reassembly

Reassemble the unit using the same procedure as used for disassembling it; but in reverse order. In addition, observe the following precautions:

1. The PTFE gasket may be re-used if free from fault, crushing or deformation.
2. Apply anti-seize to the steel ball and threaded portions of screws, bolts and the adjustment handle. Apply a small amount of anti-seize agent to the threads of the valve seat carefully to ensure it does not come into contact with other parts.
3. Fasten the bolts one at a time in a diagonal pattern alternately to provide uniform seating.
4. After assembly, make sure that the valve stem operates smoothly without binding.

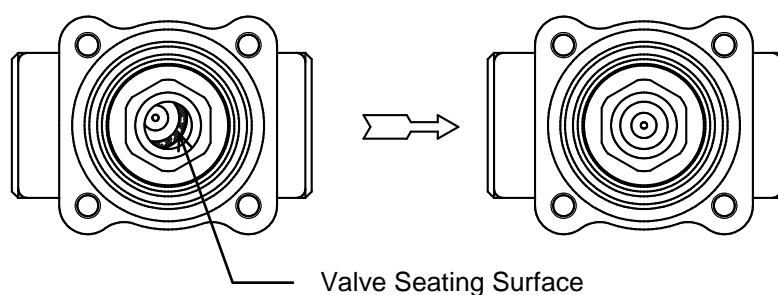

As shown in the figures above, when the valve is tightened it may become off-centered on the valve seat. If this occurs, move the valve back to center.

5. Standard torque for fastening the respective screws and the width across flats of the tools to be used are as follows:

Part	Torque		Distance Across Flats	
	N·m	(lb·ft)	mm	(in)
Cover Bolt	25	(19)	13	($\frac{1}{2}$)
Valve Seat	120	(88)	27	($1\frac{1}{16}$)
Holder Nut	10	(7)	30	($1\frac{3}{16}$)

(1 N·m \approx 10 kg·cm)

NOTE: - If drawings or other special documentation were supplied for the product, any torque given there takes precedence over values shown here.

Troubleshooting



When disassembling or removing the product, wait until the internal pressure equals atmospheric pressure and the surface of the product has cooled to room temperature. Disassembling or removing the product when it is hot or under pressure may lead to discharge of fluids, causing burns, other injuries or damage.

This product is shipped after stringent checks and inspection, and should perform its intended function for a long period of time without failure. However, should there be any problem encountered in the operation of the PN-DR, consult the troubleshooting guide below. Problems are classified as follows:

1. The secondary pressure does not increase
2. The secondary pressure cannot be adjusted or increases abnormally
3. Hunting (fluctuation of the secondary pressure) occurs
4. Chattering (a heavy mechanical noise) occurs
5. Abnormal noises

Major causes for the above problems are usage under non-specified conditions (out of specification), insufficient pressure or flow rate, and clogs by dirt and scale.

To ensure performance for a long period of time, it is recommended that the "Acceptable Operating Range", "Correct Usage of the PN-DR Direct-acting Pressure Reducing Valve" and "Adjustment" sections be reviewed.

Problem	Symptom	Cause	Remedy
The secondary pressure does not rise	Pressure does not increase	No steam/air is being supplied	Check the primary/secondary piping and valves of the unit
		The valve at the primary side is closed	
		No motive air is being supplied	Check motive air supply
		The entrance to the screen or strainer is clogged	Clean or blow down
		Flow rate exceeds specifications	Check the flow rate; check the model selection, replace with a more suitable unit if necessary
		It exceeds the adjustable pressure range	Check the model selection, replace with a more suitable unit if necessary
The secondary pressure cannot be adjusted or increases abnormally	Adjustment is difficult and set pressure varies	The flow rate is too low	Check the flow rate; check the model selection, replace with a unit that has a smaller nominal diameter or more a suitable unit if necessary
		Pressure fluctuation at the primary side is large	Check the primary pressure; check the model selection, replace with a more suitable unit if necessary
		Buildup on the valve stem prevents smooth movement through the spacer	Clean and inspect the valve stem and spacer

Continued on the next page

Problem	Symptom	Cause	Remedy
The secondary pressure cannot be adjusted or increases abnormally	Adjustment is difficult and set pressure varies	Flow rate fluctuation is too large	Check the flow rate, re-set the pressure; check the model selection, replace with a more suitable unit if necessary
		The motive air pressure fluctuates	Check motive air pressure
	Adjustment is difficult and set pressure varies	The adjustment handle has seized	Replace with a new adjustment handle
		The holes in the spacer are clogged	Clean
		The slide bearing is distorted or damaged	Replace with a new spacer (when replacing the slide bearing or snap ring, these parts need to be replaced as a set with the spacer)
		The bellows is distorted or damaged	Replace with a new bellows
		The selected model is inappropriate for the service conditions (specifications)	Check the model selection, replace with a more suitable unit if necessary
	Upon closing the valves at the secondary side, the secondary pressure abruptly rises as high as the primary pressure	The bypass valve is leaking	Check, clean, and replace with a new valve if necessary
		There is a build-up of dirt on or damage to the main valve or the valve seat	Clean and align
	Hunting or chattering occurs	Occurs at low steam/air demand	The flow rate is too low
Hunting never stops		There is too high a reduction ratio	Use two-stage reduction
		The selected model is inappropriate for the service conditions (specifications)	Check the model selection, replace with a more suitable unit if necessary
Chattering never stops		Condensate is entrained	Install a steam trap; check the piping
		The selected model is inappropriate for the service conditions (specifications)	Check the model selection, replace with a more suitable unit if necessary

Continued on the next page

Problem	Symptom	Cause	Remedy
Abnormal noises	Makes a high-pitched noise	The required pressure reduction exceeds specifications	Use two-stage reduction
		Flow rate exceeds specifications	Check the flow rate; check the model selection, replace with a unit that has larger nominal diameter or a more suitable unit if necessary
		A valve installed close to the reducing valve opens/closes too quickly	Install the valve at as great a distance away as possible

NOTE: When replacing parts with new, use the parts list for reference and replace with parts from the Maintenance Kit, Repair Kit, etc. (Please note that replacement parts are only available in pre-packaged kits.)

TLV EXPRESS LIMITED WARRANTY

Subject to the limitations set forth below, TLV CO., LTD., a Japanese corporation (“**TLV**”), warrants that products which are sold by it, TLV International Inc. (“**TII**”) or one of its group companies excluding TLV Corporation (a corporation of the United States of America), (hereinafter the “**Products**”) are designed and manufactured by TLV, conform to the specifications published by TLV for the corresponding part numbers (the “**Specifications**”) and are free from defective workmanship and materials. The party from whom the Products were purchased shall be known hereinafter as the “**Seller**”. With regard to products or components manufactured by unrelated third parties (the “**Components**”), TLV provides no warranty other than the warranty from the third party manufacturer(s), if any.

Exceptions to Warranty

This warranty does not cover defects or failures caused by:

1. improper shipping, installation, use, handling, etc., by persons other than TLV, TII or TLV group company personnel, or service representatives authorized by TLV; or
2. dirt, scale or rust, etc.; or
3. improper disassembly and reassembly, or inadequate inspection and maintenance by persons other than TLV or TLV group company personnel, or service representatives authorized by TLV; or
4. disasters or forces of nature or Acts of God; or
5. abuse, abnormal use, accidents or any other cause beyond the control of TLV, TII or TLV group companies; or
6. improper storage, maintenance or repair; or
7. operation of the Products not in accordance with instructions issued with the Products or with accepted industry practices; or
8. use for a purpose or in a manner for which the Products were not intended; or
9. use of the Products in a manner inconsistent with the Specifications; or
10. use of the Products with Hazardous Fluids (fluids other than steam, air, water, nitrogen, carbon dioxide and inert gases (helium, neon, argon, krypton, xenon and radon)); or
11. failure to follow the instructions contained in the TLV Instruction Manual for the Product.

Duration of Warranty

This warranty is effective for a period of one (1) year after delivery of Products to the first end user. Notwithstanding the foregoing, asserting a claim under this warranty must be brought within three (3) years after the date of delivery to the initial buyer if not sold initially to the first end user.

ANY IMPLIED WARRANTIES NOT NEGATED HEREBY WHICH MAY ARISE BY OPERATION OF LAW, INCLUDING THE IMPLIED WARRANTIES OF MERCHANTABILITY AND FITNESS FOR A PARTICULAR PURPOSE AND ANY EXPRESS WARRANTIES NOT NEGATED HEREBY, ARE GIVEN SOLELY TO THE INITIAL BUYER AND ARE LIMITED IN DURATION TO ONE (1) YEAR FROM THE DATE OF SHIPMENT BY THE SELLER.

Exclusive Remedy

THE EXCLUSIVE REMEDY UNDER THIS WARRANTY, UNDER ANY EXPRESS WARRANTY OR UNDER ANY IMPLIED WARRANTIES NOT NEGATED HEREBY (INCLUDING THE IMPLIED WARRANTIES OF MERCHANTABILITY AND FITNESS FOR A PARTICULAR PURPOSE), IS **REPLACEMENT**; PROVIDED: (a) THE CLAIMED DEFECT IS

REPORTED TO THE SELLER IN WRITING WITHIN THE WARRANTY PERIOD, INCLUDING A DETAILED WRITTEN DESCRIPTION OF THE CLAIMED DEFECT AND HOW AND WHEN THE CLAIMED DEFECTIVE PRODUCT WAS USED; AND (b) THE CLAIMED DEFECTIVE PRODUCT AND A COPY OF THE PURCHASE INVOICE IS RETURNED TO THE SELLER, FREIGHT AND TRANSPORTATION COSTS PREPAID, UNDER A RETURN MATERIAL AUTHORIZATION AND TRACKING NUMBER ISSUED BY THE SELLER. ALL LABOR COSTS, SHIPPING COSTS, AND TRANSPORTATION COSTS ASSOCIATED WITH THE RETURN OR REPLACEMENT OF THE CLAIMED DEFECTIVE PRODUCT ARE SOLELY THE RESPONSIBILITY OF BUYER OR THE FIRST END USER. THE SELLER RESERVES THE RIGHT TO INSPECT ON THE FIRST END USER'S SITE ANY PRODUCTS CLAIMED TO BE DEFECTIVE BEFORE ISSUING A RETURN MATERIAL AUTHORIZATION. SHOULD SUCH INSPECTION REVEAL, IN THE SELLER'S REASONABLE DISCRETION, THAT THE CLAIMED DEFECT IS NOT COVERED BY THIS WARRANTY, THE PARTY ASSERTING THIS WARRANTY SHALL PAY THE SELLER FOR THE TIME AND EXPENSES RELATED TO SUCH ON-SITE INSPECTION.

Exclusion of Consequential and Incidental Damages

IT IS SPECIFICALLY ACKNOWLEDGED THAT THIS WARRANTY, ANY OTHER EXPRESS WARRANTY NOT NEGATED HEREBY, AND ANY IMPLIED WARRANTY NOT NEGATED HEREBY, INCLUDING THE IMPLIED WARRANTIES OF MERCHANTABILITY AND FITNESS FOR A PARTICULAR PURPOSE, DO NOT COVER, AND NEITHER TLV, TII NOR ITS TLV GROUP COMPANIES WILL IN ANY EVENT BE LIABLE FOR, INCIDENTAL OR CONSEQUENTIAL DAMAGES, INCLUDING, BUT NOT LIMITED TO LOST PROFITS, THE COST OF DISASSEMBLY AND SHIPMENT OF THE DEFECTIVE PRODUCT, INJURY TO OTHER PROPERTY, DAMAGE TO BUYER'S OR THE FIRST END USER'S PRODUCT, DAMAGE TO BUYER'S OR THE FIRST END USER'S PROCESSES, LOSS OF USE, OR OTHER COMMERCIAL LOSSES. WHERE, DUE TO OPERATION OF LAW, CONSEQUENTIAL AND INCIDENTAL DAMAGES UNDER THIS WARRANTY, UNDER ANY OTHER EXPRESS WARRANTY NOT NEGATED HEREBY OR UNDER ANY IMPLIED WARRANTY NOT NEGATED HEREBY (INCLUDING THE IMPLIED WARRANTIES OF MERCHANTABILITY AND FITNESS FOR A PARTICULAR PURPOSE) CANNOT BE EXCLUDED, SUCH DAMAGES ARE EXPRESSLY LIMITED IN AMOUNT TO THE PURCHASE PRICE OF THE DEFECTIVE PRODUCT. THIS EXCLUSION OF CONSEQUENTIAL AND INCIDENTAL DAMAGES, AND THE PROVISION OF THIS WARRANTY LIMITING REMEDIES HEREUNDER TO REPLACEMENT, ARE INDEPENDENT PROVISIONS, AND ANY DETERMINATION THAT THE LIMITATION OF REMEDIES FAILS OF ITS ESSENTIAL PURPOSE OR ANY OTHER DETERMINATION THAT EITHER OF THE ABOVE REMEDIES IS UNENFORCEABLE, SHALL NOT BE CONSTRUED TO MAKE THE OTHER PROVISIONS UNENFORCEABLE.

Exclusion of Other Warranties

THIS WARRANTY IS IN LIEU OF ALL OTHER WARRANTIES, EXPRESS OR IMPLIED, AND ALL OTHER WARRANTIES, INCLUDING BUT NOT LIMITED TO THE IMPLIED WARRANTIES OF MERCHANTABILITY AND FITNESS FOR A PARTICULAR PURPOSE, ARE EXPRESSLY DISCLAIMED.

Severability

Any provision of this warranty which is invalid, prohibited or unenforceable in any jurisdiction shall, as to such jurisdiction, be ineffective to the extent of such invalidity, prohibition or unenforceability without invalidating the remaining provisions hereof, and any such invalidity, prohibition or unenforceability in any such jurisdiction shall not invalidate or render unenforceable such provision in any other jurisdiction.

Service

For Service or Technical Assistance: Contact your TLV representative or your regional TLV office.

In Europe:

TLV EURO ENGINEERING GmbH

Daimler-Benz-Straße 16-18, 74915 Waibstadt, **Germany**

Tel: [49]-(0)7263-9150-0
Fax: [49]-(0)7263-9150-50

TLV EURO ENGINEERING UK LTD.

Units 7 & 8, Furlong Business Park, Bishops Cleeve, Gloucestershire GL52 8TW, **U.K.**

Tel: [44]-(0)1242-227223
Fax: [44]-(0)1242-223077

TLV EURO ENGINEERING FRANCE SARL

Parc d'Ariane 2, bât. C, 290 rue Ferdinand Perrier, 69800 Saint Priest, **France**

Tel: [33]-(0)4-72482222
Fax: [33]-(0)4-72482220

In North America:

TLV CORPORATION

13901 South Lakes Drive, Charlotte, NC 28273-6790, **U.S.A.**

Tel: [1]-704-597-9070
Fax: [1]-704-583-1610

In Mexico and Latin America:

TLV ENGINEERING S. A. DE C. V.

Av. Jesús del Monte 39-B-1001, Col. Hda. de las Palmas, Huixquilucan, Edo. de México, 52763, **Mexico**

Tel: [52]-55-5359-7949
Fax: [52]-55-5359-7585

In Oceania:

TLV PTY LIMITED

Unit 8, 137-145 Rooks Road, Nunawading, Victoria 3131, **Australia**

Tel: [61]-(0)3-9873 5610
Fax: [61]-(0)3-9873 5010

In East Asia:

TLV PTE LTD

36 Kaki Bukit Place, #02-01/02, **Singapore** 416214

Tel: [65]-6747 4600
Fax: [65]-6742 0345

TLV SHANGHAI CO., LTD.

Room 5406, No. 103 Cao Bao Road, Shanghai, **China** 200233

Tel: [86]-(0)21-6482-8622
Fax: [86]-(0)21-6482-8623

TLV ENGINEERING SDN. BHD.

No.16, Jalan MJ14, Taman Industri Meranti Jaya, 47120 Puchong, Selangor, **Malaysia**

Tel: [60]-3-8065-2928
Fax: [60]-3-8065-2923

TLV PRIVATE LIMITED

252/94 (K-L) 17th Floor, Muang Thai-Phatra Complex Tower B, Rachadaphisek Road, Huaykwang, Bangkok 10310, **Thailand**

Tel: [66]-2-693-3799
Fax: [66]-2-693-3979

TLV INC.

#302-1 Bundang Technopark B, 723 Pangyo-ro, Bundang, Seongnam, Gyeonggi, 13511, **Korea**

Tel: [82]-(0)31-726-2105
Fax: [82]-(0)31-726-2195

In the Middle East:

TLV ENGINEERING FZCO

Building 2W, No. M002, PO Box 371684, Dubai Airport Free Zone, Dubai, **UAE**

Email: sales-me@tlv.co.jp

In Other Countries:

TLV INTERNATIONAL, INC.

881 Nagasuna, Noguchi, Kakogawa, Hyogo 675-8511, **Japan**

Tel: [81]-(0)79-427-1818
Fax: [81]-(0)79-425-1167

Manufacturer:

TLV CO., LTD.

881 Nagasuna, Noguchi, Kakogawa, Hyogo 675-8511, **Japan**

Tel: [81]-(0)79-422-1122
Fax: [81]-(0)79-422-0112