



COSPECT® PNEUMATIC CONTROL VALVE FOR STEAM

MODEL PN-COS-16

REMOTELY CONTROLLABLE PNEUMATICALLY ACTUATED CONTROL VALVE

Features

The PN-COS is a pneumatic control valve designed for remotely controlling steam pressure based on the structure of the TLV COS pressure reducing valve. As it includes integrated screens, separator, and steam trap, it also conditions steam quality, and is suitable for use in steam heating processes.*

1. The rapid response pneumatic actuator precisely adjusts the valve position to ensure accurate pressure control.
2. Built-in cyclone separator, with condensate separation efficiency as high as 98%, and self modulating free float steam trap provide dry, high-quality steam supply.
3. Large surface area integral screens for pilot valve and main valve extend trouble-free service.
4. Combining with a controller and an electropneumatic transducer enables automatic PID operation.
5. When combined with an air regulator it can be used as a pressure reducing valve to set secondary pressure remotely, and 2 point pressure switching is possible as well.
6. By adjusting the internal spring load, steam can continue to be supplied at the required lowest set pressure even with motive air cut off (emergency case).

* Can be used to control processes temperature if desired temperature is controllable using secondary pressure within the Adjustable Pressure Range.



Specifications

Model	PN-COS-16
Connection	Flanged
Size (mm)	15, 20, 25, 40, 50
Max. Operating Pressure (MPaG) PMO	1.6
Max. Operating Temperature (°C) TMO	220
Primary Pressure Range (MPaG)	0.2 – 1.6
Adjustable Pressure Range (all conditions must be met)	Within 10 – 84% of primary pressure but with a minimum pressure of 0.03 MPaG
	Max. pressure : [Motive air pressure minus 0.1] MPaG
	Differential Pressure between 0.07 – 0.85 MPa
Minimum Adjustable Flow Rate	5% of rated flow rate
Motive Medium	Oil-free air, filtered to 5 μm
Required Motive Air Pressure	[Desired secondary pressure + 0.1] MPaG or higher (but not exceeding 1.6 MPaG)

PRESSURE SHELL DESIGN CONDITIONS (NOT OPERATING CONDITIONS): Maximum Allowable Pressure (MPaG) PMA: 1.6 1 MPa = 10.197 kg/cm²
Maximum Allowable Temperature (°C) TMA: 220



To avoid abnormal operation, accidents or serious injury, DO NOT use this product outside of the specification range. Local regulations may restrict the use of this product to below the conditions quoted.

Configuration

No.	Description	Material	JIS	ASTM/AISI*
①	Main Body	Cast Iron	FC250	A126 Cl.B
②	Trap Body	Cast Iron	FC250	A126 Cl.B
③	Trap Cover	Cast Iron	FC250	A126 Cl.B
④	Separator	Cast Stainless Steel	—	—
⑤	Float	Stainless Steel	—	—
⑥	Float Cover	Cast Iron	—	—
⑦	Trap Valve Seat	Stainless Steel	—	—
⑧	Separator Screen	Stainless Steel	—	—
⑨	Main Valve Seat	Stainless Steel	—	—
⑩	Main Valve	Stainless Steel	—	—
⑪	Main Valve Holder	Stainless Steel	—	—
⑫	Piston	Cast Stainless Steel	—	—
⑬	Cylinder	Stainless Steel	—	—
⑭	Pilot Screen	Stainless Steel	—	—
⑮	Pilot Screen Holder	Carbon Steel	S25C	A1025
⑯	Pilot Body	Ductile Cast Iron	FCD450	A536
⑰	Piston Guide	15 - 25 mm	Stainless Steel	—
		40, 50 mm	Cast Stainless Steel	—
⑱	Pilot Valve	Stainless Steel	—	—
⑲	Pilot Valve Seat	Stainless Steel	—	—
⑳	Diaphragm	Stainless Steel	—	—
㉑	Diaphragm Support	Brass	—	—
㉒	Spring Housing	Cast Stainless Steel	—	A351 Gr.CF8
㉓	Coil Spring	Carbon Steel	—	—
㉔	Adjustment Screw	Carbon Steel	—	—
㉕	Packing Retainer	Stainless Steel	—	—
㉖	Spanner Cap	Die Cast Aluminium	—	—
㉗	Plug - Sensing Line Port	Carbon Steel	SS400	A6
㉘	Nameplate	Stainless Steel	—	—

* Equivalent

Contact TLV for available replacement parts. All gaskets are PTFE.

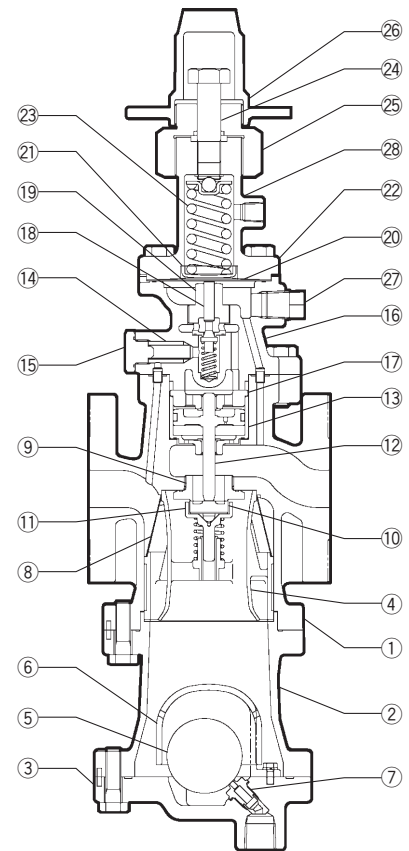

Cv Values

	Nominal Valve Size (mm)				
	15	20	25	40	50
Cv (US)	3.8	6.9	11.1	24.0	37.2
Cv (UK)	3.2	5.7	9.2	20.0	31.0
Kvs (DIN)	3.3	5.9	9.5	20.6	31.9



The Cv & Kvs values shown are for the valve in the full fail open position. These values are not to be used for PN-COS sizing, and instead may be used as one of the factors in calculations for safety valve selection.

Capacity Table

With internal (factory standard) or external (option) secondary pressure-sensing channel or line (kg/h)

Primary Steam Press. (MPaG)	Secondary (Set) Steam Pressure (MPaG)		Nominal Valve Size (mm)				
	Internal Channel	External Line (option)	15	20	25	40	50
0.2	*0.13	*0.13	170	240	340	670	920
	0.11	0.11	180	260	370	720	990
	0.1	**0.03 - 0.1	185	270	380	730	1010
	0.07		60	160	360	700	1000
	**0.03		50	140	340	660	990
0.3	*0.23	*0.23	190	280	400	710	1090
	0.2	0.2	200	290	430	800	1240
	0.15	**0.03 - 0.15	210	310	450	880	1370
	0.1		80	190	400	840	1300
	**0.03		50	140	340	740	1150
0.4	*0.33	*0.33	200	290	410	800	1250
	0.3	3	220	310	450	920	1420
	0.25	0.25	230	320	480	1040	1610
	0.2	**0.04 - 0.2	240	350	520	1130	1750
	0.1		80	280	440	960	1490
	**0.04		60	150	390	850	1310
0.5	*0.42	*0.42	220	320	370	940	1460
	0.4	0.4	240	340	470	1030	1590
	0.3	0.3	260	380	590	1270	1980
	0.25	**0.05 - 0.25	270	400	620	1350	2080
	0.15		170	320	520	1120	1730
	**0.05		60	150	410	890	1380
0.6	*0.5	*0.5	250	350	520	1120	1740
	0.4	0.4	280	410	660	1420	2210
	0.35	0.35	290	440	690	1500	2330
	0.3	**0.06 - 0.3	300	460	720	1560	2420
	0.15		170	320	480	1030	1600
	**0.06		60	150	420	920	1420
0.7	*0.58	*0.58	250	370	600	1300	2020
	0.5	0.5	290	450	720	1560	2420
	0.4	0.4	330	500	800	1720	2670
	0.35	**0.07 - 0.35	350	510	820	1780	2750
	0.2		200	380	610	1310	2040
	**0.07		70	230	430	930	1450
0.8	*0.67	*0.67	280	410	670	1440	2230
	0.6	0.6	300	480	780	1680	2610
	0.5	0.5	340	540	870	1890	2930
	0.4	**0.08 - 0.4	400	570	920	1990	3090
	0.2		200	380	610	1310	2040
	**0.08		70	160	410	900	1390
1.0	*0.84	*0.84	310	500	810	1750	2720
	0.7	0.7	390	630	1010	2180	3380
	0.6	0.6	470	670	1080	2340	3620
	0.5	**0.15 - 0.5	500	700	1120	2420	3750
	0.3		300	460	740	1600	2480
	**0.15		170	320	480	970	1510
1.2	*1.0	*1.0	350	610	980	2110	3270
	0.8	0.8	500	760	1230	2650	4110
	0.7	0.7	570	800	1290	2780	4310
	0.6	**0.35 - 0.6	600	820	1320	2850	4420
	0.5		500	680	1090	2370	3670
	**0.35		360	550	890	1930	2980
1.3	*1.09	*1.09	360	650	1040	2250	3490
	1.0	1.0	410	740	1190	2560	3970
	0.8	0.8	470	850	1360	2950	4570
	0.65	**0.45 - 0.65	480	880	1410	3060	4740
	0.55		400	730	1180	2550	3950
	**0.45		320	580	940	2020	3140
1.4	*1.17	*1.17	410	700	1120	2430	3760
	1.0	1.0	540	840	1360	2940	4550
	0.8	0.8	670	980	1490	3220	4990
	0.7	**0.55 - 0.7	730	1050	1520	3280	5090
	0.6		600	840	1240	2690	4170
	**0.55		550	770	1130	2450	3790
1.6	*1.34	*1.34	470	790	1270	2740	4250
	1.0	1.0	730	1100	1650	3560	5520
	0.9	0.9	790	1200	1750	3650	5660
	0.8	**0.75 - 0.8	880	1300	2000	3710	5750
	**0.75		820	1250	1800	3400	5260

* Maximum adjustable secondary pressure ** Minimum adjustable secondary pressure

1 MPa = 10.197 kg/cm²

Dimensions

● **PN-COS-16 Flanged**

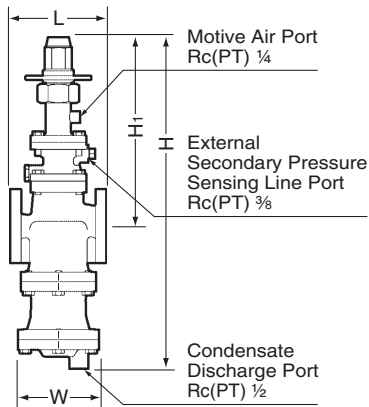

PN-COS-16 Flanged (mm)

Size	L				H	H ₁	W	Weight* (kg)
	ASME Class							
	125FF	(150RF)	250RF	(300RF)				
(15)	—	170	—	170	537	327	105	16
(20)	—	182	—	182				17
25	176	188	188	192	564	324	150	22
40	209	220	222	224	614	344	165	28
50	255	255	260	261	677	357	195	44

() No ASME standard exists for cast iron; machined to fit steel flanges
 Class 125 FF can connect to 150 RF, 250 RF can connect to 300 RF
 Other standards available, but length and weight may vary
 * Weight is for ASME Class 300 RF

Trap Discharge Capacity

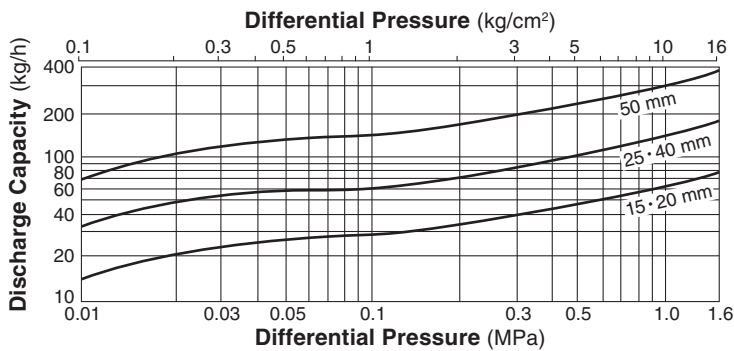

1. The discharge capacity is the maximum continuous condensate discharge 6 °C below saturated steam temperature.
2. The differential pressure is the difference between the PN-COS inlet and its trap outlet pressure.



DO NOT use this product under conditions that exceed maximum differential pressure, as condensate backup will occur!

Usage Examples

As a Control Valve

Automatic PID Control System (Pressure Control)

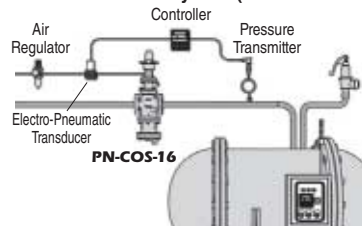

As a Pressure Reducing Valve

Manual Remote System

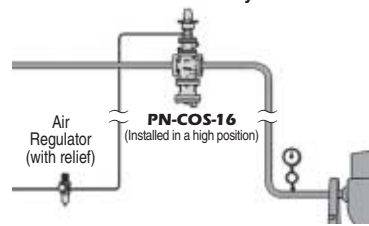

Automatic PID Control System (Temperature Control*)

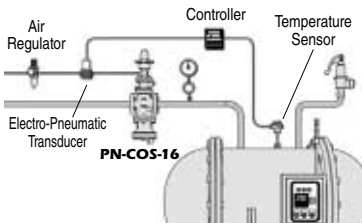

2 Point Pressure Switching

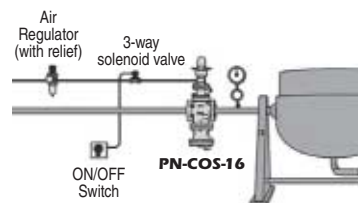

* Can be used to control process temperature if desired temperature is controllable using secondary pressure within the Adjustable Pressure Range.

For explanation purposes only, not intended as installation designs.

Option

<p>Pressure Gauge Unit</p>	<p>Replaces the standard screen holder plug to enable installation of a pressure gauge of the user's choice. Primary side: M16 holder plug (male/female), BSP/Rc(PT)/NPT 3/8. An elbow is required for pressure gauge installation. Secondary side: Rc(PT) 3/8 mounting port for elbow and pressure gauge installation.</p> <hr/> <p>Elbows, pressure gauge and connecting parts must be purchased separately.</p>
----------------------------	--

• Configuration

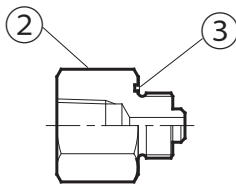

• Installation Example

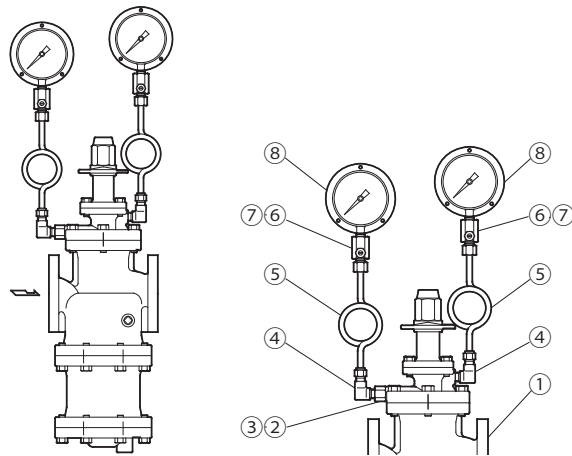

NOTE: For explanation purposes, a siphon tube style pressure gauge will be used. However, the instructions also apply to cooling tower-style pressure gauges.

No.	Part Name	No.	Part Name
1	Valve Body	5	Siphon Tube*
2	Holder Plug	6	Dampener*
3	Holder Plug Gasket	7	Dampener Gasket*
4	Elbow (male/female)*	8	Pressure Gauge*

* Purchase separately

Manufacturer
TLV CO., LTD.
 Kakogawa, Japan
is approved by LRQA Ltd. to ISO 9001/14001

