

INSTRUCTION MANUAL

Keep this manual in a safe place for future reference

TLV THERMODYNAMIC STEAM TRAPS HR-A SERIES

PowerDyne®



Manufacturer

TLV® CO., LTD.

881 Nagasuna, Noguchi, Kakogawa, Hyogo 675-8511, Japan
Tel: [81]-(0)79-422-1122 Fax: [81]-(0)79-422-0112

Copyright (C) 2015 by TLV Co., Ltd. All rights reserved.

Introduction

Before beginning installation or maintenance, please read this manual to ensure correct use of the product. Keep the manual in a safe place for future reference.

Models HR80A, HR150A and HR260A can be used without adjustment for small or medium capacity applications such as the drainage of high pressure and temperature steam mains and turbines. Pressure range of HR80A: 0.8 - 8 MPaG (115 - 1150 psig), HR150A: 1.6 - 15 MPaG (230 - 2100 psig), HR260A: 1.6 - 26 MPaG (230 - 3700 psig). HR260A is suitable for supercritical steam.

1 MPa = 10.197 kg/cm², 1 bar = 0.1 MPa

For products with special specifications or with options not included in this manual, contact TLV for instructions.

The contents of this manual are subject to change without notice.

1. Safety Considerations

- Read this section carefully before use and be sure to follow the instructions.
- Installation, inspection, maintenance, repairs, disassembly, adjustment and valve opening/closing should be carried out only by trained maintenance personnel.
- The precautions listed in this manual are designed to ensure safety and prevent equipment damage and personal injury. For situations that may occur as a result of erroneous handling, three different types of cautionary items are used to indicate the degree of urgency and the scale of potential damage and danger: DANGER, WARNING and CAUTION.
- The three types of cautionary items above are very important for safety; be sure to observe all of them, as they relate to installation, use, maintenance, and repair. Furthermore, TLV accepts no responsibility for any accidents or damage occurring as a result of failure to observe these precautions.

 Indicates a DANGER, WARNING or CAUTION item.

 **DANGER** Indicates an urgent situation that poses a threat of death or serious injury.

 **WARNING** Indicates that there is a potential threat of death or serious injury.

 **CAUTION** Indicates that there is a possibility of injury, or equipment/product damage.

 CAUTION	Install properly and DO NOT use this product outside the recommended operating pressure, temperature and other specification ranges. Improper use may result in such hazards as damage to the product or malfunctions, which may lead to serious accidents. Local regulations may restrict the use of this product to below the conditions quoted.
	Do not subject the trap to condensate loads that exceed its discharge capacity. Failure to observe this precaution may lead to condensate accumulation upstream of the trap, resulting in reduced equipment performance or damage to the equipment.
	Use hoisting equipment for heavy objects (weighing approximately 20 kg or more). Failure to do so may result in back strain or other injury if the object should fall.

Continued on next page

 CAUTION	Take measures to prevent people from coming into direct contact with product outlets. Failure to do so may result in burns or other injury from the discharge of fluids.
	When disassembling or removing the product, wait until the internal pressure equals atmospheric pressure and the surface of the product has cooled to room temperature. Disassembling or removing the product when it is hot or under pressure may lead to discharge of fluids, causing burns, other injuries or damage.
	Be sure to use only the recommended components when repairing the product, and NEVER attempt to modify the product in any way. Failure to observe these precautions may result in damage to the product or burns or other injury due to malfunction or the discharge of fluids.
	Use only under conditions in which no freeze-up will occur. Freezing may damage the product, leading to fluid discharge, which may cause burns or other injury.
	Use under conditions in which no water hammer will occur. The impact of water hammer may damage the product, leading to fluid discharge, which may cause burns or other injury.

2. Specifications

Refer to the product nameplate for detailed specifications.

- A Model
- B Nominal Diameter
- C Maximum Allowable Pressure*
- D Maximum Allowable Temperature* TMA
- E Maximum Operating Pressure
- F Maximum Operating Temperature TMO
- G Production Lot No.
- H Valve No.**

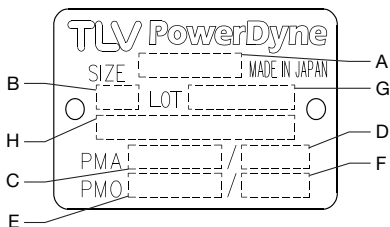

Minimum Operating Pressure: 0.8 MPaG (115 psig) (HR80A); 1.6 MPaG (230 psig) (HR150A, HR260A)
 Maximum Allowable Back Pressure: 50% of inlet pressure

* Maximum allowable pressure (PMA) and maximum allowable temperature (TMA) are PRESSURE SHELL DESIGN CONDITIONS, **NOT** OPERATING CONDITIONS.

** "Valve No." is displayed for products with options. This item is omitted from the nameplate when there are no options.



To avoid malfunctions, product damage, accidents or serious injury, install properly and DO NOT use this product outside the specification range. Local regulations may restrict the use of this product to below the conditions quoted.

3. Configuration

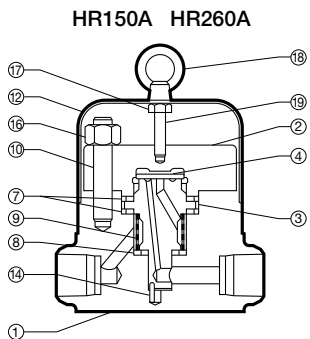
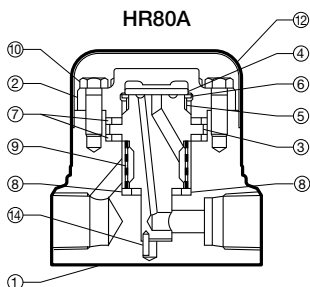

No.	Description	M*	R*	No.	Description	M*	R*
1	Body	-	-	11	Nameplate (not shown)	-	-
2	Cover	-	✓	12	Cap	-	-
3	Module Valve Seat	-	✓	13	Set Screw (not shown)	-	-
4	Disc	-	✓	14	Guide Pin	-	✓
5	Air Vent Ring	-	✓	15	Flange	-	-
6	Disc Holder Ring	-	✓	16	Cover Nut	-	-
7	Module Gasket (large)	✓	✓	17	Hexagon Nut	-	-
8	Module Gasket (small)	✓	✓	18	Eye Nut	-	-
9	Screen	-	✓	19	Spacer	-	-
10	Cover Bolt	-	-				

M = Maintenance Kit R = Repair Kit

4. Proper Installation



- Installation, inspection, maintenance, repairs, disassembly, adjustment and valve opening/closing should be carried out only by trained maintenance personnel.
- Take measures to prevent people from coming into direct contact with product outlets.
- Install for use under conditions in which no freeze-up will occur.
- Install for use under conditions in which no water hammer will occur.

NOTE: For socket weld connections, use electric welding with a single pass. As internal parts are not damaged by a single welding pass, there is no need to remove them before welding.

1. The trap can be installed either horizontally or vertically, but make sure the arrow on the trap points in the direction of flow.
2. Before installation, be sure to remove all protective seals.
3. Before installing the trap, blow out the inlet piping to remove all dirt and oil.
4. Install the trap in the lowest part of the pipeline or equipment so the condensate flows naturally into the trap by gravity. The inlet pipe should be as short and have as few bends as possible.
5. Support the pipes properly within 800 mm (2.5 ft) on either side of the trap.
6. Install a bypass valve to discharge condensate, and inlet and outlet valves to isolate the trap in the event of trap failure or maintenance.
7. Install a check valve at the trap outlet whenever more than one trap is connected to the condensate collection pipeline.
8. In order to avoid excessive back pressure, make sure the discharge pipes are large enough; (the outlet back pressure allowance should be no more than 50% of the inlet steam pressure).
9. We recommend unions to facilitate connection and disconnection of screwed models.

5. Piping Arrangement

Check to make sure that the pipes connected to the trap have been installed properly.

1. Is the pipe diameter suitable?
2. Has sufficient space been secured for maintenance?
3. Have maintenance valves been installed at inlet and outlet? If the outlet is subject to back pressure, has a check valve been installed?
4. Is the inlet pipe as short as possible, with as few bends as possible, and installed so that the condensate will flow naturally down into the trap?
5. Has the piping work been done properly as shown in the table below?

Requirement	Correct	Incorrect
Install a catchpot with the proper diameter.		<p>Diameter is too small.</p>
Make sure the flow of condensate is not obstructed.		<p>Diameter is too small and inlet protrudes into pipe.</p>
To prevent rust and scale from flowing into the trap, connect the inlet pipe 25 - 50 mm (1 - 2 in) above the base of the T - pipe.		<p>Rust and scale flow into the trap with the condensate.</p>
When installing on the blind end, make sure nothing obstructs the flow of condensate.		<p>Condensate collects in the pipe.</p>

6. Start-up Procedure

IMPORTANT START-UP PROCEDURE

To ensure proper operation, slowly open the inlet valve slightly. Initially **OPEN THE VALVE ONLY 1/32 TURN** in order to supply steam to the trap very slowly, then **WAIT FOR AT LEAST 30 SECONDS** for air to vent before fully opening the inlet valve.

7. Operational Check

A visual inspection can be carried out to aid in determining the necessity for immediate maintenance or repair, if the trap is open to atmosphere. If the trap does not discharge to atmosphere, use diagnostic equipment such as TLV TrapMan or Pocket TrapMan (within its pressure and temperature measuring range).

Normal:	Condensate is discharged in a short blast followed by a longer period of no drainage. During the discharge, flash steam may be seen. A small amount of flash steam may be visible after the discharge.
Blocked: (Discharge Impossible)	No condensate is discharged. The trap is quiet and makes no noise. The surface temperature of the trap is low.
Blowing:	Live steam continually flows from the outlet, and there is a continuous metallic sound.
Steam Leakage:	Live steam is discharged through the trap outlet together with condensate, accompanied by a high-pitched sound.
Chattering:	The trap does not close properly. Steam is discharged from the trap in short rapid bursts.

(When conducting a visual inspection, flash steam is sometimes mistaken for steam leakage. For this reason, the use of a steam trap diagnostic instrument such as TLV TrapMan is highly recommended.)

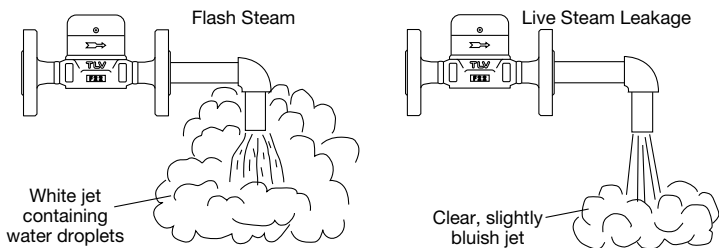

8. Inspection and Maintenance

Operational inspections should be performed at least twice per year, or as called for by trap operating conditions. Steam trap failure may result in temperature drop in the equipment, poor product quality or losses due to steam leakage.



- Installation, inspection, maintenance, repairs, disassembly, adjustment and valve opening/closing should be carried out only by trained maintenance personnel.

- Before attempting to open the trap, close the inlet and outlet isolating valves and wait until the trap has cooled completely. Failure to do so may result in burns.
- Be sure to use the proper components and NEVER attempt to modify the product.

Continued on next page

Parts Inspection Procedure

Sealing surfaces	Check for damage or dirt on the sealing surfaces
Screen	Check for clogging or corrosion damage
Bimetal ring (HR80A)	Check for rust, scale, oil film, warping or damage
Disc holder (HR80A)	Check for rust, scale, oil film, warping or damage
Disc	Check for wear and damage, scratches, on the surface where it contacts the valve seat, and dirt or oil film
Module valve seat	Check discharge channel and grooves for rust and scale inside
Body, Cover	Check inside for erosion, dirt, grease, rust or scale

Disassembly/Reassembly (to reassemble, follow procedures in reverse)

Part & No.	During disassembly	During reassembly
Cap 12 Eye Nut 18	Remove the set screw (HR80A) or the eye nut and then the cap.	Adjust length of spacer, if necessary. (HR150A, HR260A)
Cover bolt 10 or Cover nut 16 Cover 2	Use a socket wrench to remove bolts or nuts at diagonal position sequentially. Apply liquid penetrant for at least 5 minutes to loosen the bolts or nuts, if necessary. Lift up and remove cover.	Tighten bolts or nuts at diagonal position sequentially after having applied antiseize to the threads and threaded bolt holes. It is recommended to use new bolts and nuts for the assembly. Tighten to the proper torque.
Module gasket 7 (large)	Remove the gasket and clean the sealing surfaces.	Replace with a new gasket even if no damage can be seen.
Disc 4	Remove, being careful not to scratch the lapped surface.	Make sure that the seat surface (the lapped side with groove) is facing down, toward the valve seat.
Disc holder ring 6 (HR80A)	Remove without bending.	Set on the air vent ring and make sure that it does not sit on the valve seat surface.
Air vent ring 5 (HR80A)	Remove without bending, as it will not return to its proper shape.	Reinsert without bending.
Module valve seat 3 and Guide pin 14	Remove from the body.	Insert the guide pin into the hole in the body and make sure it fits properly into the respective hole of the module valve seat.
Module gasket 8 (small)	Remove the gasket and clean the sealing surfaces.	Replace with a new gasket even if no damage can be seen.
Screen 9	Be careful not to bend the screen.	Be careful not to bend the screen.

Tightening Torque and Distance Across Flats

Part	N·m (lb-ft)		mm (in)	
	35	(26)	13	($\frac{1}{2}$)
Cover bolt HR80A*	50	(37)	14	($\frac{9}{16}$)
Cover nut HR150A	130	(95)	22	($\frac{7}{8}$)
Cover nut HR260A	280	(205)	27	($1\frac{1}{16}$)

1 N·m \approx 10 kg·cm

* Different cover bolts are used depending on the product. Confirm distance across flats and use it to select the appropriate torque.

If drawings or other special documentation were supplied for the product, any torque given there takes precedence over values shown here.

9. Troubleshooting

If the expected performance is unachievable after installation of the trap, read chapter 4 and chapter 5 again and check the following points for appropriate corrective measures.

Problem	Cause	Remedy
No condensate is discharged (blocked) or discharge is poor	Screen is clogged with rust or scale	Clean
	Air vent ring (bimetal) is broken or worn, causing air-binding (HR80A)	Replace air vent ring (HR80A)
	Disc holder ring is broken or worn, causing air-binding (HR80A)	Replace disc holder ring (HR80A)
	Disc is sticking to valve seat (due to oil, etc.)	Clean
	Steam-locking	Correct piping
	Trap capacity is insufficient	Change to trap of suitable capacity
	Differential pressure is low	Study inlet/outlet pressure, including rise in outlet pipe
Steam leakage or blowing (from valve seat)	Valve closure is obstructed by scale, etc.	Clean or replace screen
	Disc or valve seat is worn	Replace worn parts
	Air vent ring (bimetal) or disc holder ring is broken, obstructing valve closure (HR80A)	Replace air vent ring or disc holder ring (HR80A)
	Back pressure exceeds allowable value	Use within pressure range
	Trap is being used below minimum operating pressure	Use within pressure range
	Disc is sticking to top of cover (due to oil, etc.)	Clean
Valve chattering (Leakage)	Foreign matter or oil film on disc or valve seat	Clean
	Scratches on disc or valve seat	Replace disc or module valve seat
	Disc or valve seat is worn	Replace disc or module valve seat
Leakage from a location other than valve seat (via discharge, or from product body)	Bypass valve is damaged or open	Replace or close bypass valve
	Cover is loose or module gaskets are damaged	Tighten cover or replace module gaskets

NOTE: When replacing parts with new, use the parts list on page 3 for reference, and replace with parts from the Maintenance Kit and/or Repair Kit. Please note that replacement parts are only available as part of a replacement parts kit.

10. TLV® Express Limited Warranty

Subject to the limitations set forth below, TLV Corporation, a North Carolina corporation (“**TLV**”) warrants that products which are sold by it or TLV International, Inc., a Japanese corporation (“**TLI**”), which products (the “**Products**”) are designed and manufactured by TLV Co., Ltd., a Japanese corporation (“**TLVJ**”), conform to the specifications published by TLV for the corresponding part numbers (the “**Specifications**”) and are free from defective workmanship and materials. With regard to products or components manufactured by unrelated third parties (the “**Components**”), TLV provides no warranty other than the warranty from the third party manufacturer(s).

Exceptions To Warranty

This warranty does not cover defects or failures caused by:

1. improper shipping, installation, use, handling, etc., by other than TLV or service representatives authorized by TLV; or
2. dirt, scale or rust, etc.; or
3. improper disassembly and reassembly, or inadequate inspection and maintenance by other than TLV or service representatives authorized by TLV; or
4. disasters or forces of nature; or
5. abuse, abnormal use, accidents or any other cause beyond the control of TLV; or
6. improper storage, maintenance or repair; or
7. operation of the Products not in accordance with instructions issued with the Products or with accepted industry practices; or
8. use for a purpose or in a manner for which the Products were not intended; or
9. use of the Products in a manner inconsistent with the Specifications; or
10. failure to follow the instructions contained in the TLV Instruction Manual for the Product.

Duration Of Warranty

This warranty is effective for a period of the earlier of: (i) three (3) years after delivery of Products to the first end user in the case of sealed SST-Series Products for use in steam pressure service up to 650 psig; (ii) two (2) years after delivery of Products to the first end user in the case of PowerTrap® units; or (iii) one (1) year after delivery of Products to the first end user in the case of all other Products. Notwithstanding the foregoing, asserting a claim under this warranty must be brought by the earlier of one of the foregoing periods, as applicable, or within five (5) years after the date of delivery to the initial buyer if not sold initially to the first end user.

ANY IMPLIED WARRANTIES NOT NEGATED HEREBY WHICH MAY ARISE BY OPERATION OF LAW, INCLUDING THE IMPLIED WARRANTIES OF MERCHANTABILITY AND FITNESS FOR A PARTICULAR PURPOSE AND ANY EXPRESS WARRANTIES NOT NEGATED HEREBY, ARE GIVEN SOLELY TO THE INITIAL BUYER AND ARE LIMITED IN DURATION TO ONE (1) YEAR FROM THE DATE OF SHIPMENT BY TLV.

Exclusive Remedy

THE EXCLUSIVE REMEDY UNDER THIS WARRANTY, UNDER ANY EXPRESS WARRANTY OR UNDER ANY IMPLIED WARRANTIES NOT NEGATED HEREBY (INCLUDING THE IMPLIED WARRANTIES OF MERCHANTABILITY AND FITNESS FOR A PARTICULAR PURPOSE), IS **REPLACEMENT**; PROVIDED: (a) THE CLAIMED DEFECT IS REPORTED TO TLV IN WRITING WITHIN THE APPLICABLE WARRANTY PERIOD, INCLUDING A DETAILED WRITTEN DESCRIPTION OF THE CLAIMED DEFECT AND HOW AND WHEN THE CLAIMED DEFECTIVE PRODUCT WAS USED; AND (b) THE CLAIMED DEFECTIVE PRODUCT AND A COPY OF THE PURCHASE INVOICE IS RETURNED TO TLV, FREIGHT AND TRANSPORTATION COSTS PREPAID, UNDER A RETURN MATERIAL AUTHORIZATION AND TRACKING NUMBER ISSUED BY TLV. ALL LABOR COSTS, SHIPPING COSTS, AND TRANSPORTATION COSTS ASSOCIATED WITH THE RETURN OR REPLACEMENT OF THE CLAIMED DEFECTIVE PRODUCT ARE SOLELY THE RESPONSIBILITY OF BUYER OR THE FIRST END USER. TLV RESERVES THE RIGHT TO INSPECT ON THE FIRST END USER'S SITE ANY PRODUCTS

CLAIMED TO BE DEFECTIVE BEFORE ISSUING A RETURN MATERIAL AUTHORIZATION. SHOULD SUCH INSPECTION REVEAL, IN TLV'S REASONABLE DISCRETION, THAT THE CLAIMED DEFECT IS NOT COVERED BY THIS WARRANTY, THE PARTY ASSERTING THIS WARRANTY SHALL PAY TLV FOR THE TIME AND EXPENSES RELATED TO SUCH ON-SITE INSPECTION.

Exclusion Of Consequential And Incidental Damages

IT IS SPECIFICALLY ACKNOWLEDGED THAT THIS WARRANTY, ANY OTHER EXPRESS WARRANTY NOT NEGATED HEREBY, AND ANY IMPLIED WARRANTY NOT NEGATED HEREBY, INCLUDING THE IMPLIED WARRANTIES OF MERCHANTABILITY AND FITNESS FOR A PARTICULAR PURPOSE, DO NOT COVER, AND NEITHER TLV, TII NOR TLVJ WILL IN ANY EVENT BE LIABLE FOR, INCIDENTAL OR CONSEQUENTIAL DAMAGES, INCLUDING, BUT NOT LIMITED TO LOST PROFITS, THE COST OF DISASSEMBLY AND SHIPMENT OF THE DEFECTIVE PRODUCT, INJURY TO OTHER PROPERTY, DAMAGE TO BUYER'S OR THE FIRST END USER'S PRODUCT, DAMAGE TO BUYER'S OR THE FIRST END USER'S PROCESSES, LOSS OF USE, OR OTHER COMMERCIAL LOSSES. WHERE, DUE TO OPERATION OF LAW, CONSEQUENTIAL AND INCIDENTAL DAMAGES UNDER THIS WARRANTY, UNDER ANY OTHER EXPRESS WARRANTY NOT NEGATED HEREBY OR UNDER ANY IMPLIED WARRANTY NOT NEGATED HEREBY (INCLUDING THE IMPLIED WARRANTIES OF MERCHANTABILITY AND FITNESS FOR A PARTICULAR PURPOSE) CANNOT BE EXCLUDED, SUCH DAMAGES ARE EXPRESSLY LIMITED IN AMOUNT TO THE PURCHASE PRICE OF THE DEFECTIVE PRODUCT. THIS EXCLUSION OF CONSEQUENTIAL AND INCIDENTAL DAMAGES, AND THE PROVISION OF THIS WARRANTY LIMITING REMEDIES HEREUNDER TO REPLACEMENT, ARE INDEPENDENT PROVISIONS, AND ANY DETERMINATION THAT THE LIMITATION OF REMEDIES FAILS OF ITS ESSENTIAL PURPOSE OR ANY OTHER DETERMINATION THAT EITHER OF THE ABOVE REMEDIES IS UNENFORCEABLE, SHALL NOT BE CONSTRUED TO MAKE THE OTHER PROVISIONS UNENFORCEABLE.

Exclusion Of Other Warranties

THIS WARRANTY IS IN LIEU OF ALL OTHER WARRANTIES, EXPRESS OR IMPLIED, AND ALL OTHER WARRANTIES, INCLUDING BUT NOT LIMITED TO THE IMPLIED WARRANTIES OF MERCHANTABILITY AND FITNESS FOR A PARTICULAR PURPOSE, ARE EXPRESSLY DISCLAIMED.

Severability

Any provision of this warranty which is invalid, prohibited or unenforceable in any jurisdiction shall, as to such jurisdiction, be ineffective to the extent of such invalidity, prohibition or unenforceability without invalidating the remaining provisions hereof, and any such invalidity, prohibition or unenforceability in any such jurisdiction shall not invalidate or render unenforceable such provision in any other jurisdiction.

TLV CORPORATION

13901 South Lakes Drive, Charlotte, NC 28273-6790, U.S.A.

Tel: [1]-704-597-9070

Fax: [1]-704-583-1610



Manufacturer: TLV CO., LTD.
881 Nagasuna, Noguchi, Kakogawa,
Hyogo 675-8511, **Japan**

Tel: [81]-(0)79-422-1122
Fax: [81]-(0)79-422-0112

Printed on recycled paper.

Rev. 5/2015 (M)