

INSTRUCTION MANUAL

Keep this manual in a safe place for future reference

TLV THERMODYNAMIC STEAM TRAP
MODEL P46S/P21S ver.C

PowerDyne®

P46S/P21S ver.C



(Option)
BD1

Manufacturer

TLV CO., LTD.

881 Nagasuna, Noguchi, Kakogawa, Hyogo 675-8511, **Japan**

Tel: [81]-(0)79-422-1122 Fax: [81]-(0)79-422-0112

Copyright (C) 2015 by TLV Co., Ltd. All rights reserved.

Introduction

Before beginning installation or maintenance, please read this manual to ensure correct use of the product. Keep the manual in a safe place for future reference.

The P46S steam trap can be used without adjustment for small capacity applications between 0.03 and 4.6 MPaG (5 and 650 psig). For best performance over extended periods, it is recommended that the trap be operated at or below 2.1 MPaG (300 psig).

The P21S ver.C steam trap can be used without adjustment for small capacity applications between 0.025* and 2.1 MPaG (3.5* and 300 psig).

These models are suitable for steam mains, branch pipes, tracer lines, etc. In particular, the P21S ver.C is purpose-built for troublesome Copper Tracing applications, whereas the P46S is designed for multi-purpose applications.

* Vertical installation: 0.04 MPaG (6 psig)

1 MPa = 10.197 kg/cm², 1 bar = 0.1 MPa

For products with special specifications or with options not included in this manual, contact TLV for instructions.

The contents of this manual are subject to change without notice.

1. Safety Considerations

- Read this section carefully before use and be sure to follow the instructions.
- Installation, inspection, maintenance, repairs, disassembly, adjustment and valve opening/closing should be carried out only by trained maintenance personnel.
- The precautions listed in this manual are designed to ensure safety and prevent equipment damage and personal injury. For situations that may occur as a result of erroneous handling, three different types of cautionary items are used to indicate the degree of urgency and the scale of potential damage and danger: DANGER, WARNING and CAUTION.
- The three types of cautionary items above are very important for safety; be sure to observe all of them, as they relate to installation, use, maintenance, and repair. Furthermore, TLV accepts no responsibility for any accidents or damage occurring as a result of failure to observe these precautions.



Indicates a DANGER, WARNING or CAUTION item.



DANGER

Indicates an urgent situation that poses a threat of death or serious injury.



WARNING

Indicates that there is a potential threat of death or serious injury.



CAUTION

Indicates that there is a possibility of injury, or equipment/product damage.



CAUTION

Install properly and DO NOT use this product outside the recommended operating pressure, temperature and other specification ranges.

Improper use may result in such hazards as damage to the product or malfunctions, which may lead to serious accidents. Local regulations may restrict the use of this product to below the conditions quoted.

DO NOT subject this product to condensate loads that exceed its discharge capacity. Failure to observe this precaution may lead to condensate accumulation upstream of the trap, resulting in reduced equipment performance or damage to the equipment.

Take measures to prevent people from coming into direct contact with product outlets. Failure to do so may result in burns or other injury from the discharge of fluids.

Continued on next page

 CAUTION	<p>When disassembling or removing the product, wait until the internal pressure equals atmospheric pressure and the surface of the product has cooled to room temperature. Disassembling or removing the product when it is hot or under pressure may lead to discharge of fluids, causing burns, other injuries or damage.</p>
	<p>Be sure to use only the recommended components when repairing the product, and NEVER attempt to modify the product in any way. Failure to observe these precautions may result in damage to the product or burns or other injury due to malfunction or the discharge of fluids.</p>
	<p>Use only under conditions in which no freeze-up will occur. Freezing may damage the product, leading to fluid discharge, which may cause burns or other injury.</p>
	<p>Use under conditions in which no water hammer will occur. The impact of water hammer may damage the product, leading to fluid discharge, which may cause burns or other injury.</p>

2. Specifications Technische Daten Données techniques

Refer to the product nameplate for detailed specifications.

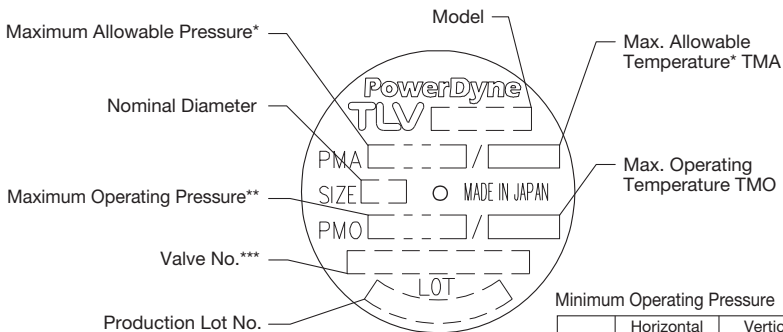

Maximum Allowable Back Pressure: 80% of inlet pressure

	Horizontal	Vertical
P46S	0.03 MPaG (5 psig)	
P21S ver.C	0.025 MPaG (3.5 psig)	0.04 MPaG (6 psig)

* Maximum allowable pressure (PMA) and maximum allowable temperature (TMA) are **PRESSURE SHELL DESIGN CONDITIONS, NOT OPERATING CONDITIONS.**

** P46S : For best performance over extended periods, it is recommended that the trap be operated at or below 2.1 MPaG (300 psig).

*** Valve No. is displayed for products with options. This item is omitted from the nameplate when there are no options.



To avoid malfunctions, product damage, accidents or serious injury, install properly and **DO NOT** use this product outside the specification range. Local regulations may restrict the use of this product to below the conditions quoted.

3. Configuration

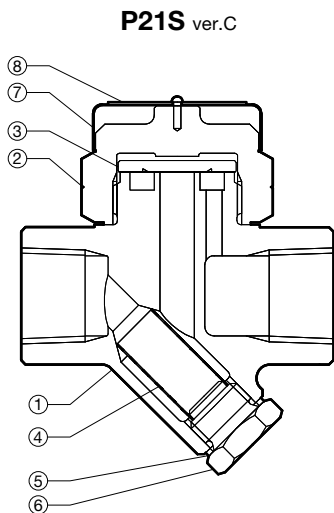
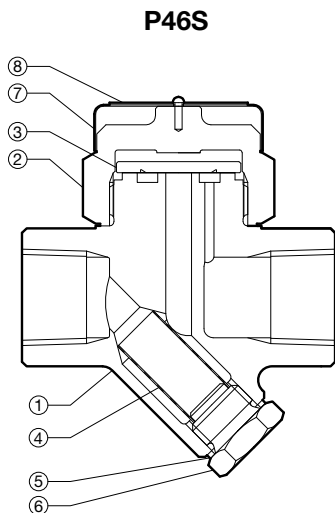

No.	Description	M*	R*	No.	Description	M*	R*
1	Body	-	-	5	Screen Holder Gasket	✓	✓
2	Cover	-	✓	6	Screen Holder	-	-
3	Disc	-	✓	7	Cap	-	✓
4	Screen	-	✓	8	Nameplate	-	✓

* M = Maintenance Kit; R = Repair Kit; replacement parts are available only in their respective kits.

4. Exploded View

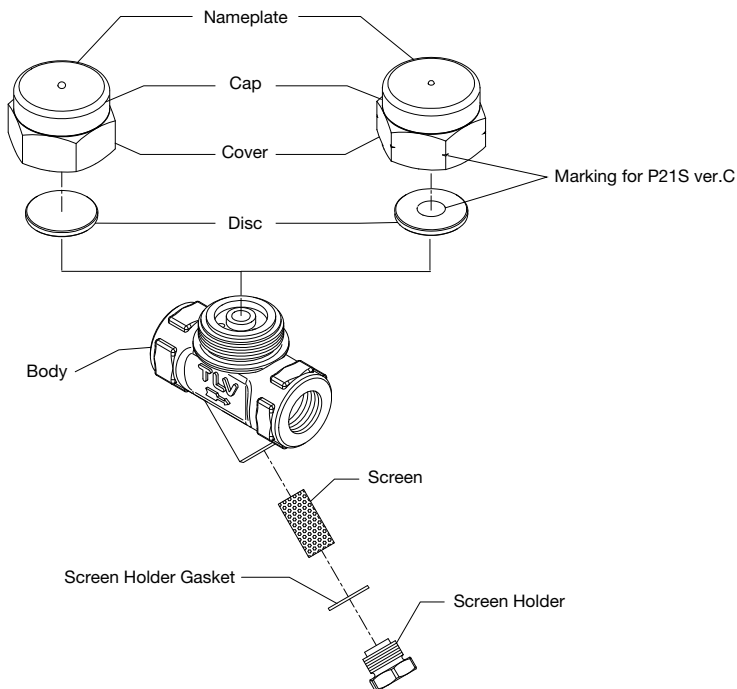

Tightening Torque and Distance Across Flats								
Model	Cover		Screen Holder					
	N-m	(lbf-ft)	mm	(in)	N-m	(lbf-ft)	mm	(in)
P46S P21S ver. C	120	(88)	36	(1 ¹³ / ₃₂)	40	(29)	17	(² / ₃₂)

1 N-m \approx 10 kg-cm

If drawings or other special documentation were supplied for the product, any torque given there takes precedence over values shown here.

5. Proper Installation



CAUTION

• Installation, inspection, maintenance, repairs, disassembly, adjustment and valve opening/closing should be carried out only by trained maintenance personnel.







- Take measures to prevent people from coming into direct contact with product outlets.
- Install for use under conditions in which no freeze-up will occur.
- Install for use under conditions in which no water hammer will occur.

1. The trap can be installed either horizontally or vertically, but make sure the arrow on the trap points in the direction of flow.
2. Before installation, be sure to remove all protective seals.
3. Before installing the trap, blow out the inlet piping to remove all dirt and oil.
4. Install the trap in the lowest part of the pipeline or equipment so the condensate flows naturally into the trap by gravity. The inlet pipe should be as short and have as few bends as possible.
5. Support the pipes properly within 800 mm (2.5 ft) on either side of the trap.
6. Install a bypass valve to discharge condensate, and inlet and outlet valves to isolate the trap in the event of trap failure or maintenance.
7. Install a check valve at the trap outlet whenever more than one trap is connected to the condensate collection pipeline.
8. In order to avoid excessive back pressure, make sure the discharge pipes are large enough; (the outlet back pressure allowance should be no more than 80% of the inlet steam pressure).
9. We recommend unions to facilitate connection and disconnection of the trap.

6. Piping Arrangement

Check to make sure that the pipes connected to the trap have been installed properly.

1. Is the pipe diameter suitable, and has sufficient space been secured for maintenance?
2. Has the trap been installed with the arrow on the body pointing in the direction of flow?
3. Have maintenance valves been installed at the inlet and outlet? If the outlet is subject to back pressure, has a check valve been installed?
4. Is the inlet pipe as short as possible, with as few bends as possible, and installed so that the condensate will flow naturally down into the trap?
5. Has the piping work been done correctly, as shown in the table below?

Requirement	Correct	Incorrect
Install a catchpot of the proper diameter.		 Diameter is too small.
Make sure the flow of condensate is not obstructed.		 Diameter is too small and inlet protrudes into pipe.
To prevent rust and scale from flowing into the trap, connect the inlet pipe 25 - 50 mm (1 - 2 in) above the base of the T - pipe.		 Rust and scale flow into the trap with the condensate.
When installing on the blind end, make sure nothing obstructs the flow of condensate.		 Condensate collects in the pipe.

7. Operational Check

A visual inspection can be carried out to aid in determining the necessity for immediate maintenance or repair, if the trap is open to atmosphere. If the trap does not discharge to atmosphere, use diagnostic equipment such as TLV TrapMan or TLV Pocket TrapMan (within their pressure and temperature measuring range).

Normal:	Condensate is discharged in a short blast followed by a longer period of no drainage. During the discharge, flash steam may be seen. A small amount of flash steam may be visible after the discharge.
Blocked: (Discharge Impossible)	No condensate is discharged. The trap is quiet and makes no noise. The surface temperature of the trap is low.
Blowing:	Live steam continually flows from the outlet, and there is a continuous metallic sound.
Steam Leakage:	Live steam is discharged through the trap outlet together with condensate, accompanied by a high-pitched sound.
Chattering:	The trap does not close properly. Steam is discharged from the trap in short rapid bursts.

(When conducting a visual inspection, flash steam is sometimes mistaken for steam leakage. For this reason, the use of a steam trap diagnostic instrument such as TLV TrapMan is highly recommended.)

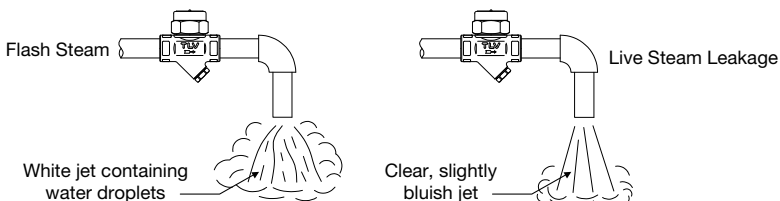

8. Inspection and Maintenance

Operational inspections should be performed at least twice per year, or as called for by trap operating conditions. Steam trap failure may result in temperature drop in the equipment, poor product quality or losses due to steam leakage.



- Installation, inspection, maintenance, repairs, disassembly, adjustment and valve opening/closing should be carried out only by trained maintenance personnel.
- Before attempting to open the trap, close the inlet and outlet isolating valves and wait until the trap has cooled completely. Failure to do so may result in burns.
- Be sure to use the proper components and NEVER attempt to modify the product.

Parts Inspection Procedure	
Body, Cover	Check inside for damage, dirt, grease, oil film, rust or scale
Gaskets	Check for warping or damage
Screen	Check for clogging or corrosion damage
Disc	Check for damage or wear
Valve Seat Surface inside Cover	Check for damage or wear

Disassembly / Reassembly (to reassemble, follow procedures in reverse)		
Part & No.	During Disassembly	During Reassembly
Cover 2	Remove with a socket wrench Cap is not removable as it is riveted to the cover	Coat threads with anti-seize, then tighten to the proper torque (page 4)
Disc 3	Remove, being careful not to scratch the lapped surface	Make sure that the seat surface (the lapped side) is facing down, toward the valve seat
Screen Holder 6	Remove with a socket wrench	Coat threads with anti-seize, then tighten to the proper torque (page 4)
Screen Holder Gasket 5	Remove gasket and clean sealing surfaces	Replace with a new gasket, coat surfaces with anti-seize
Screen 4	Remove without bending	Reinsert without bending

9. Instructions for Plug / Holder Disassembly and Reassembly

The seal on the threaded plugs/holders found on TLV products is formed by a flat metal gasket. There are various installation orientations for the gaskets, such as horizontal, diagonal and downward, and the gasket may be pinched in the thread recesses during assembly.

Instructions for Disassembly and Reassembly

- ① Remove the plug/holder using a tool of the specified size (distance across flats).
- ② The gasket should not be reused. Be sure to replace it with a new gasket.
- ③ Clean the gasket surfaces of the plug/holder and the product body using a rag and/or cleaning agents, then check to make sure the surfaces are not scratched or deformed.

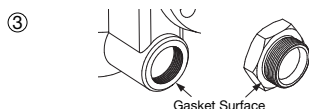

- ④ Coat both the gasket surface of the plug/holder and the threads of the plug/holder with anti-seize, then press the gasket onto the center of the gasket surface of the plug/holder, making sure the anti-seize affixes the gasket tightly to the plug/holder. Check to make sure the gasket is not caught in the recesses of the threads.
- ⑤ Hold the plug/holder upside down to make sure that the anti-seize makes the gasket stick to the plug/holder even when the plug/holder is held upside down.
- ⑥ Screw the plug/holder by hand into the product body while making sure that the gasket remains tightly affixed to the center of the gasket surface of the plug/holder. Make sure the entire gasket is making contact with the gasket surface of the product body. It is important at this point to make sure the gasket is not pinched in the thread recesses of the plug/holder.
- ⑦ Tighten the plug/holder to the proper torque.
- ⑧ Next, begin the supply of steam and check to make sure there is no leakage from the part just tightened. If there is leakage, immediately close the inlet valve and, if there is a bypass valve, take the necessary steps to release any residual pressure. After the surface of the product cools to room temperature, repeat the procedure beginning from step ①.

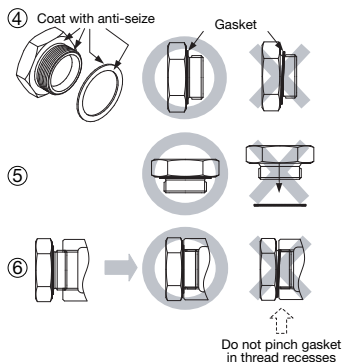

10. Troubleshooting

If the expected performance is unachievable after installation of the trap, read chapter 5 and chapter 6 again and check the following points for appropriate corrective measures.

Problem	Cause	Remedy
No condensate is discharged (blocked) or discharge is poor	Screen is clogged with rust or scale	Clean
	Disc is sticking to valve seat (due to oil, etc.)	Clean
	Steam-locking has occurred	Perform a bypass blow-down, or close the trap inlet valve and allow the trap to cool. Piping correction may also be required
	Trap capacity is insufficient	Change to trap of suitable capacity
	Differential pressure is low	Study inlet/outlet pressure, including rise in outlet pipe
Steam leakage or blowing (from valve seat)	Valve closure is obstructed by scale, etc.	Clean or replace screen
	Disc or valve seat is worn	Replace worn parts
	Back pressure exceeds allowable value	Use within pressure range
	Trap is being used below minimum operating pressure	Use within pressure range
	Disc is sticking to top of cover (due to oil, etc.)	Clean
Valve chattering (Leakage)	Foreign matter or oil film on disc or valve seat	Clean
	Scratches on disc or valve seat	Replace disc or trap
	Disc or valve seat is worn	Replace disc or trap
Leakage from a location other than valve seat	Bypass valve is damaged or open	Replace or close bypass valve
	Cover is loose or sealing surface between cover and body is damaged	Tighten cover, or replace trap
	Inlet and discharge channels may be connected, due to erosion	Replace trap (study trap capacity)
	Screen holder is loose or screen holder gasket is damaged	Tighten screen holder or replace screen holder gasket

NOTE: When replacing parts with new, use the parts list on page 3 for reference, and replace with parts from the Maintenance Kit and/or Repair Kit. Please note that replacement parts are only available as part of a replacement parts kit.

11. Optional Blowdown Valve BD1

- Installation, inspection, maintenance, repairs, disassembly, adjustment and valve opening/closing should be carried out only by trained maintenance personnel.

11.1 Reassembly of Blowdown Valve



- When disassembling or removing the product, wait until the internal pressure equals atmospheric pressure and the surface of the product has cooled to room temperature.

1. Clean the trap, BD1 threads, and sealing surfaces, and apply a small amount of anti-seize.
2. Replace gasket.
3. Carefully place the gasket over the threaded portion, and position carefully so that it does not become off-center.
4. Fasten to the steam trap with the proper torque.

Reassembly Type

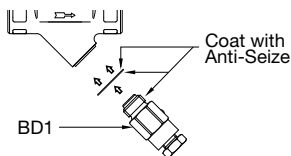

Torque (T) and Distance Across Flats (D)

	① (T): 11 N·m (8 lbf-ft) (D): 14 mm (9/16")
	② (T): 40 N·m (29 lbf-ft) (D): 17 mm (21/32")

11.2 Operation Instructions for BD1

The BD1 Blowdown Valve uses internal pressure to blow out condensate or steam (and scale/dirt in the condensate or steam) from inside the unit to atmosphere.

Note: Do not leave the vicinity while the blowdown valve is in the open position.



- Always wear eye protection and heat-resistant gloves when operating the blowdown valve. Failure to do so may result in burns or other injury.
- When operating the blowdown valve, stand to the side well clear of the outlet to avoid contact with internal fluids that will be discharged. Failure to do so may result in burns or other injury.
- Do not use excessive force when opening the blowdown valve. Such force may break the pin equipped as a valve stopper, causing a blowout from internal pressure resulting in burns or other injury.

1. With two wrenches, firmly hold the BD1 Valve Seat (Screen Holder) ② (see table on previous page for distance across flats) in place while slowly opening the BD1 Valve ① (14 mm, 9/16"). Be careful to avoid contact with fluid that will be discharged through the hole in the center of the blowdown valve as the valve opens.
2. Close the BD1 Valve ① and tighten to a torque of 11 N·m (8 lbf-ft), and confirm that there is no leakage. If leakage continues, dirt or scale may prevent the valve from sealing. Open and blow out again, then try to close once more.

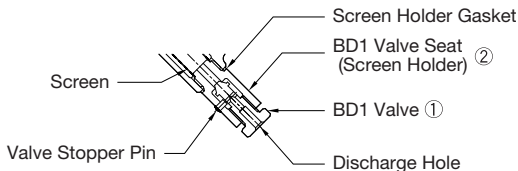

12. TLV® Express Limited Warranty

Subject to the limitations set forth below, TLV Corporation, a North Carolina corporation (“**TLV**”) warrants that products which are sold by it or TLV International, Inc., a Japanese corporation (“**TII**”), which products (the “**Products**”) are designed and manufactured by TLV Co., Ltd., a Japanese corporation (“**TLVJ**”), conform to the specifications published by TLV for the corresponding part numbers (the “**Specifications**”) and are free from defective workmanship and materials. With regard to products or components manufactured by unrelated third parties (the “**Components**”), TLV provides no warranty other than the warranty from the third party manufacturer(s).

Exceptions To Warranty

This warranty does not cover defects or failures caused by:

1. improper shipping, installation, use, handling, etc., by other than TLV or service representatives authorized by TLV; or
2. dirt, scale or rust, etc.; or
3. improper disassembly and reassembly, or inadequate inspection and maintenance by other than TLV or service representatives authorized by TLV; or
4. disasters or forces of nature; or
5. abuse, abnormal use, accidents or any other cause beyond the control of TLV; or
6. improper storage, maintenance or repair; or
7. operation of the Products not in accordance with instructions issued with the Products or with accepted industry practices; or
8. use for a purpose or in a manner for which the Products were not intended; or
9. use of the Products in a manner inconsistent with the Specifications; or
10. failure to follow the instructions contained in the TLV Instruction Manual for the Product.

Duration Of Warranty

This warranty is effective for a period of the earlier of: (i) three (3) years after delivery of Products to the first end user in the case of sealed SST-Series Products for use in steam pressure service up to 650 psig; (ii) two (2) years after delivery of Products to the first end user in the case of PowerTrap® units; or (iii) one (1) year after delivery of Products to the first end user in the case of all other Products. Notwithstanding the foregoing, asserting a claim under this warranty must be brought by the earlier of one of the foregoing periods, as applicable, or within five (5) years after the date of delivery to the initial buyer if not sold initially to the first end user.

ANY IMPLIED WARRANTIES NOT NEGATED HEREBY WHICH MAY ARISE BY OPERATION OF LAW, INCLUDING THE IMPLIED WARRANTIES OF MERCHANTABILITY AND FITNESS FOR A PARTICULAR PURPOSE AND ANY EXPRESS WARRANTIES NOT NEGATED HEREBY, ARE GIVEN SOLELY TO THE INITIAL BUYER AND ARE LIMITED IN DURATION TO ONE (1) YEAR FROM THE DATE OF SHIPMENT BY TLV.

Exclusive Remedy

THE EXCLUSIVE REMEDY UNDER THIS WARRANTY, UNDER ANY EXPRESS WARRANTY OR UNDER ANY IMPLIED WARRANTIES NOT NEGATED HEREBY (INCLUDING THE IMPLIED WARRANTIES OF MERCHANTABILITY AND FITNESS FOR A PARTICULAR PURPOSE), IS **REPLACEMENT**; PROVIDED: (a) THE CLAIMED DEFECT IS REPORTED TO TLV IN WRITING WITHIN THE APPLICABLE WARRANTY PERIOD, INCLUDING A DETAILED WRITTEN DESCRIPTION OF THE CLAIMED DEFECT AND HOW AND WHEN THE CLAIMED DEFECTIVE PRODUCT WAS USED; AND (b) THE CLAIMED DEFECTIVE PRODUCT AND A COPY OF THE PURCHASE INVOICE IS RETURNED TO TLV, FREIGHT AND TRANSPORTATION COSTS PREPAID, UNDER A RETURN MATERIAL AUTHORIZATION AND TRACKING NUMBER ISSUED BY TLV. ALL LABOR COSTS, SHIPPING COSTS, AND TRANSPORTATION COSTS ASSOCIATED WITH THE RETURN OR REPLACEMENT OF THE CLAIMED DEFECTIVE PRODUCT ARE SOLELY THE RESPONSIBILITY OF BUYER OR THE FIRST END USER. TLV RESERVES THE RIGHT TO INSPECT ON THE FIRST END USER'S SITE ANY PRODUCTS

CLAIMED TO BE DEFECTIVE BEFORE ISSUING A RETURN MATERIAL AUTHORIZATION. SHOULD SUCH INSPECTION REVEAL, IN TLV'S REASONABLE DISCRETION, THAT THE CLAIMED DEFECT IS NOT COVERED BY THIS WARRANTY, THE PARTY ASSERTING THIS WARRANTY SHALL PAY TLV FOR THE TIME AND EXPENSES RELATED TO SUCH ON-SITE INSPECTION.

Exclusion Of Consequential And Incidental Damages

IT IS SPECIFICALLY ACKNOWLEDGED THAT THIS WARRANTY, ANY OTHER EXPRESS WARRANTY NOT NEGATED HEREBY, AND ANY IMPLIED WARRANTY NOT NEGATED HEREBY, INCLUDING THE IMPLIED WARRANTIES OF MERCHANTABILITY AND FITNESS FOR A PARTICULAR PURPOSE, DO NOT COVER, AND NEITHER TLV, TII NOR TLVJ WILL IN ANY EVENT BE LIABLE FOR, INCIDENTAL OR CONSEQUENTIAL DAMAGES, INCLUDING, BUT NOT LIMITED TO LOST PROFITS, THE COST OF DISASSEMBLY AND SHIPMENT OF THE DEFECTIVE PRODUCT, INJURY TO OTHER PROPERTY, DAMAGE TO BUYER'S OR THE FIRST END USER'S PRODUCT, DAMAGE TO BUYER'S OR THE FIRST END USER'S PROCESSES, LOSS OF USE, OR OTHER COMMERCIAL LOSSES. WHERE, DUE TO OPERATION OF LAW, CONSEQUENTIAL AND INCIDENTAL DAMAGES UNDER THIS WARRANTY, UNDER ANY OTHER EXPRESS WARRANTY NOT NEGATED HEREBY OR UNDER ANY IMPLIED WARRANTY NOT NEGATED HEREBY (INCLUDING THE IMPLIED WARRANTIES OF MERCHANTABILITY AND FITNESS FOR A PARTICULAR PURPOSE) CANNOT BE EXCLUDED, SUCH DAMAGES ARE EXPRESSLY LIMITED IN AMOUNT TO THE PURCHASE PRICE OF THE DEFECTIVE PRODUCT. THIS EXCLUSION OF CONSEQUENTIAL AND INCIDENTAL DAMAGES, AND THE PROVISION OF THIS WARRANTY LIMITING REMEDIES HEREUNDER TO REPLACEMENT, ARE INDEPENDENT PROVISIONS, AND ANY DETERMINATION THAT THE LIMITATION OF REMEDIES FAILS OF ITS ESSENTIAL PURPOSE OR ANY OTHER DETERMINATION THAT EITHER OF THE ABOVE REMEDIES IS UNENFORCEABLE, SHALL NOT BE CONSTRUED TO MAKE THE OTHER PROVISIONS UNENFORCEABLE.

Exclusion Of Other Warranties

THIS WARRANTY IS IN LIEU OF ALL OTHER WARRANTIES, EXPRESS OR IMPLIED, AND ALL OTHER WARRANTIES, INCLUDING BUT NOT LIMITED TO THE IMPLIED WARRANTIES OF MERCHANTABILITY AND FITNESS FOR A PARTICULAR PURPOSE, ARE EXPRESSLY DISCLAIMED.

Severability

Any provision of this warranty which is invalid, prohibited or unenforceable in any jurisdiction shall, as to such jurisdiction, be ineffective to the extent of such invalidity, prohibition or unenforceability without invalidating the remaining provisions hereof, and any such invalidity, prohibition or unenforceability in any such jurisdiction shall not invalidate or render unenforceable such provision in any other jurisdiction.

TLV CORPORATION

13901 South Lakes Drive, Charlotte, NC 28273-6790, U.S.A.

Tel: [1]-704-597-9070

Fax: [1]-704-583-1610