



FREE FLOAT® STEAM TRAP

MODEL JH3S-X/JH3S-B

FREE FLOAT STEAM TRAP WITH THERMOSTATIC AIR VENTING

Benefits

A reliable and durable stainless steel steam trap for use on small-size process equipment. JH3S-B is also suitable for both superheated and high-pressure process equipment.

1. Self-modulating free float provides continuous, smooth, low-velocity condensate discharge as process loads vary.
2. Constant water seal and three-point seating design ensure a steam-tight seal, even under no-load conditions.
3. Only one moving part, the free float, prevents concentrated valve wear and provides long maintenance-free service life.
4. Up to 1740 psig hydraulic shock rating ensures excellent resistance of the float to water hammer.
5. **JH3S-X**: Thermostatic capsule (X-element) with "fail open" feature vents air automatically at close-to-steam temperature.
6. **JH3S-B**: Thermostatic bimetal air vent valve vents air automatically for rapid startup.
7. Built-in screen with large surface area ensures extended trouble-free operation.



Specifications

Model	JH3S-X			JH3S-B		
	Screwed	Socket Weld	Flanged	Screwed	Socket Weld	Flanged
Connection						
Size (in)	1/2, 3/4, 1		1/2, 3/4, 1	1/2, 3/4, 1		1/2, 3/4, 1
Orifice No.	2, 5, 10, 14, 22, 32			2, 5, 10, 14, 22, 32		
Maximum Operating Pressure (psig) PMO	30, 75, 150, 200, 315, 450			30, 75, 150, 200, 315, 450		
Maximum Differential Pressure (psi) ΔPMX	30, 75, 150, 200, 315, 450			30, 75, 150, 200, 315, 450		
Minimum Operating Pressure (psig)	Vacuum			1.5		
Maximum Operating Temperature (°F) TMO	464			662		
Maximum Allowable Pressure (psig) PMA	450			450		
Maximum Allowable Temperature (°F) TMA	662			662		
Type of Air Vent	X-element (11 °F subcooling)			Bimetal (vents air up to approx. 212 °F)		

Connections and sizes in bold are standard

No.	Description	Material	ASTM/AISI*	JIS
①	Body	Cast Stainless Steel	A351 Gr.CF8	—
②	Cover	Cast Stainless Steel	A351 Gr.CF8	—
③ ^F	Float	Stainless Steel	AISI316L	SUS316L
④ ^R	Orifice	—	—	—
⑤ ^{MR}	Orifice Gasket	Stainless Steel	AISI316L	SUS316L
⑥	Orifice Plug	Stainless Steel	A351 Gr.CF8	—
⑦ ^{MR}	Orifice Plug Gasket	Stainless Steel	AISI316L	SUS316L
⑧ ^{MR}	Cover Gasket	Graphite/Stainless Steel	- /AISI316L	- /SUS316L
⑨ ^R	Float Cover	Stainless Steel	AISI304	SUS304
⑩ ^R	Screen	Stainless Steel	AISI430	SUS430
⑪ ^R	Spring Clip	Stainless Steel	AISI304	SUS304
⑫ ^R	X-element Guide	Stainless Steel	AISI304	SUS304
⑬ ^R	Air Vent Valve Seat	Stainless Steel	AISI420F	SUS420F
⑭ ^R	X-element	Stainless Steel	—	—
⑮ ^R	Snap Ring	Stainless Steel	AISI304	SUS304
⑯ ^R	Air Vent Case	Cast Stainless Steel	A351 Gr.CF8	—
⑰ ^R	Bimetal Plate	Bimetal	—	—
⑱ ^R	Air Vent Screen	Stainless Steel	AISI304	SUS304
⑲ ^R	Air Vent Valve Seat	—	—	—
⑳ ^R	Air Vent Valve Plug	—	—	—
㉑ ^R	Snap Ring	Stainless Steel	AISI304	SUS304
㉒	Connector	Stainless Steel	AISI416	SUS416
㉓	Cover Bolt	Alloy Steel	AISI304	SUS304
㉔	Nameplate	Stainless Steel	AISI304	SUS304
㉕	Socket**/Flange**	Cast Stainless Steel	A351 Gr.CF8	—
㉖	Drain Plug Gasket***	Stainless Steel	AISI316L	SUS316L
㉗	Drain Plug***	Stainless Steel	AISI303	SUS303

* Equivalent ** Shown on reverse *** Option

Replacement kits available: (M) maintenance parts, (R) repair parts, (F) float



To avoid abnormal operation, accidents or serious injury, DO NOT use this product outside of the specification range. Local regulations may restrict the use of this product to below the conditions quoted.

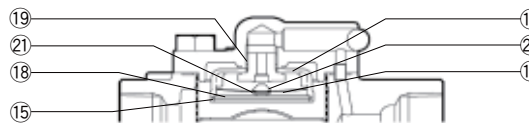

JH3S-B

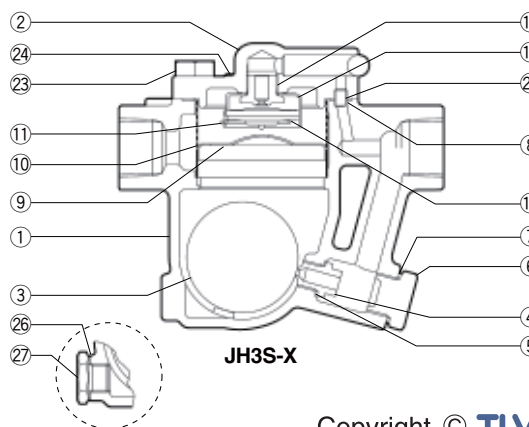

JH3S-X

Dimensions

● **JH3S-X/JH3S-B** Screwed

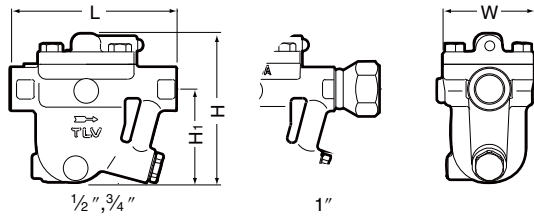

JH3S-X/JH3S-B Screwed* (in)

Size	L	H	H ₁	W	Weight (lb)
1/2	5 11/16	5 1/16	3 3/4	3 3/8	5.9
3/4					6.2
1	8				

* NPT, other standards available

● **JH3S-X/JH3S-B** Socket Weld

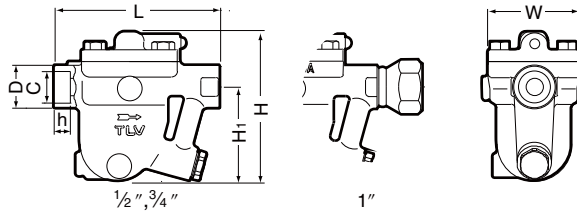

JH3S-X/JH3S-B Socket Weld* (in)

Size	L	H	H ₁	W	φD	φC	h	Weight (lb)
1/2	5 11/16	5 1/16	3 3/4	3 3/8	1 7/16	0.855	1/2	5.9
3/4					1 3/4	1.065	9/16	6.2
1	8							

* ASME B16.11-2005, other standards available

● **JH3S-X/JH3S-B** Flanged

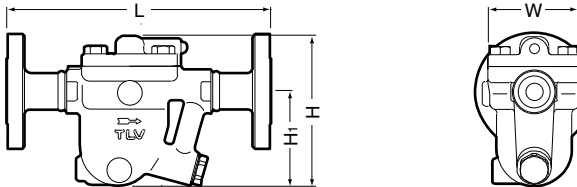

JH3S-X/JH3S-B Flanged (in)

Size	L			H	H ₁	W	Weight* (lb)
	Connects to ASME Class						
	150RF	300RF	600RF				
1/2	8 1/4	8 1/4	8 11/16	5 1/16	3 3/4	3 3/8	9.5
3/4	9 1/16	9 1/16	9 1/16				11
1	9 13/16	9 13/16	9 13/16				13

Other standards available, but length and weight may vary
* Weight is for Class 600 RF

Flange classes in bold are standard

Discharge Capacity

● **JH3S-X**

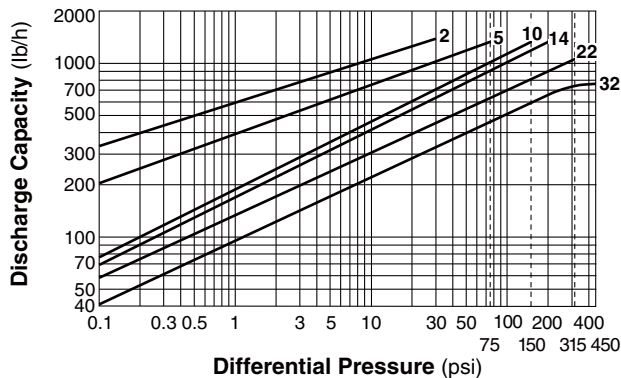

● **JH3S-B**

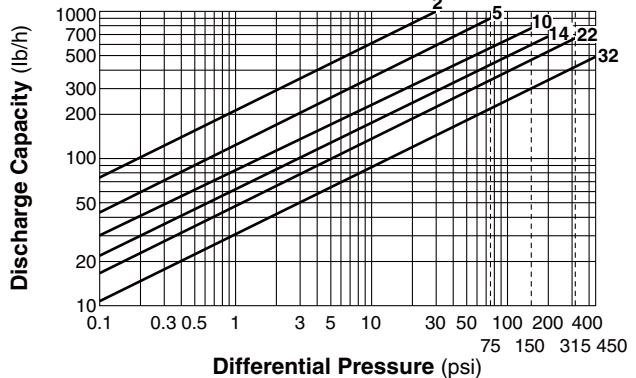

- Line numbers within the graph are orifice numbers.
- Differential pressure is the difference between the inlet and outlet pressure of the trap.
- Capacities are based on continuous discharge of condensate 11 °F below saturated steam temperature.
- Recommended safety factor: at least 1.5



DO NOT use this product under conditions that exceed maximum differential pressure, as condensate backup will occur!



DO NOT DISASSEMBLE OR REMOVE THIS PRODUCT WHILE IT IS UNDER PRESSURE. Allow internal pressure of this product to equal atmospheric pressure and its surface to cool to room temperature before disassembling or removing. Failure to do so could cause burns or other injury. READ INSTRUCTION MANUAL CAREFULLY.

TLV CORPORATION

13901 South Lakes Drive, Charlotte, NC 28273-6790
Tel: 704-597-9070 Fax: 704-583-1610
E-mail: tlv@tlvengineering.com <https://www.tlv.com>
For Technical Service 1-800 "TLV TRAP"



Manufacturer
TLV CO., LTD.
Kakogawa, Japan
is approved by LRQA Ltd. to ISO 9001/14001

