



Instruction Manual

Cyclone Separator **DC3-L**

Contents

Introduction	1
Safety Considerations	2
Specifications	4
Configuration	4
Installation	5
Maintenance	6
Disassembly/Reassembly	6
Troubleshooting	8
TLV EXPRESS LIMITED WARRANTY	9
Service	11

Introduction

Thank you for purchasing the TLV cyclone separator.

This product has been thoroughly inspected before being shipped from the factory. When the product is delivered, before doing anything else, check the specifications and external appearance to make sure nothing is out of the ordinary. Also be sure to read this manual carefully before use and follow the instructions to be sure of using the product properly.

This cyclone separator uses centrifugal force to separate condensate from air or steam in piping lines.





If detailed instructions for special order specifications or options not contained in this manual are required, please contact TLV for full details.



This instruction manual is intended for use with the model(s) listed on the front cover. It is necessary not only for installation but for subsequent maintenance, disassembly/reassembly and troubleshooting. Please keep it in a safe place for future reference.

Safety Considerations

- Read this section carefully before use and be sure to follow the instructions.
- Installation, inspection, maintenance, repairs, disassembly, adjustment and valve opening/closing should be carried out only by trained maintenance personnel.
- The precautions listed in this manual are designed to ensure safety and prevent equipment damage and personal injury. For situations that may occur as a result of erroneous handling, three different types of cautionary items are used to indicate the degree of urgency and the scale of potential damage and danger: DANGER, WARNING and CAUTION.
- The three types of cautionary items above are very important for safety: be sure to observe all of them as they relate to installation, use, maintenance, and repair. Furthermore, TLV accepts no responsibility for any accidents or damage occurring as a result of failure to observe these precautions.

Symbols

	Indicates a DANGER, WARNING or CAUTION item.
	Indicates an urgent situation which poses a threat of death or serious injury
	Indicates that there is a potential threat of death or serious injury
	Indicates that there is a possibility of injury or equipment / product damage

	<p>DO NOT use for toxic, flammable or otherwise hazardous fluids.</p> <p>This product is a separator for steam or air that separates and discharges condensate from steam or air piping systems. Use only for steam, air and/or condensate. This product is for intended use only. Improper use may result in such hazards as damage to the product or malfunctions that may lead to serious accidents.</p>
	<p>Install properly and DO NOT use this product outside the recommended operating pressure, temperature and other specification ranges.</p> <p>Improper use may result in such hazards as damage to the product or malfunctions that may lead to serious accidents. Local regulations may restrict the use of this product to below the conditions quoted.</p> <p>Use hoisting equipment for heavy objects (weighing approximately 20 kg (44 lb) or more).</p> <p>Failure to do so may result in back strain or other injury if the object should fall.</p>

Continued on the next page

 CAUTION	<p>Take measures to prevent people from coming into direct contact with product outlets. Failure to do so may result in burns or other injury from the discharge of fluids.</p>
	<p>When disassembling or removing the product, wait until the internal pressure equals atmospheric pressure and the surface of the product has cooled to room temperature. Disassembling or removing the product when it is hot or under pressure may lead to discharge of fluids, causing burns, other injuries or damage.</p>
	<p>Be sure to use only the recommended components when repairing the product, and NEVER attempt to modify the product in any way. Failure to observe these precautions may result in damage to the product and burns or other injury due to malfunction or the discharge of fluids.</p>
	<p>Do not use excessive force when connecting threaded pipes to the product. Over-tightening may cause breakage leading to fluid discharge, which may cause burns or other injury.</p>
	<p>Use only under conditions in which no freeze-up will occur. Freezing may damage the product, leading to fluid discharge, which may cause burns or other injury.</p>
	<p>Use only under conditions in which no water hammer will occur. The impact of water hammer may damage the product, leading to fluid discharge, which may cause burns or other injury.</p>

Specifications



WARNING

DO NOT use for toxic, flammable or otherwise hazardous fluids. This product is a separator for steam or air that separates and discharges condensate from steam or air piping systems. Use only for steam, air and/or condensate. This product is for intended use only. Improper use may result in such hazards as damage to the product or malfunctions that may lead to serious accidents.



CAUTION

Install properly and DO NOT use this product outside the recommended operating pressure, temperature and other specification ranges. Improper use may result in such hazards as damage to the product or malfunctions which may lead to serious accidents. Local regulations may restrict the use of this product to below the conditions quoted.



CAUTION

Use only under conditions in which no freeze-up will occur. Freezing may damage the product, leading to fluid discharge, which may cause burns or other injury.

Refer to the product nameplate for detailed specifications.

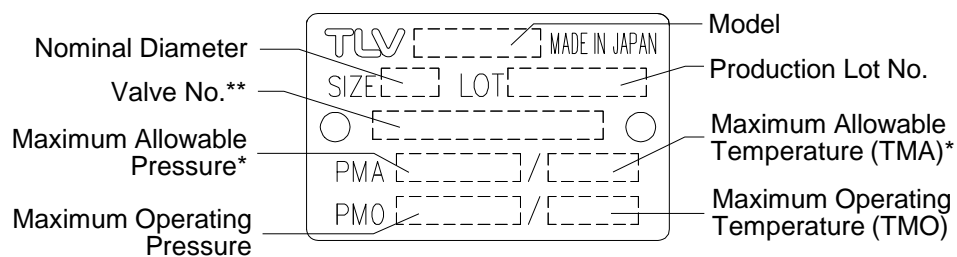

*Maximum allowable pressure (PMA) and maximum allowable temperature (TMA) are PRESSURE SHELL DESIGN CONDITIONS, **NOT** OPERATING CONDITIONS.

**Valve No. is displayed for products with options. This item is omitted from the nameplate when there are no options.

Configuration

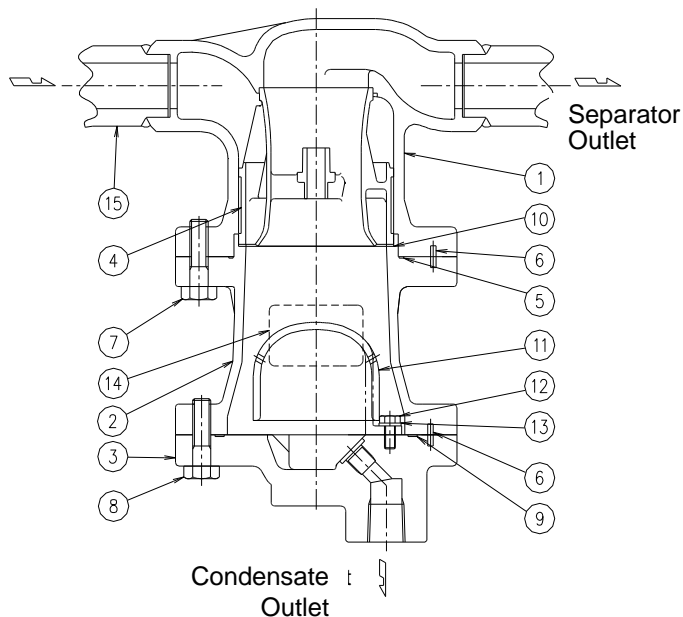

No.	Name
1	Body
2	Separator Body
3	Cover
4	Separator
5	Body Gasket
6	Guide Pin
7	Body Bolt
8	Cover Bolt
9	Cover Gasket
10	Wave Spring
11	Float Cover
12	Float Cover Bolt
13	Spring Washer
14	Nameplate
15	Flange (15 – 25 mm (1/2 – 1 in))

Installation



WARNING

DO NOT use for toxic, flammable or otherwise hazardous fluids. This product is a separator for steam or air that separates and discharges condensate from steam or air piping systems. Use only for steam, air and/or condensate. This product is for intended use only. Improper use may result in such hazards as damage to the product or malfunctions that may lead to serious accidents.



CAUTION

Install properly and DO NOT use this product outside the recommended operating pressure, temperature and other specification ranges. Improper use may result in such hazards as damage to the product or malfunctions which may lead to serious accidents. Local regulations may restrict the use of this product to below the conditions quoted.



CAUTION

Use hoisting equipment for heavy objects (weighing approximately 20 kg (44 lb) or more). Failure to do so may result in back strain or other injury if the object should fall.



CAUTION

Take measures to prevent people from coming into direct contact with product outlets. Failure to do so may result in burns or other injury from the discharge of fluids.



CAUTION

Do not use excessive force when connecting threaded pipes to the product. Over-tightening may cause breakage leading to fluid discharge, which may cause burns or other injury.

Installation, inspection, maintenance, repairs, disassembly, adjustment and valve opening/closing should be carried out only by trained maintenance personnel.

1. Before installation, be sure to remove all protective seals.
2. Before installing the product, blow out the inlet piping to remove any piping scraps, dirt and oil. Close the inlet valve after blowdown.
3. Install the product at the point on the piping where the separation of condensate will have the greatest effect on efficiency. For example, on a steam or air main or branch at the inlet of equipment requiring high-quality dry steam or air.
4. Install the product so the arrow on the product is pointing in the direction of flow.
5. The product should be inclined no more than 10° horizontally and front-to-back.
6. Install an air trap or steam trap at the condensate outlet. Use of the TLV free float type trap is advised.
7. To facilitate inspection and maintenance, install a union at the condensate outlet and ensure that there is sufficient space for maintenance.
8. Open the inlet valve and outlet valves and check to make sure that the product functions properly.

If there is a problem, determine the cause using the “Troubleshooting” section in this manual.

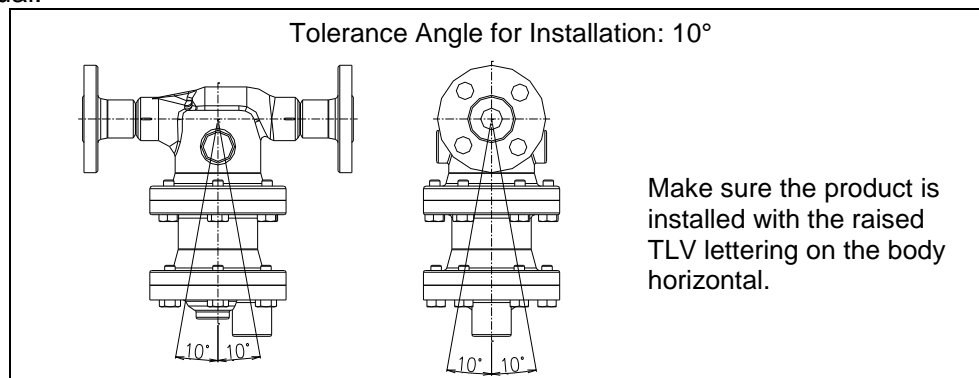

Maintenance

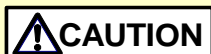

Take measures to prevent people from coming into direct contact with product outlets. Failure to do so may result in burns or other injury from the discharge of fluids.



Be sure to use only the recommended components when repairing the product, and NEVER attempt to modify the product in any way. Failure to observe these precautions may result in damage to the product or burns or other injury due to malfunction or the discharge of fluids.

Parts Inspection

When parts have been removed, or during periodic inspections, use the following table to inspect the parts and replace any that are found to be defective.

Procedure
Gaskets: Check for warping or scratches
Body Interior: Check for build-up

Disassembly/Reassembly

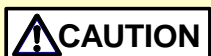

Use hoisting equipment for heavy objects (weighing approximately 20 kg (44 lb) or more). Failure to do so may result in back strain or other injury if the object should fall.



When disassembling or removing the product, wait until the internal pressure equals atmospheric pressure and the surface of the product has cooled to room temperature. Disassembling or removing the product when it is hot or under pressure may lead to discharge of fluids, causing burns, other injuries or damage.

Use the following procedures to remove components. Use the same procedures in reverse to reassemble. (Installation, inspection, maintenance, repairs, disassembly, adjustment and valve opening/closing should be carried out only by trained maintenance personnel.)

Detaching/Reattaching the Cover

Part	During Disassembly	During Reassembly
Cover Bolt	Remove with a socket wrench	Consult the table of tightening torques and tighten to the proper torque
Cover	Remove the cover by pulling it down, being careful not to scratch the seating surface	Make sure there are no pieces of the old gasket left on the sealing surfaces of the separator body and cover, align the guide pin on the cover with the guide pin hole on the separator body and reattach
Cover Gasket	Remove the gasket and clean sealing surfaces	Replace with a new gasket

Detaching/Reattaching Parts Inside the Cover

Float Cover Bolt (Spring Washer)	Remove with a socket wrench	Consult the table of tightening torques and tighten to the proper torque
Float Cover	Remove by lifting up and off	Place it into position

Separating/Reattaching Body and Separator Body

Part	During Disassembly	During Reassembly
Body Bolt	Remove with a socket wrench	Consult the table of tightening torques and tighten to the proper torque
Separator Body	Pull down and out from the body, being careful not to let the separator fall as it comes out with the separator body	Make sure there are no pieces of the old gasket left on the sealing surfaces of the separator body and body, align the guide pin on the separator body with the guide pin hole on the body and reattach
Separator	Remove when detaching the separator body	Insert it into the groove in the separator body
Wave Spring	Remove with the separator	Insert it into the groove
Body Gasket	Remove the gasket and clean sealing surfaces	Replace with a new gasket

Table of Tightening Torques

Part	Size		Torque		Distance Across Flats	
	mm	(in)	N·m	(lbf·ft)	mm	(in)
Body Bolt	15 – 40	($\frac{1}{2}$ – $1\frac{1}{2}$)	60	(44)	17	($\frac{21}{32}$)
	50	(2)	70	(51)	19	($\frac{3}{4}$)
Cover Bolt	15 – 40	($\frac{1}{2}$ – $1\frac{1}{2}$)	60	(44)	17	($\frac{21}{32}$)
	50	(2)	70	(51)	19	($\frac{3}{4}$)
Float Cover Bolt	15 – 40	($\frac{1}{2}$ – $1\frac{1}{2}$)	10	(7)	10	($\frac{3}{8}$)
	50	(2)	20	(15)	13	($\frac{1}{2}$)

NOTE: -Coat all threaded portions with anti-seize. (1 N·m \approx 10 kg·cm)
 -If drawings or other special documentation were supplied for the product, any torque given there takes precedence over values shown here.

Exploded View

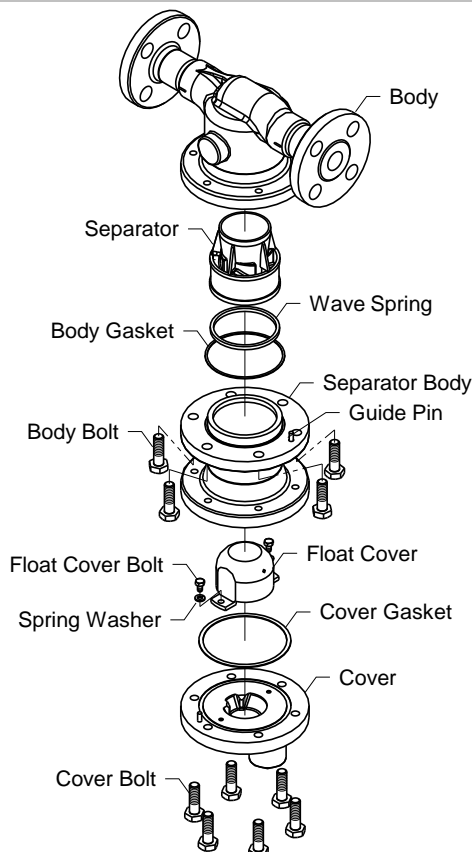

Troubleshooting



When disassembling or removing the product, wait until the internal pressure equals atmospheric pressure and the surface of the product has cooled to room temperature. Disassembling or removing the product when it is hot or under pressure may lead to discharge of fluids, causing burns, other injuries or damage.

When the product fails to operate properly, use the following table to locate the cause and remedy.

Problem	Cause	Remedy
Steam or air is leaking from sealing surfaces	Gasket deterioration or damage	Replace with new gasket(s)
	Improper tightening torques were used	Tighten to the proper torque
Water is mixed in with the steam or air from the separator outlet	Steam/air flow velocity is too high	Take steps necessary to lower the steam/air flow velocity
	Improper installation	Correct the installation

TLV EXPRESS LIMITED WARRANTY

Subject to the limitations set forth below, TLV CO., LTD., a Japanese corporation (“**TLV**”), warrants that products which are sold by it, TLV International Inc. (“**TII**”) or one of its group companies excluding TLV Corporation (a corporation of the United States of America), (hereinafter the “**Products**”) are designed and manufactured by TLV, conform to the specifications published by TLV for the corresponding part numbers (the “**Specifications**”) and are free from defective workmanship and materials. The party from whom the Products were purchased shall be known hereinafter as the “**Seller**”. With regard to products or components manufactured by unrelated third parties (the “**Components**”), TLV provides no warranty other than the warranty from the third party manufacturer(s), if any.

Exceptions to Warranty

This warranty does not cover defects or failures caused by:

1. improper shipping, installation, use, handling, etc., by persons other than TLV, TII or TLV group company personnel, or service representatives authorized by TLV; or
2. dirt, scale or rust, etc.; or
3. improper disassembly and reassembly, or inadequate inspection and maintenance by persons other than TLV or TLV group company personnel, or service representatives authorized by TLV; or
4. disasters or forces of nature or Acts of God; or
5. abuse, abnormal use, accidents or any other cause beyond the control of TLV, TII or TLV group companies; or
6. improper storage, maintenance or repair; or
7. operation of the Products not in accordance with instructions issued with the Products or with accepted industry practices; or
8. use for a purpose or in a manner for which the Products were not intended; or
9. use of the Products in a manner inconsistent with the Specifications; or
10. use of the Products with Hazardous Fluids (fluids other than steam, air, water, nitrogen, carbon dioxide and inert gases (helium, neon, argon, krypton, xenon and radon)); or
11. failure to follow the instructions contained in the TLV Instruction Manual for the Product.

Duration of Warranty

This warranty is effective for a period of one (1) year after delivery of Products to the first end user. Notwithstanding the foregoing, asserting a claim under this warranty must be brought within three (3) years after the date of delivery to the initial buyer if not sold initially to the first end user.

ANY IMPLIED WARRANTIES NOT NEGATED HEREBY WHICH MAY ARISE BY OPERATION OF LAW, INCLUDING THE IMPLIED WARRANTIES OF MERCHANTABILITY AND FITNESS FOR A PARTICULAR PURPOSE AND ANY EXPRESS WARRANTIES NOT NEGATED HEREBY, ARE GIVEN SOLELY TO THE INITIAL BUYER AND ARE LIMITED IN DURATION TO ONE (1) YEAR FROM THE DATE OF SHIPMENT BY THE SELLER.

Exclusive Remedy

THE EXCLUSIVE REMEDY UNDER THIS WARRANTY, UNDER ANY EXPRESS WARRANTY OR UNDER ANY IMPLIED WARRANTIES NOT NEGATED HEREBY (INCLUDING THE IMPLIED WARRANTIES OF MERCHANTABILITY AND FITNESS FOR A PARTICULAR PURPOSE), IS **REPLACEMENT**; PROVIDED: (a) THE CLAIMED DEFECT IS

REPORTED TO THE SELLER IN WRITING WITHIN THE WARRANTY PERIOD, INCLUDING A DETAILED WRITTEN DESCRIPTION OF THE CLAIMED DEFECT AND HOW AND WHEN THE CLAIMED DEFECTIVE PRODUCT WAS USED; AND (b) THE CLAIMED DEFECTIVE PRODUCT AND A COPY OF THE PURCHASE INVOICE IS RETURNED TO THE SELLER, FREIGHT AND TRANSPORTATION COSTS PREPAID, UNDER A RETURN MATERIAL AUTHORIZATION AND TRACKING NUMBER ISSUED BY THE SELLER. ALL LABOR COSTS, SHIPPING COSTS, AND TRANSPORTATION COSTS ASSOCIATED WITH THE RETURN OR REPLACEMENT OF THE CLAIMED DEFECTIVE PRODUCT ARE SOLELY THE RESPONSIBILITY OF BUYER OR THE FIRST END USER. THE SELLER RESERVES THE RIGHT TO INSPECT ON THE FIRST END USER'S SITE ANY PRODUCTS CLAIMED TO BE DEFECTIVE BEFORE ISSUING A RETURN MATERIAL AUTHORIZATION. SHOULD SUCH INSPECTION REVEAL, IN THE SELLER'S REASONABLE DISCRETION, THAT THE CLAIMED DEFECT IS NOT COVERED BY THIS WARRANTY, THE PARTY ASSERTING THIS WARRANTY SHALL PAY THE SELLER FOR THE TIME AND EXPENSES RELATED TO SUCH ON-SITE INSPECTION.

Exclusion of Consequential and Incidental Damages

IT IS SPECIFICALLY ACKNOWLEDGED THAT THIS WARRANTY, ANY OTHER EXPRESS WARRANTY NOT NEGATED HEREBY, AND ANY IMPLIED WARRANTY NOT NEGATED HEREBY, INCLUDING THE IMPLIED WARRANTIES OF MERCHANTABILITY AND FITNESS FOR A PARTICULAR PURPOSE, DO NOT COVER, AND NEITHER TLV, TII NOR ITS TLV GROUP COMPANIES WILL IN ANY EVENT BE LIABLE FOR, INCIDENTAL OR CONSEQUENTIAL DAMAGES, INCLUDING, BUT NOT LIMITED TO LOST PROFITS, THE COST OF DISASSEMBLY AND SHIPMENT OF THE DEFECTIVE PRODUCT, INJURY TO OTHER PROPERTY, DAMAGE TO BUYER'S OR THE FIRST END USER'S PRODUCT, DAMAGE TO BUYER'S OR THE FIRST END USER'S PROCESSES, LOSS OF USE, OR OTHER COMMERCIAL LOSSES. WHERE, DUE TO OPERATION OF LAW, CONSEQUENTIAL AND INCIDENTAL DAMAGES UNDER THIS WARRANTY, UNDER ANY OTHER EXPRESS WARRANTY NOT NEGATED HEREBY OR UNDER ANY IMPLIED WARRANTY NOT NEGATED HEREBY (INCLUDING THE IMPLIED WARRANTIES OF MERCHANTABILITY AND FITNESS FOR A PARTICULAR PURPOSE) CANNOT BE EXCLUDED, SUCH DAMAGES ARE EXPRESSLY LIMITED IN AMOUNT TO THE PURCHASE PRICE OF THE DEFECTIVE PRODUCT. THIS EXCLUSION OF CONSEQUENTIAL AND INCIDENTAL DAMAGES, AND THE PROVISION OF THIS WARRANTY LIMITING REMEDIES HEREUNDER TO REPLACEMENT, ARE INDEPENDENT PROVISIONS, AND ANY DETERMINATION THAT THE LIMITATION OF REMEDIES FAILS OF ITS ESSENTIAL PURPOSE OR ANY OTHER DETERMINATION THAT EITHER OF THE ABOVE REMEDIES IS UNENFORCEABLE, SHALL NOT BE CONSTRUED TO MAKE THE OTHER PROVISIONS UNENFORCEABLE.

Exclusion of Other Warranties

THIS WARRANTY IS IN LIEU OF ALL OTHER WARRANTIES, EXPRESS OR IMPLIED, AND ALL OTHER WARRANTIES, INCLUDING BUT NOT LIMITED TO THE IMPLIED WARRANTIES OF MERCHANTABILITY AND FITNESS FOR A PARTICULAR PURPOSE, ARE EXPRESSLY DISCLAIMED.

Severability

Any provision of this warranty which is invalid, prohibited or unenforceable in any jurisdiction shall, as to such jurisdiction, be ineffective to the extent of such invalidity, prohibition or unenforceability without invalidating the remaining provisions hereof, and any such invalidity, prohibition or unenforceability in any such jurisdiction shall not invalidate or render unenforceable such provision in any other jurisdiction.

Service

For Service or Technical Assistance: Contact your TLV representative or your regional TLV office.

In Europe:

TLV EURO ENGINEERING GmbH

Daimler-Benz-Straße 16-18, 74915 Waibstadt, **Germany**

Tel: [49]-(0)7263-9150-0
Fax: [49]-(0)7263-9150-50

TLV EURO ENGINEERING UK LTD.

Units 7 & 8, Furlong Business Park, Bishops Cleeve, Gloucestershire GL52 8TW, **U.K.**

Tel: [44]-(0)1242-227223
Fax: [44]-(0)1242-223077

TLV EURO ENGINEERING FRANCE SARL

Parc d'Ariane 2, bât. C, 290 rue Ferdinand Perrier, 69800 Saint Priest, **France**

Tel: 33-(0)4-72482222
Fax: [33]-(0)4-72482220

In North America:

TLV CORPORATION

13901 South Lakes Drive, Charlotte, NC 28273-6790, **U.S.A.**

Tel: [1]-704-597-9070
Fax: [1]-704-583-1610

In Mexico and Latin America:

TLV ENGINEERING S. A. DE C. V.

Av. Jesús del Monte 39-B-1001, Col. Hda. de las Palmas, Huixquilucan, Edo. de México, 52763, **Mexico**

Tel: [52]-55-5359-7949
Fax: [52]-55-5359-7585

In Oceania:

TLV PTY LIMITED

Unit 8, 137-145 Rooks Road, Nunawading, Victoria 3131, **Australia**

Tel: [61]-(0)3-9873 5610
Fax: [61]-(0)3-9873 5010

In East Asia:

TLV PTE LTD

36 Kaki Bukit Place, #02-01/02, **Singapore** 416214

Tel: [65]-6747 4600
Fax: [65]-6742 0345

TLV SHANGHAI CO., LTD.

Room 5406, No. 103 Cao Bao Road, Shanghai, **China** 200233

Tel: [86]-(0)21-6482-8622
Fax: [86]-(0)21-6482-8623

TLV ENGINEERING SDN. BHD.

No.16, Jalan MJ14, Taman Industri Meranti Jaya, 47120 Puchong, Selangor, **Malaysia**

Tel: [60]-3-8065-2928
Fax: [60]-3-8065-2923

TLV PRIVATE LIMITED

252/94 (K-L) 17th Floor, Muang Thai-Phatra Complex Tower B, Rachadaphisek Road, Huaykwang, Bangkok 10310, **Thailand**

Tel: [66]-2-693-3799
Fax: [66]-2-693-3979

TLV INC.

#302-1 Bundang Technopark B, 723 Pangyo-ro, Bundang, Seongnam, Gyeonggi, 13511, **Korea**

Tel: [82]-(0)31-726-2105
Fax: [82]-(0)31-726-2195

In the Middle East:

TLV ENGINEERING FZCO

Building 2W, No. M002, PO Box 371684, Dubai Airport Free Zone, Dubai, **UAE**

Email: sales-me@tlv.co.jp

In Other Countries:

TLV INTERNATIONAL, INC.

881 Nagasuna, Noguchi, Kakogawa, Hyogo 675-8511, **Japan**

Tel: [81]-(0)79-427-1818
Fax: [81]-(0)79-425-1167

Manufacturer:

TLV CO., LTD.

881 Nagasuna, Noguchi, Kakogawa, Hyogo 675-8511, **Japan**

Tel: [81]-(0)79-422-1122
Fax: [81]-(0)79-422-0112