



Manufacturer

TLV CO., LTD.

Kakogawa, Japan

is approved by LRQA Ltd. to ISO 9001/14001



Instruction Manual

Free Float Steam Trap with X-element **JH7.5R-X**

Copyright © 2020 by TLV CO., LTD.

All rights reserved

Contents

Introduction	1
Safety Considerations	2
Checking the Piping	4
Operation	5
Specifications	6
Configuration	6
Installation	7
Maintenance.....	8
Disassembly/Reassembly	9
Instructions for Plug/Holder Disassembly and Reassembly ...	12
Troubleshooting	13
Product Warranty	14
Options.....	15

Introduction

Thank you for purchasing the TLV free float steam trap.

This product has been thoroughly inspected before being shipped from the factory. When the product is delivered, before doing anything else, check the specifications and external appearance to make sure nothing is out of the ordinary. Also be sure to read this manual carefully before use and follow the instructions to be sure of using the product properly.

This free float steam trap employs a hinge-less and lever-less free float to rapidly, automatically and continuously discharge the inflowing condensate that is continuously generated inside the equipment, thus preventing the accumulation of condensate and thereby improving the heat transfer efficiency of the equipment.

This steam trap is also of a revolutionary design featuring an integral air vent that employs a high-performance X-element. The X-element is very sensitive to changes in temperature, and responds with great accuracy. As a result, air and the large quantities of condensate created immediately after the start-up of operation are quickly discharged, thereby greatly reducing start-up time and also proving useful in valve operation (bypass blowdown) labor-saving. The X-element is also sensitive to hot air during operation, responding quickly and thus preventing the occurrence of air binding.

These features make this free float steam trap ideally suited for use on process systems and equipment (steam-using equipment), and it is especially well-suited for removing condensate from equipment used for batch operations, which often experience entrained air during operation.





If detailed instructions for special order specifications or options not contained in this manual are required, please contact TLV for full details.



This instruction manual is intended for use with the model(s) listed on the front cover. It is necessary not only for installation but for subsequent maintenance, disassembly/reassembly and troubleshooting. Please keep it in a safe place for future reference.

Safety Considerations

- Read this section carefully before use and be sure to follow the instructions.
- Installation, inspection, maintenance, repairs, disassembly, adjustment and valve opening/closing should be carried out only by trained maintenance personnel.
- The precautions listed in this manual are designed to ensure safety and prevent equipment damage and personal injury. For situations that may occur as a result of erroneous handling, three different types of cautionary items are used to indicate the degree of urgency and the scale of potential damage and danger: DANGER, WARNING and CAUTION.
- The three types of cautionary items above are very important for safety: be sure to observe all of them as they relate to installation, use, maintenance, and repair. Furthermore, TLV accepts no responsibility for any accidents or damage occurring as a result of failure to observe these precautions.

Symbols

	Indicates a DANGER, WARNING or CAUTION item.
	Indicates an urgent situation which poses a threat of death or serious injury
	Indicates that there is a potential threat of death or serious injury
	Indicates that there is a possibility of injury or equipment/product damage

	NEVER apply direct heat to the float. The float may explode due to increased internal pressure, causing accidents leading to serious injury or damage to property and equipment.
	Install properly and DO NOT use this product outside the recommended operating pressure, temperature and other specification ranges. Improper use may result in such hazards as damage to the product or malfunctions that may lead to serious accidents. Local regulations may restrict the use of this product to below the conditions quoted.
	DO NOT use this product in excess of the maximum operating pressure differential. Such use could make discharge impossible (blocked).
	Use hoisting equipment for heavy objects (weighing approximately 20 kg (44 lb) or more). Failure to do so may result in back strain or other injury if the object should fall.
	Take measures to prevent people from coming into direct contact with product outlets. Failure to do so may result in burns or other injury from the discharge of fluids.

Continued on the next page

 CAUTION	<p>When disassembling or removing the product, wait until the internal pressure equals atmospheric pressure and the surface of the product has cooled to room temperature. Disassembling or removing the product when it is hot or under pressure may lead to discharge of fluids, causing burns, other injuries or damage.</p>
	<p>Be sure to use only the recommended components when repairing the product, and NEVER attempt to modify the product in any way. Failure to observe these precautions may result in damage to the product and burns or other injury due to malfunction or the discharge of fluids.</p>
	<p>Use only under conditions in which no freeze-up will occur. Freezing may damage the product, leading to fluid discharge, which may cause burns or other injury.</p>
	<p>Use only under conditions in which no water hammer will occur. The impact of water hammer may damage the product, leading to fluid discharge, which may cause burns or other injury.</p>



Checking the Piping



Use only under conditions in which no water hammer will occur. The impact of water hammer may damage the product, leading to fluid discharge, which may cause burns or other injury.

Check to make sure that the pipes to be connected to the product have been installed properly.

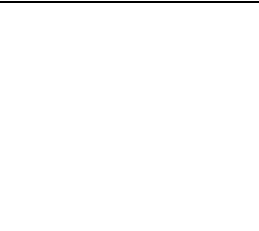
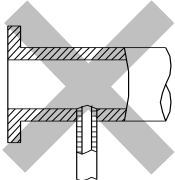
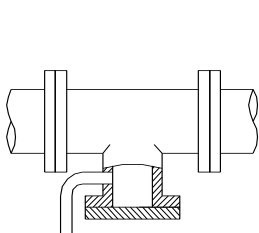
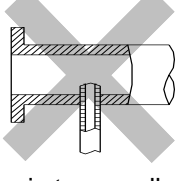
1. Is the pipe diameter suitable?
2. Is the piping where the trap is to be installed horizontal?
3. Has sufficient space been secured for maintenance?
4. Have isolation valves been installed at the inlet and outlet? If the outlet is subject to back pressure, has a check valve (TLV-CK) been installed?
5. Is the inlet pipe as short as possible, with as few bends as possible, and installed so the liquid will flow naturally down into the trap?
6. Has the piping work been done correctly, as shown in the figures below?

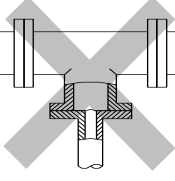
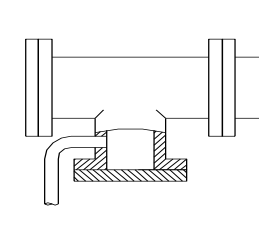
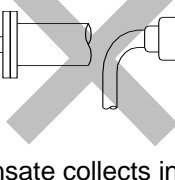
Requirement	Correct	Incorrect
Install catchpot with the proper diameter.		 Diameter is too small.
Make sure the flow of condensate is not obstructed.		 Diameter is too small and inlet protrudes into pipe interior.
To prevent rust and scale from flowing into the trap, the inlet pipe should be connected 25 – 50 mm (1 – 2 in) above the base of the T-pipe.		 Rust and scale flow into the trap with the condensate.
When installing on the blind end, make sure the flow of condensate is not obstructed.		 Condensate collects in the pipe.

Operation

Principles of air and condensate discharge:

1. Start-up Air and Cold Condensate Discharge

At start-up, before steam is supplied, the trap is cold so the X-element is contracted and the air vent valve (A) is open. This allows for the rapid discharge of air through the air vent valve (A) and cold condensate through the orifice (B), when steam is first supplied to the system.

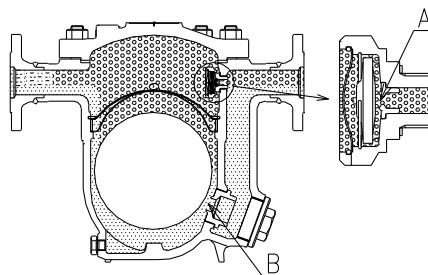

2. Condensate Discharge

After the discharge of initial air and cold condensate, the heat of the inflowing steam and condensate causes the X-element to expand, closing the air vent valve (A). The rising condensate level causes the float to rise due to buoyancy, opening the orifice (B) and allowing condensate to be discharged.

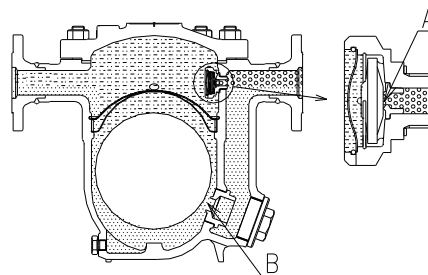

3. Hot Air Discharge

Should hot air flow into the trap with the steam during normal operation, the temperature of the X-element drops, causing it to momentarily contract and open the air vent valve (A), which allows for the rapid discharge of the air. After the air is discharged and steam contacts the X-element, the temperature will increase causing the air vent valve (A) to close.

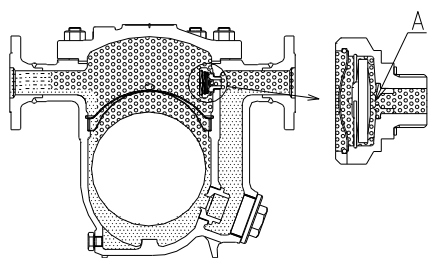

4. Discharge of Large Quantities of Condensate

Increases in the condensate inflow rate cause the condensate level in the trap to rise. The float consequently rises and enlarges the opening of the orifice (B), allowing more condensate to be discharged. If condensate flows in at a faster rate than it discharges through the orifice (B), the temperature of the X-element drops, causing it to momentarily contract and open the air vent valve (A), which allows for the rapid discharge of the condensate through both (A) and (B). In this manner, continuous condensate discharge occurs while the opening size of the orifice varies depending on the condensate flow rate.

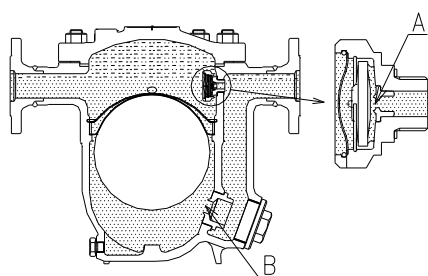

5. Closed Position

When the condensate flow rate decreases, the X-element expands due to the heat of the steam, closing the air vent valve (A). In addition, the float falls as condensate is discharged, closing off the orifice (B). A water seal is maintained at all times over the orifice (B) to prevent steam loss.

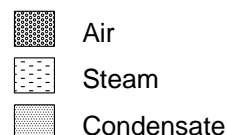
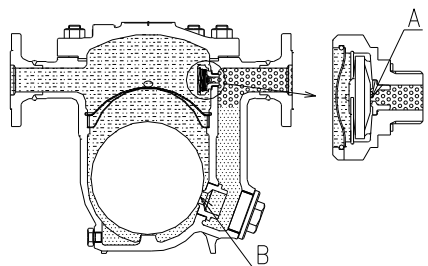

Specifications



Install properly and **DO NOT** use this product outside the recommended operating pressure, temperature and other specification ranges. Improper use may result in such hazards as damage to the product or malfunctions which may lead to serious accidents. Local regulations may restrict the use of this product to below the conditions quoted.



DO NOT use this product in excess of the maximum operating pressure differential; such use could make discharge impossible (blocked).



Use only under conditions in which no freeze-up will occur. Freezing may damage the product, leading to fluid discharge, which may cause burns or other injury.

Refer to the product nameplate for detailed specifications.

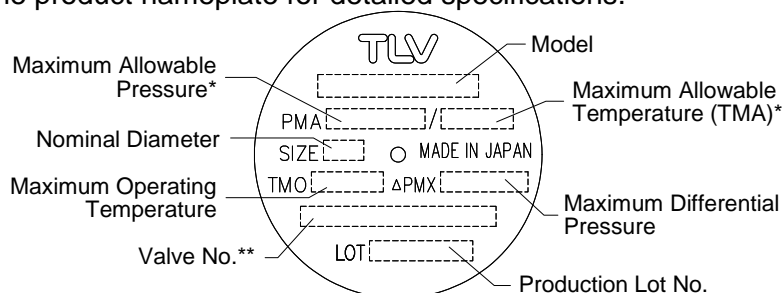

* Maximum allowable pressure (PMA) and maximum allowable temperature (TMA) are **PRESSURE SHELL DESIGN CONDITIONS, NOT OPERATING CONDITIONS.**

** Valve No. is displayed for products with options. This item is omitted from the nameplate when there are no options.

Configuration

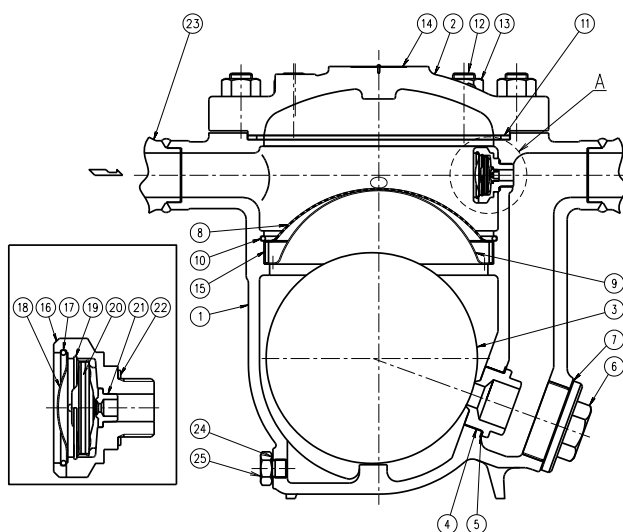

No.	Name	M*	R*	X*
4	Orifice		✓	
5	Orifice Gasket	✓	✓	
6	Orifice Plug			
7	Orifice Plug Gasket	✓	✓	
8	Screen		✓	
9	Screen Holder			
10	Snap Ring			
11	Cover Gasket	✓	✓	
12	Cover Bolt			
13	Cover Nut			
14	Nameplate			
15	Screen Holder Retainer			
16	X-element Case			✓
17	Snap Ring			✓
18	X-element Screen			✓
19	Spring Clip			✓
20	X-element			✓
21	Air Vent Valve Seat			✓
22	X-element Case Gasket	✓	✓	✓
23	Flange / Socket			
24	Drain Plug Gasket	✓	✓	
25	Drain Plug			

No.	Name	F*
1	Body	
2	Cover	
3	Float	✓

* Replacement parts are available only in the following kits:

M = Maintenance Kit; R = Repair Kit; F = Float; X = X-element Replacement Unit

Installation



Install properly and **DO NOT** use this product outside the recommended operating pressure, temperature and other specification ranges. Improper use may result in such hazards as damage to the product or malfunctions which may lead to serious accidents. Local regulations may restrict the use of this product to below the conditions quoted.



Use hoisting equipment for heavy objects (weighing approximately 20kg (44 lb) or more). Failure to do so may result in back strain or other injury if the object should fall.



Take measures to prevent people from coming into direct contact with product outlets. Failure to do so may result in burns or other injury from the discharge of fluids.

Installation, inspection, maintenance, repairs, disassembly, adjustment and valve opening/closing should be carried out only by trained maintenance personnel.

1. Before installation, be sure to remove all protective seals.
2. Before installing the product, open the inlet valve and blow out the piping to remove any piping scraps, dirt and oil. Close the inlet valve after blowdown.
3. Install the product so the arrow on the body is pointing in the direction of flow.
4. The product should be inclined no more than 5° horizontally and front-to-back.
5. Install a condensate outlet valve and outlet piping.
6. Open the inlet and outlet valves and check to make sure that the product functions properly.

If there is a problem, determine the cause using the “Troubleshooting” section in this manual.

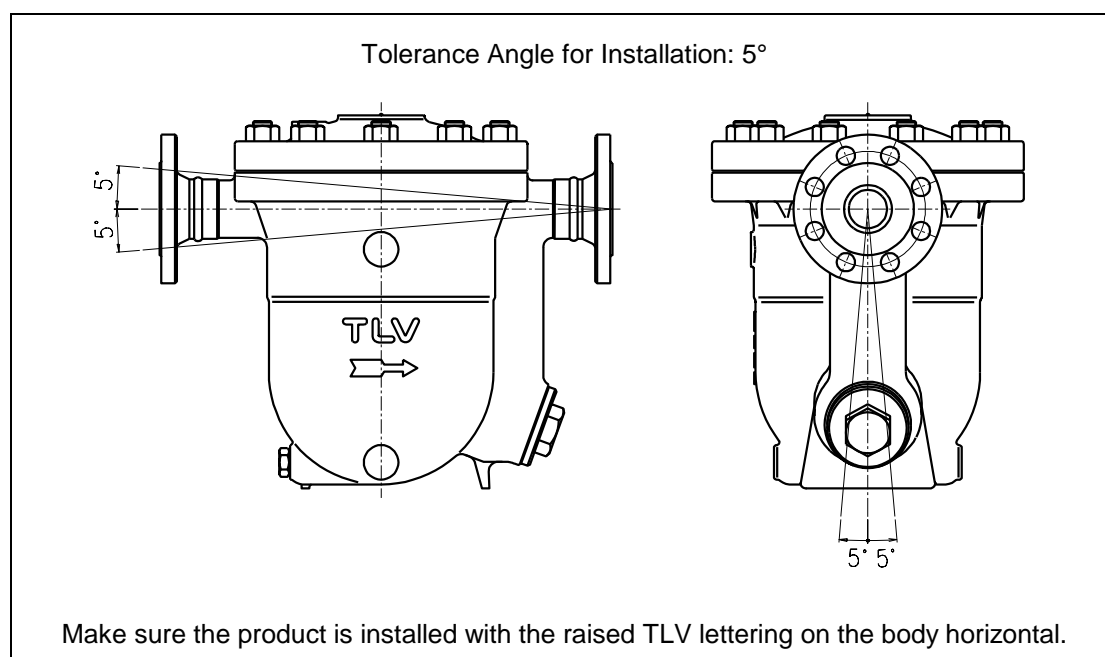

Maintenance



Take measures to prevent people from coming into direct contact with product outlets. Failure to do so may result in burns or other injury from the discharge of fluids.



Be sure to use only the recommended components when repairing the product, and NEVER attempt to modify the product in any way. Failure to observe these precautions may result in damage to the product or burns or other injury due to malfunction or the discharge of fluids.

Operational Check

A visual inspection of the following items should be done on a daily basis to determine whether the product is operating properly or has failed. Periodically (at least biannually) the operation should also be checked by using diagnostic equipment, such as a stethoscope or thermometer.

If the product should fail, it may cause damage to piping and equipment, resulting in faulty or low quality products or losses due to steam leakage.

- | | |
|-----------------------------------|---|
| Normal | : Condensate is discharged continuously, together with flash steam, and the sound of flow can be heard. If there is very little condensate, there is almost no sound of flow. |
| Blocked
(Discharge Impossible) | : No condensate is discharged. The trap is quiet and makes no noise, and the surface temperature of the trap is low. |
| Blowing | : Live steam continually flows from the outlet and there is a continuous metallic sound. |
| Steam Leakage | : Live steam is discharged through the trap outlet together with condensate, accompanied by a high-pitched sound. |

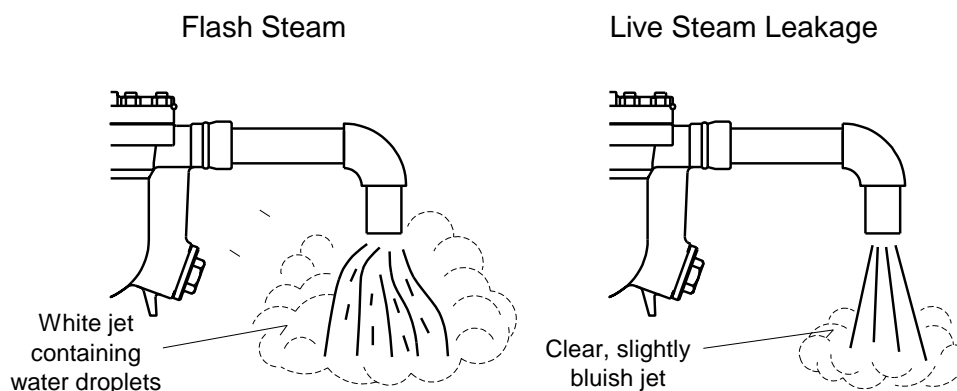

Parts Inspection

When parts have been removed, or during periodic inspections, use the following table to inspect the parts and replace any that are found to be defective.

Procedure
Gaskets: Check for warping or scratches
Screen: Check for clogging or corrosion
X-element: Check for scratches
Valve Seat: Check for scratches
Float: Check for scratches or dents
Orifice Opening: Check for dirt, oil film, scratches or wear
Body interior: Check for build-up

Disassembly/Reassembly



NEVER apply direct heat to the float. The float may explode due to increased internal pressure, causing accidents leading to serious injury or damage to property and equipment.



Use hoisting equipment for heavy objects (weighing approximately 20kg (44 lb) or more). Failure to do so may result in back strain or other injury if the object should fall.



When disassembling or removing the product, wait until the internal pressure equals atmospheric pressure and the surface of the product has cooled to room temperature. Disassembling or removing the product when it is hot or under pressure may lead to discharge of fluids, causing burns, other injuries or damage.

Use the following procedures to remove components. Use the same procedures in reverse to reassemble. (Installation, inspection, maintenance, repairs, disassembly, adjustment and valve opening/closing should be carried out only by trained maintenance personnel.)

Drain Plug

Part	During Disassembly	During Reassembly
Drain Plug	Remove with a socket wrench	Consult the table of tightening torques and tighten to the proper torque
Drain Plug Gasket	Remove the gasket and clean sealing surfaces	Replace with a new gasket; coat surfaces with anti-seize

Detaching/Reattaching the Cover and its Components

Part	During Disassembly	During Reassembly
Cover Nut	Remove with a socket wrench	Consult the table of tightening torques and tighten to the proper torque
Cover	Remove by lifting up and off	Make sure there are no pieces of the old gasket left on the sealing surfaces of the body and cover, align the arrows on the body and cover and reattach
Cover Gasket	Remove the gasket and clean sealing surfaces	Replace with a new gasket

Disassembly/Reassembly of the X-element Case and Components Inside the X-element Case

Part	During Disassembly	During Reassembly
X-element Case	Remove with a box wrench	Consult the table of tightening torques and tighten to the proper torque
X-element Case Gasket	Remove the gasket and clean sealing surfaces	Replace with a new gasket; coat surfaces with anti-seize
Snap Ring (X-element Case)	Pinch the insides together and remove from the X-element case	Insert securely into the guide in the X-element case
X-element Screen	Remove from the X-element case	Insert after making sure of the correct orientation
Spring Clip (X-element)	Pinch the insides together and remove from the X-element case	Insert securely into the guide in the X-element case
X-element	Remove from the X-element case	Insert after making sure of the correct orientation

NOTE: Do not attempt to remove the press-in air vent valve seat from the X-element case.

Disassembly/Reassembly of Components Inside the Body

NOTE: The X-element case must be removed before the float can be removed.

Part	During Disassembly	During Reassembly
Snap Ring	Pinch the insides together and remove from the body	Insert securely into the groove in the body
Screen	Lift straight up and out while turning	Place on the screen holder, making sure that the top of the screen does not stick up out of the body
Screen Holder Retainer	Remove without bending	Place on the screen holder without tilting
Screen Holder	Remove without bending	Place on the ledge inside the body, making sure the rounded side is on top
Float	Remove, being careful not to scratch the polished surface	Insert, being careful not to scratch the polished surface
Orifice Plug	Remove with a box wrench	Consult the table of tightening torques and tighten to the proper torque
Orifice Plug Gasket	Remove the gasket and clean sealing surfaces	Replace with a new gasket; coat surfaces with anti-seize
Orifice	Remove with a box wrench	Consult the table of tightening torques and tighten to the proper torque
Orifice Gasket	Remove the gasket and clean sealing surfaces	Replace with a new gasket; coat surfaces with anti-seize

Table of Tightening Torques

Part Name	Torque		Distance Across Flats	
	N·m	(lb·ft)	mm	(in)
Orifice	600	(440)	46	(1 ¹³ / ₁₆)
Orifice Plug	800	(590)	46	(1 ¹³ / ₁₆)
Cover Nut	200	(150)	30	(1 ³ / ₁₆)
X-element Case	150	(110)	50	(1 ³¹ / ₃₂)
Drain Plug	100	(73)	26	(1)

NOTE: -Coat all threaded portions with anti-seize. (1 N·m ≈ 10 kg·cm)
 -If drawings or other special documentation were supplied for the product, any torque given there takes precedence over values shown here.

Exploded View

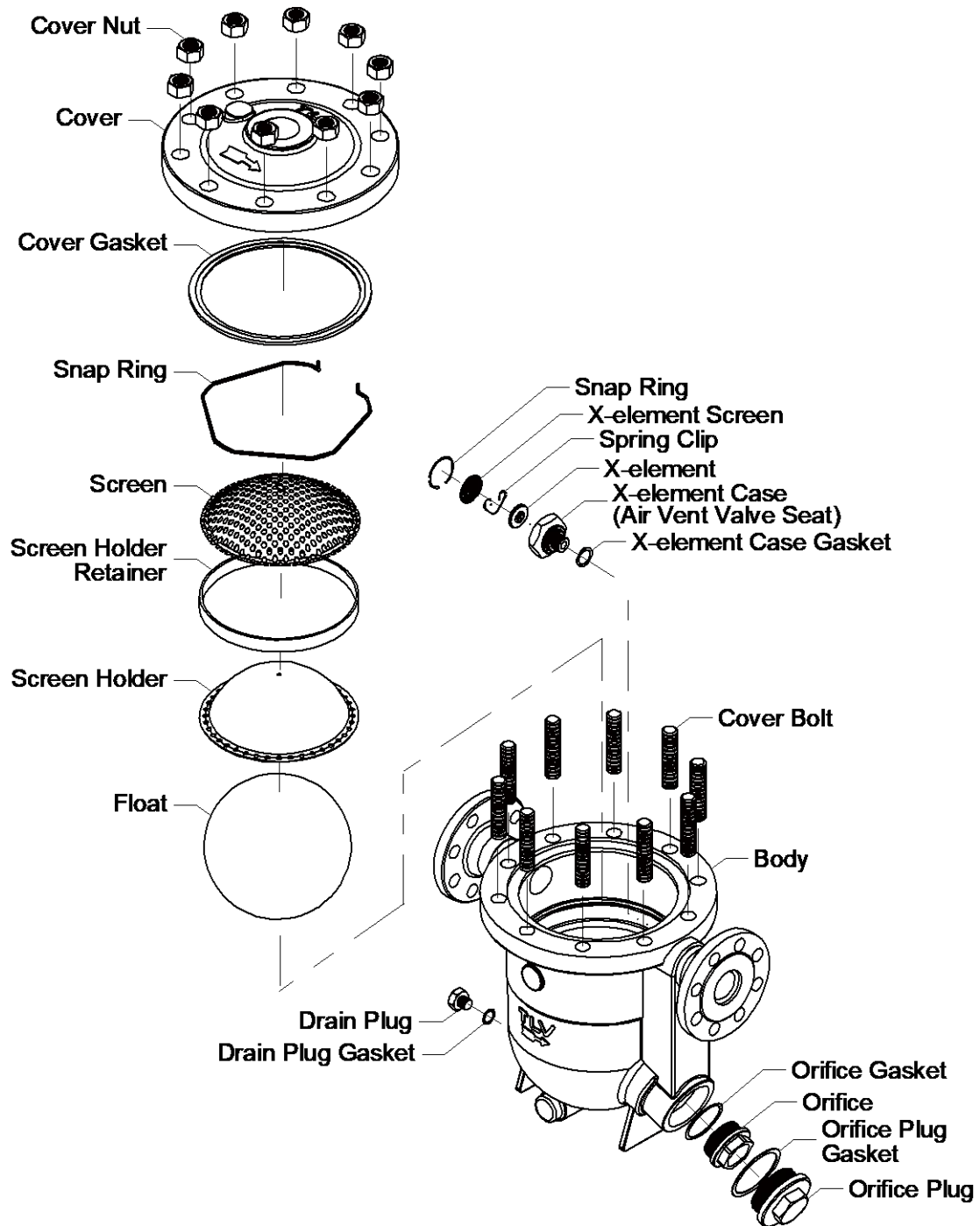

Instructions for Plug/Holder Disassembly and Reassembly

The seal on the threaded plugs/holders found on TLV products is formed by a flat metal gasket. There are various installation orientations for the gaskets, such as horizontal, diagonal and downward, and the gasket may be pinched in the thread recesses during assembly.

Instructions for Disassembly and Reassembly

1. Remove the plug/holder using a tool of the specified size (distance across flats).
2. The gasket should not be reused. Be sure to replace it with a new gasket.
3. Clean the gasket surfaces of the plug/holder and the product body using a rag and/or cleaning agents, then check to make sure the surfaces are not scratched or deformed.
4. Coat both the gasket surface of the plug/holder and the threads of the plug/holder with anti-seize, then press the gasket onto the center of the gasket surface of the plug/holder, making sure the anti-seize affixes the gasket tightly to the plug/holder. Check to make sure the gasket is not caught in the recesses of the threads.
5. Hold the plug/holder upside down to make sure that the anti-seize makes the gasket stick to the plug/holder even when the plug/holder is held upside down.
6. Screw the plug/holder by hand into the product body while making sure that the gasket remains tightly affixed to the center of the gasket surface of the plug/holder. Make sure the entire gasket is making contact with the gasket surface of the product body. It is important at this point to make sure the gasket is not pinched in the thread recesses of the plug/holder.
7. Tighten the plug/holder to the proper torque.
8. Next, begin the supply of steam and check to make sure there is no leakage from the part just tightened. If there is leakage, immediately close the inlet valve and, if there is a bypass valve, take the necessary steps to release any residual pressure. After the surface of the product cools to room temperature, repeat the procedure beginning from step 1.

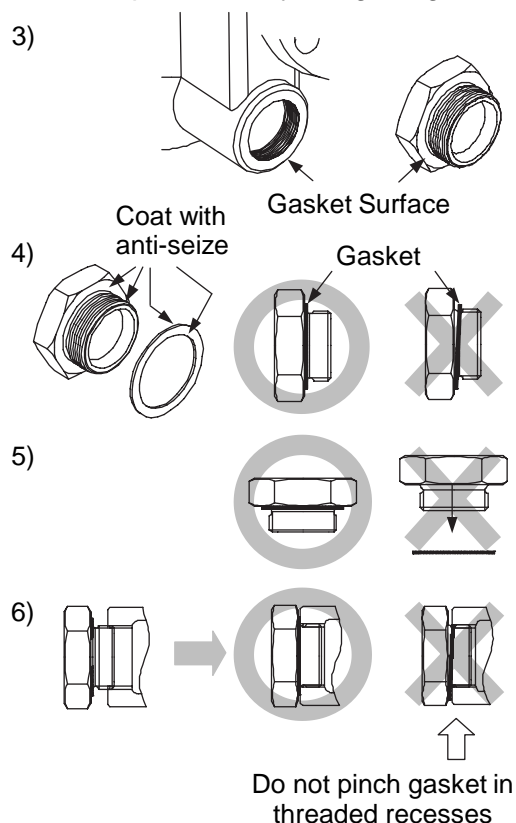

Troubleshooting



NEVER apply direct heat to the float. The float may explode due to increased internal pressure, causing accidents leading to serious injury or damage to property and equipment.



When disassembling or removing the product, wait until the internal pressure equals atmospheric pressure and the surface of the product has cooled to room temperature. Disassembling or removing the product when it is hot or under pressure may lead to discharge of fluids, causing burns, other injuries or damage.

When the product fails to operate properly, use the following table to locate the cause and remedy.

Problem	Cause	Remedy
No condensate is discharged (blocked) or discharge is poor	The float is damaged or filled with condensate	Replace with a new float
	The orifice opening, screen or piping are clogged with rust and scale	Clean parts
	The X-element is scratched or damaged	Replace with a new X-element
	Steam-locking has occurred	Perform a bypass blowdown or close the trap inlet valve and allow the trap to cool
	The trap operating pressure exceeds the maximum specified pressure, or whether there is insufficient pressure differential between the trap inlet and outlet	Compare specifications and actual operating conditions
Steam is discharged or leaks from the outlet (blowing) (steam leakage)	Build-up on the seating surface of the orifice or rust and scale build-up beneath the float	Clean parts
	Scratches on the orifice	Replace with a new orifice
	The float is misshapen or has a build-up	Clean or replace with a new float
	Improper installation orientation	Correct the installation
	Trap vibration	Lengthen the inlet piping and fasten it securely
The air vent valve seating area of the X-element and/or air vent valve seat have a build-up or are scratched	Clean the air vent valve seating area of the X-element and/or air vent valve seat or replace the X-element unit	
Steam is leaking from a place other than the outlet	Gasket deterioration or damage	Replace with new gasket(s)
	Improper tightening torques were used	Tighten to the proper torque
Float frequently becomes damaged	Water hammer has occurred	Study and correct the piping

NOTE: When replacing parts with new, use the parts list for reference, and replace with parts from the Maintenance Kit, Repair Kit, etc. Please note that replacement parts are only available as part of a replacement parts kit.

Product Warranty

1. Warranty Period
One year following product delivery.
2. Warranty Coverage
TLV CO., LTD. warrants this product to the original purchaser to be free from defective materials and workmanship. Under this warranty, the product will be repaired or replaced at our option, without charge for parts or labor.
3. This product warranty will not apply to cosmetic defects, nor to any product whose exterior has been damaged or defaced; nor does it apply in the following cases:
 - 1) Malfunctions due to improper installation, use, handling, etc., by other than TLV CO., LTD. authorized service representatives.
 - 2) Malfunctions due to dirt, scale, rust, etc.
 - 3) Malfunctions due to improper disassembly and reassembly, or inadequate inspection and maintenance by other than TLV CO., LTD. authorized service representatives.
 - 4) Malfunctions due to disasters or forces of nature.
 - 5) Accidents or malfunctions due to any other cause beyond the control of TLV CO., LTD.
4. Under no circumstances will TLV CO., LTD. be liable for consequential economic loss damage or consequential damage to property.

* * * * *

For Service or Technical Assistance:

Contact your TLV representative or your regional TLV office.

Manufacturer

TLV CO., LTD.

881 Nagasuna, Noguchi
Kakogawa, Hyogo 675-8511, JAPAN
Tel: 81-(0)79-427-1800

Options

The options shown below are available for this product on request. Please compare with the product you received.

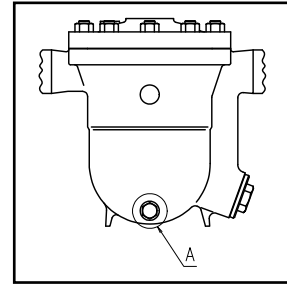

Options for Area A (standard: with drain plug)

Without Drain Plug

