

ISO 9001
ISO 14001



Manufacturer

TLV CO., LTD.

Kakogawa, Japan

is approved by LRQA Ltd. to ISO 9001/14001



Instruction Manual

Free Float Steam Trap

Featured Model: JH7.5R-P

Optional Models: JH7.5R-W/JH7.5R-F/JH7.5R-V

172-65462M-06

Publication date 20 October 2022

Copyright © 2022 TLV CO., LTD.

Table of Contents

- Introduction 3
- Safety Considerations 4
- Checking the Piping 6
- Operation 7
- Specifications 8
- Configuration 9
- Installation 10
- Maintenance 11
- Disassembly/Reassembly 13
- Instructions for Plug/Holder Disassembly and Reassembly 16
- Troubleshooting 17
- TLV EXPRESS LIMITED WARRANTY 18
- Service 20
- Options 21

Introduction

Thank you for purchasing the TLV free float steam trap.

This product has been thoroughly inspected before being shipped from the factory. When the product is delivered, before doing anything else, check the specifications and external appearance to make sure nothing is out of the ordinary. Also be sure to read this manual carefully before use and follow the instructions to be sure of using the product properly.

This instruction manual is edited based on the JH-P Series (with cover plug). The JH-W Series (with socket welded cover connection), JH-F Series (with flanged cover connection) and JH-V Series (with manual air vent valve) are described at the end of this manual in the 'Option' section.

This free float steam trap employs a hinge-less and lever-less free float to rapidly, automatically and continuously discharge the inflowing condensate that is continuously generated inside the equipment, thus preventing the accumulation of condensate and thereby improving the heat transfer efficiency of the equipment.

This free float steam trap employs a hinge-less and lever-less free float to rapidly, automatically and continuously discharge the inflowing condensate that is continuously generated inside the equipment, thus preventing the accumulation of condensate and thereby improving the heat transfer efficiency of the equipment.

If detailed instructions for special order specifications or options not contained in this manual are required, please contact TLV for full details.

This instruction manual is intended for use with the model(s) listed on the front cover. It is necessary not only for installation, but for subsequent maintenance, disassembly/reassembly and troubleshooting. Please keep it in a safe place for future reference.

Safety Considerations

- Read this section carefully before use and be sure to follow the instructions.
- Installation, inspection, maintenance, repairs, disassembly, adjustment and valve opening/closing should be carried out only by trained maintenance personnel.
- The precautions listed in this manual are designed to ensure safety and prevent equipment damage and personal injury. For situations that may occur as a result of erroneous handling, three different types of cautionary items are used to indicate the degree of urgency and the scale of potential damage and danger: DANGER, WARNING and CAUTION.
- The three types of cautionary items above are very important for safety: be sure to observe all of them as they relate to installation, use, maintenance and repair. Furthermore, TLV accepts no responsibility for any accidents or damage occurring as a result of failure to observe these precautions.

Cautionary items and definitions



Danger

Indicates an urgent situation which poses a threat of death or serious injury



Warning

Indicates that there is a potential threat of death or serious injury



Caution

Indicates that there is a possibility of injury or equipment/product damage

Safety Considerations for the Product



Warning

NEVER apply direct heat to the float. The float may explode due to increased internal pressure, causing accidents leading to serious injury or damage to property and equipment.



Caution

Install properly and DO NOT use this product outside the recommended operating pressure, temperature and other specification ranges. Improper use may result in such hazards as damage to the product or malfunctions that may lead to serious accidents. Local regulations may restrict the use of this product to below the conditions quoted.



Caution

DO NOT use this product in excess of the maximum operating pressure differential. Such use could make discharge impossible (blocked).



Caution

Use hoisting equipment for heavy objects (weighing approximately 20 kg (44 lb) or more). Failure to do so may result in back strain or other injury if the object should fall.



Caution

Take measures to prevent people from coming into direct contact with product outlets. Failure to do so may result in burns or other injury from the discharge of fluids.



Caution

When disassembling or removing the product, wait until the internal pressure equals atmospheric pressure and the surface of the product has cooled to room temperature. Disassembling or removing the product when it is hot or under pressure may lead to discharge of fluids, causing burns, other injuries or damage.



Caution

Be sure to use only the recommended components when repairing the product, and NEVER attempt to modify the product in any way. Failure to observe these precautions may result in damage to the product and burns or other injury due to malfunction or the discharge of fluids.



Caution

Use only under conditions in which no freeze-up will occur. Freezing may damage the product, leading to fluid discharge, which may cause burns or other injury.



Caution

Use only under conditions in which no water hammer will occur. The impact of water hammer may damage the product, leading to fluid discharge, which may cause burns or other injury.

Checking the Piping



Caution

Use only under conditions in which no water hammer will occur. The impact of water hammer may damage the product, leading to fluid discharge, which may cause burns or other injury.

Check to make sure that the pipes to be connected to the product have been installed properly.

1. Is the pipe diameter suitable?
2. Is the piping where the product is to be installed horizontal?
3. Has sufficient space been secured for maintenance?
4. Have isolation valves been installed at the inlet and outlet? If the outlet is subject to back pressure, has a check valve (TLV-CK) been installed?
5. Is a bypass valve installed?
6. Is the inlet pipe as short as possible, with as few bends as possible, and installed so the liquid will flow naturally down into the product?
7. Has the piping work been done correctly, as shown in the figures below?

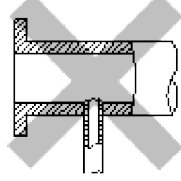
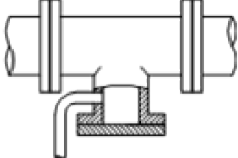
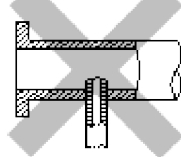
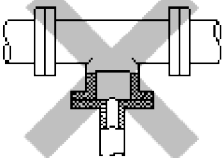
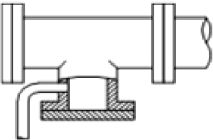
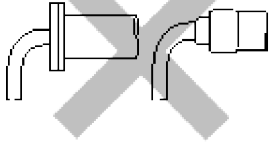
Requirement	Correct	Incorrect
Install catchpot with the proper diameter.		 <p>Diameter is too small.</p>
Make sure the flow of condensate is not obstructed.		 <p>Diameter is too small and inlet protrudes into pipe interior.</p>
To prevent rust and scale from flowing into the product, the inlet pipe should be connected 25 to 50 mm above the base of the T-pipe.		 <p>Rust and scale flow into the trap with the condensate.</p>
When installing on the blind end, make sure the flow of condensate is not obstructed.		 <p>Condensate collects in the pipe.</p>

Operation

Principles of condensate discharge:

As much air as possible should be eliminated at start-up using a bypass valve or blowdown line.

1. Condensate Discharge

As steam is supplied, condensate flow begins. The rising condensate level causes the float to rise due to buoyancy, opening the orifice (A) and allowing condensate to be discharged.

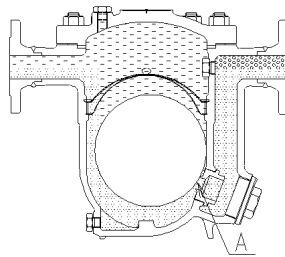

2. Discharge of Large Quantities of Condensate

Increases in the condensate inflow rate cause the condensate level in the trap to rise. The float consequently rises and enlarges the opening of the orifice (A), allowing more condensate to be discharged. In this manner, continuous condensate discharge occurs while the opening size of the orifice varies depending on the condensate flow rate.

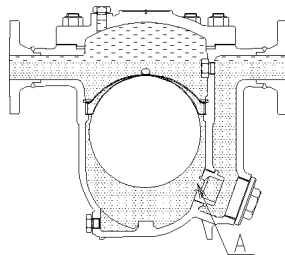

3. Closed Position

When the condensate flow rate decreases, the float falls, closing off the orifice (A) opening. A water seal is maintained at all times over the orifice (A) to prevent steam loss.

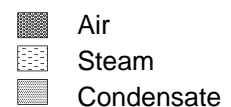
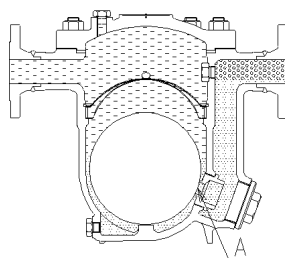

Specifications



Caution

Install properly and DO NOT use this product outside the recommended operating pressure, temperature and other specification ranges. Improper use may result in such hazards as damage to the product or malfunctions that may lead to serious accidents. Local regulations may restrict the use of this product to below the conditions quoted.

DO NOT use this product in excess of the maximum operating pressure differential. Such use could make discharge impossible (blocked).

Use only under conditions in which no freeze-up will occur. Freezing may damage the unit, leading to fluid discharge, which may different cause burns or other injury.

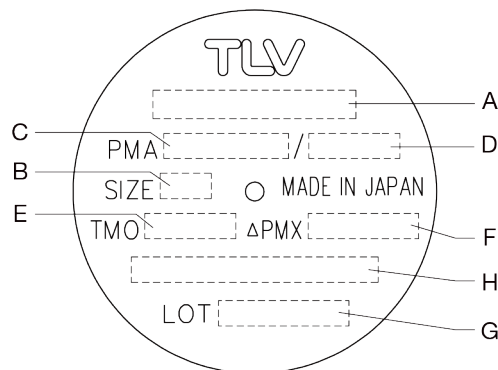

A	Model
B	Nominal Diameter
C	Maximum Allowable Pressure (PMA) ⁰¹
D	Maximum Allowable Temperature (TMA) ⁰¹
E	Maximum Operating Temperature (TMO)
F	Maximum Differential Pressure (PMX)
G	Production Lot No.
H	Valve No. ⁰²

⁰¹Maximum allowable pressure (PMA) and maximum allowable temperature (TMA) are PRESSURE SHELL DESIGN CONDITIONS, **NOT** OPERATING CONDITIONS.

⁰²Valve No. is displayed for products with options. This item is omitted from the nameplate when there are no options.

Configuration

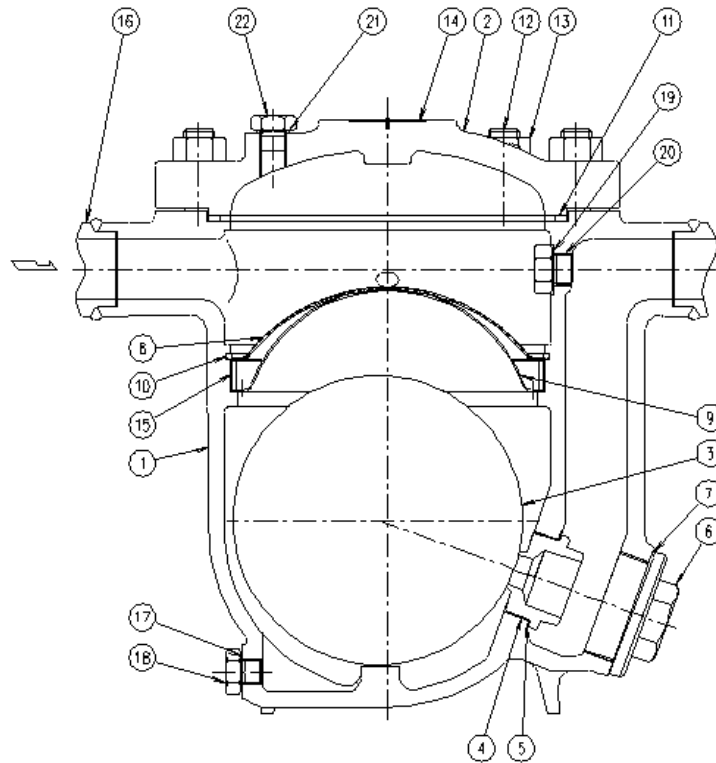

No.	Part Name	Maintenance Kit	Repair Kit	Float
1	Body			
2	Cover			
3	Float			✓
4	Orifice		✓	
5	Orifice Gasket	✓	✓	
6	Orifice Plug			
7	Orifice Plug Gasket	✓	✓	
8	Screen		✓	
9	Screen Holder			
10	Snap Ring			
11	Cover Gasket	✓	✓	
12	Cover Bolt			
13	Cover Nut			
14	Nameplate			
15	Screen Holder Retainer			
16	Flange/Socket			
17	Drain Plug Gasket	✓	✓	
18	Drain Plug			
19	Plug Gasket	✓	✓	
20	Plug			
21	Cover Plug Gasket	✓	✓	
22	Cover Plug			

Installation



Caution

Install properly and DO NOT use this product outside the recommended operating pressure, temperature and other specification ranges. Improper use may result in such hazards as damage to the product or malfunctions that may lead to serious accidents. Local regulations may restrict the use of this product to below the conditions quoted.

Use hoisting equipment for heavy objects (weighing approximately 20 kg (44 lb) or more). Failure to do so may result in back strain or other injury if the object should fall.

Take measures to prevent people from coming into direct contact with product outlets. Failure to do so may result in burns or other injury from the discharge of fluids.

Installation, inspection, maintenance, repairs, disassembly and adjustment and valve opening/closing should be carried out only by trained maintenance personnel.

1. Before installation, be sure to remove all protective seals.
2. Before installing the product, open the inlet valve and blow out the piping to remove any piping scraps, dirt and oil. Close the inlet valve after blowdown.
3. Install the product so the arrow on the body is pointing in the direction of flow.
4. The product should be inclined no more than 5° horizontally and front-to-back.
5. Install a condensate outlet valve and outlet piping.
6. Air in the system at start-up should be discharged using a bypass valve or blowdown line.
7. Open the inlet and outlet valves and ensure that the product functions properly.

If there is a problem, determine the cause using the "Troubleshooting" section in this manual.

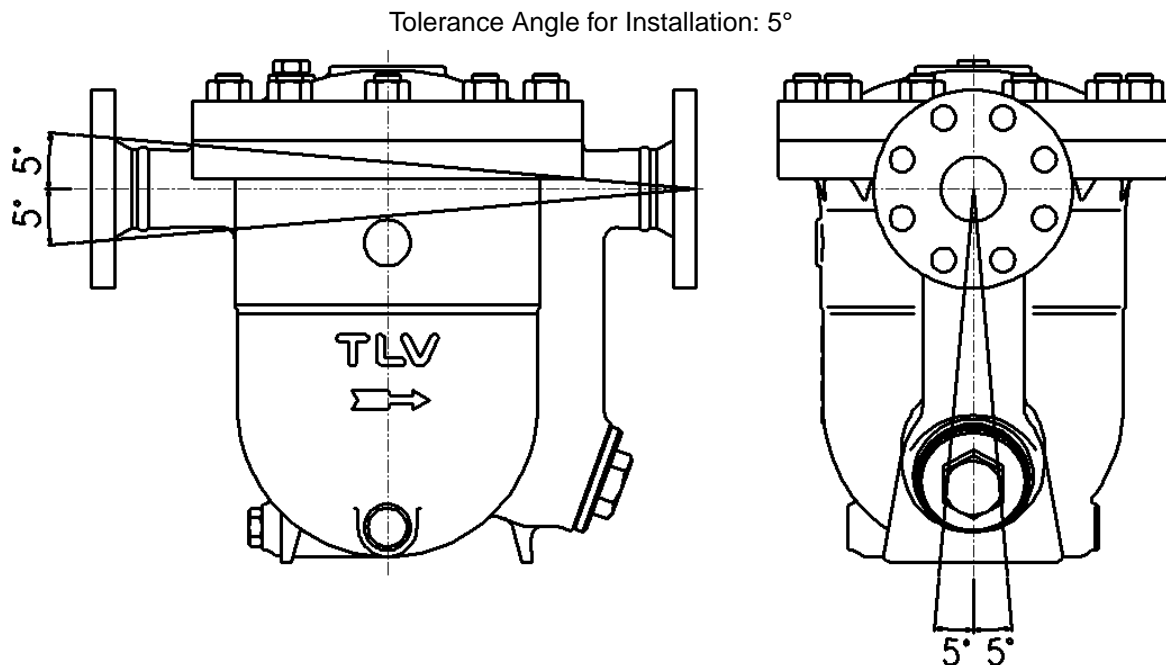

Make sure the product is installed with the raised TLV lettering on the body horizontal.

Maintenance



Caution

Take measures to prevent people from coming into direct contact with product outlets. Failure to do so may result in burns or other injury from the discharge of fluids.

Be sure to use only the recommended components when repairing the product, and NEVER attempt to modify the product in any way. Failure to observe these precautions may result in damage to the product and burns or other injury due to malfunction or the discharge of fluids.

Operational Check

A visual inspection of the following items should be done on a daily basis to determine whether the product is operating properly or has failed. Periodically (at least biannually) the operation should also be checked by using diagnostic equipment such as a stethoscope, thermometer, TLV Pocket TrapMan or TLV TrapMan.

If the product should fail, it may cause damage to piping and equipment, resulting in faulty or low quality products or losses due to steam leakage.

Normal:	Condensate is discharged continuously, together with flash steam, and the sound of flow can be heard. If there is very little condensate, there is almost no sound of flow.
Blocked (Discharge Impossible):	No condensate is discharged. The product is quiet and makes no noise, and the surface temperature of the product is low.
Blowing:	Live steam continually flows from the outlet and there is a continuous metallic sound.
Steam Leakage:	Live steam is discharged through the product outlet together with condensate, accompanied by a high-pitched sound.

(When conducting a visual inspection, flash steam is sometimes mistaken for steam leakage. For this reason, the use of a steam trap diagnostic instrument such as TLV TrapMan in conjunction with the visual inspection is highly recommended.)

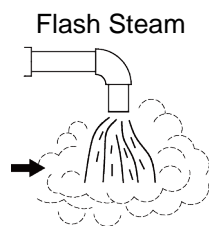

White jet containing water droplets

Live Steam Leakage

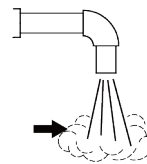

Clear, slightly bluish jet

Parts Inspection

When parts have been removed, or during periodic inspections, use the following table to inspect the parts and replace any that are found to be defective.

Gaskets: Check for warping or scratches

Screen: Check for clogging or corrosion

Float: Check for scratches or dents

Body Interior: Check for build-up

Orifice Opening: Check for dirt, oil film, wear or scratches

Disassembly/Reassembly



Warning

NEVER apply direct heat to the float. The float may explode due to increased internal pressure, causing accidents leading to serious injury or damage to property and equipment.



Caution

Use hoisting equipment for heavy objects (weighing approximately 20 kg (44 lb) or more). Failure to do so may result in back strain or other injury if the object should fall.

When disassembling or removing the product, wait until the internal pressure equals atmospheric pressure and the surface of the product has cooled to room temperature.

Disassembling or removing the product when it is hot or under pressure may lead to discharge of fluids, causing burns, other injuries or damage.

Use the following procedures to remove components. Use the same procedures in reverse to reassemble. (Installation, inspection, maintenance, repairs, disassembly, adjustment and valve opening/closing should be carried out only by trained maintenance personnel.)

Drain Plug

Part Name & No.	During Disassembly	During Reassembly
Drain Plug 18	Remove with a socket wrench	Consult the table of tightening torques and tighten to the proper torque
Drain Plug Gasket 19	Remove the gasket and clean sealing surfaces	Replace with a new gasket; coat surfaces with anti-seize

Detaching/Reattaching the Cover and its Components

Part Name & No.	During Disassembly	During Reassembly
Cover Nut 13	Remove with a socket wrench	Consult the table of tightening torques and tighten to the proper torque
Cover 2	Remove, being careful not to scratch the gasket sealing surface	Make sure there are no pieces of the old gasket left on the sealing surfaces of the body and cover, align the arrows on the body and cover and reattach
Cover Gasket 11	Remove the gasket and clean sealing surfaces	Replace with a new gasket
Cover Plug 22	Remove with a socket wrench	Consult the table of tightening torques and tighten to the proper torque
Cover Plug Gasket 21	Remove the gasket and clean sealing surfaces	Replace with a new gasket; coat surfaces with anti-seize

Disassembly/Reassembly of Components Inside the Body



Note

The plug (inside the body) must be removed before the float can be removed.

Part Name	During Disassembly	During Reassembly
Plug (inside the body) 20	Remove with a socket wrench	Consult the table of tightening torques and tighten to the proper torque
Plug Gasket 19	Remove the gasket and clean sealing surfaces	Replace with a new gasket; coat surfaces with anti-seize
Snap Ring 10	Pinch insides together and remove from the body	Insert securely into the groove in the body
Screen 8	Remove by grasping the wire ring and lifting straight up and out	Set the screen on the screen holder and screen holder retainer and insert as far as the snap ring groove
Screen Holder Retainer 15	Remove without bending	Place on the screen holder without tilting
Screen Holder 9	Remove without bending	Place on the ledge inside the body, making sure the rounded side is on top
Float 3	Remove, being careful not to scratch the polished surface	Insert, being careful not to scratch the polished surface
Orifice Plug 6	Remove with a socket wrench	Consult the table of tightening torques and tighten to the proper torque
Orifice Plug Gasket 7	Remove the gasket and clean sealing surfaces	Replace with a new gasket; coat surfaces with anti-seize
Orifice 4	Remove with a socket wrench	Consult the table of tightening torques and tighten to the proper torque
Orifice Gasket 5	Remove the gasket and clean sealing surfaces	Replace with a new gasket; coat surfaces with anti-seize

Table of Tightening Torques

Part Name & No.	Torque N·m	Distance Across Flats mm
Orifice 4	600	46
Orifice Plug 6	800	46
Cover Nut 13	200	30
Cover Plug (JH7.5R-P) 22	100	26
Plug (inside the body) 20	150	27
Drain Plug 18	100	26



Note

- Coat all threaded portions and valve seat gasket with anti-seize.
- If drawings or other special documentation were supplied for the product, any torque given there takes precedence over values shown here.

Exploded View

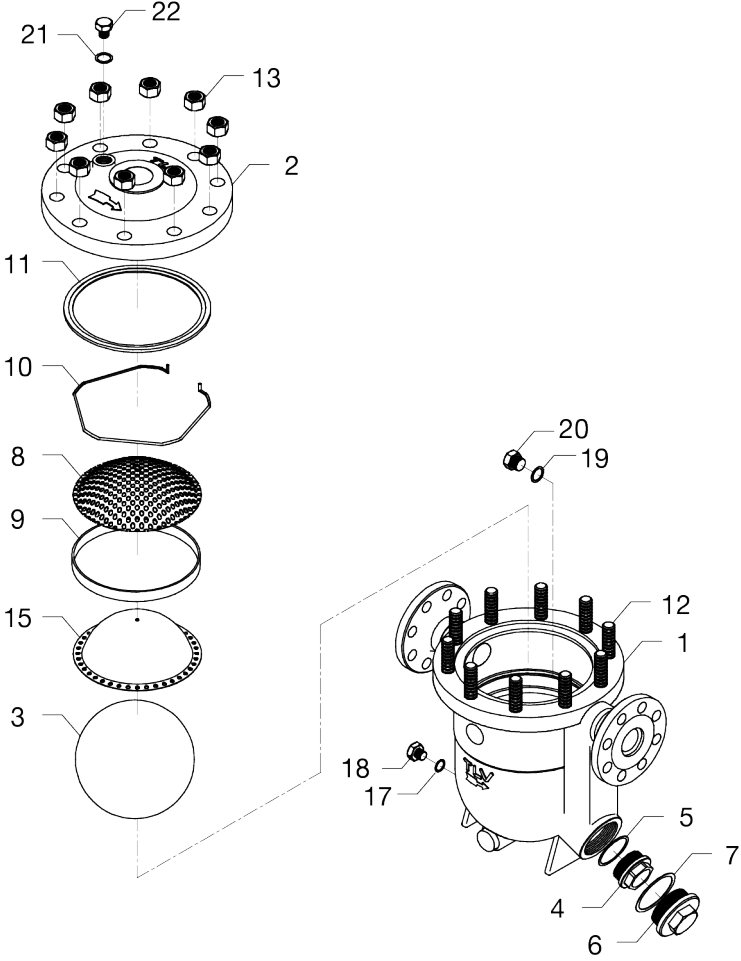

No.	Part Name	No.	Part Name
1	Body	12	Cover Bolt
2	Cover	13	Cover Nut
3	Float	14	Nameplate
4	Orifice	15	Screen Holder Retainer
5	Orifice Gasket	16	Flange/Socket
6	Orifice Plug	17	Drain Plug Gasket
7	Orifice Plug Gasket	18	Drain Plug
8	Screen	19	Plug Gasket
9	Screen Holder	20	Plug
10	Snap Ring	21	Cover Plug Gasket
11	Cover Gasket	22	Cover Plug

Instructions for Plug/Holder Disassembly and Reassembly

The seal on the threaded plugs/holders found on TLV products is formed by a flat metal gasket. There are various installation orientations for the gaskets, such as horizontal, diagonal and downward, and the gasket may be pinched in the thread recesses during assembly.

Instructions for Disassembly and Reassembly

1. Remove the plug/holder using a tool of the specified size (distance across flats).
2. The gasket should not be reused. Be sure to replace it with a new gasket.
3. Clean the gasket surfaces of the plug/holder and the product body using a rag and/or cleaning agents, then check to make sure the surfaces are not scratched or deformed.

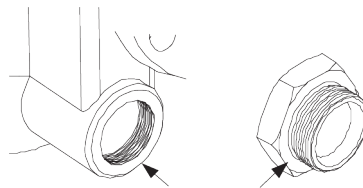

4. Coat both the gasket surface of the plug/holder and the threads of the plug/holder with anti-seize, then press the gasket onto the center of the gasket surface of the plug/holder, making sure the anti-seize affixes the gasket tightly to the plug/holder. Check to make sure the gasket is not caught in the recesses of the threads.

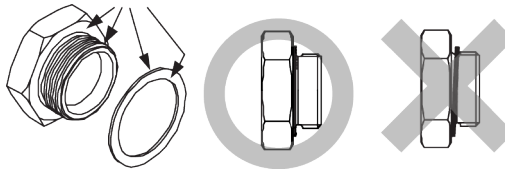

5. Hold the plug/holder upside down to make sure that the anti-seize makes the gasket stick to the plug/holder even when the plug/holder is held upside down.

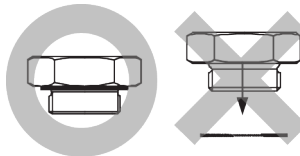

6. Screw the plug/holder by hand into the product body while making sure that the gasket remains tightly affixed to the center of the gasket surface of the plug/holder. Make sure the entire gasket is making contact with the gasket surface of the product body. It is important at this point to make sure the gasket is not pinched in the thread recesses of the plug/holder.

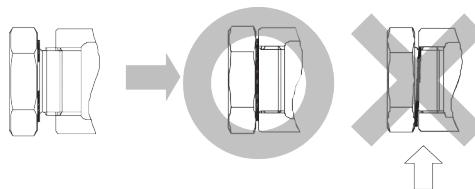

7. Tighten the plug/holder to the proper torque.
8. Next, begin the supply of steam and check to make sure there is no leakage from the part just tightened. If there is leakage, immediately close the inlet valve and, if there is a bypass valve, take the necessary steps to release any residual pressure. After the surface of the product cools to room temperature, repeat the procedure beginning from step 1.

Troubleshooting



Warning

NEVER apply direct heat to the float. The float may explode due to increased internal pressure, causing accidents leading to serious injury or damage to property and equipment.



Caution

When disassembling or removing the product, wait until the internal pressure equals atmospheric pressure and the surface of the product has cooled to room temperature. Disassembling or removing the product when it is hot or under pressure may lead to discharge of fluids, causing burns, other injuries or damage.

If the product fails to operate properly, use the following table to locate the cause and remedy.

Problem	Cause	Remedy
No condensate is discharged (blocked) or discharge is poor	The float is damaged or filled with condensate	Replace with a new float
	The orifice opening, screen or piping are clogged with rust and scale	Clean parts
	Air binding has occurred	Perform a bypass blowdown or consider switching to a product with a built-in air vent or air vent valve
	Steam-locking has occurred	Perform a bypass blowdown or close the product inlet valve and allow the product to cool
	The product operating pressure exceeds the maximum specified pressure, or whether there is insufficient pressure differential between the product inlet and outlet	Compare specifications and actual operating conditions
Steam is discharged or leaks from the outlet (blowing) (steam leakage)	Build-up on the seating surface of the orifice or rust and scale build-up beneath the float	Clean parts
	Scratches on the orifice	Replace with a new orifice
	The float is misshapen or has a build-up	Clean or replace with a new float
	Improper installation orientation	Correct the installation
	Product vibration	Lengthen the inlet piping and fasten it securely
Steam is leaking from a place other than the outlet	Gasket deterioration or damage	Replace with new gasket(s)
	Improper tightening torques were used	Tighten to the proper torque
Float frequently becomes damaged	Water hammer has occurred	Study and correct the piping



Note

When replacing parts with new, use the parts list for reference, and replace with parts from the Maintenance Kit, Repair Kit, etc. Please note that replacement parts are only available as part of a replacement parts kit.

TLV EXPRESS LIMITED WARRANTY

Subject to the limitations set forth below, TLV CO., LTD., a Japanese corporation (“**TLV**”), warrants that products which are sold by it, TLV International Inc. (“**TII**”) or one of its group companies excluding TLV Corporation (a corporation of the United States of America), (hereinafter the “**Products**”) are designed and manufactured by TLV, conform to the specifications published by TLV for the corresponding part numbers (the “**Specifications**”) and are free from defective workmanship and materials. The party from whom the Products were purchased shall be known hereinafter as the “**Seller**”. With regard to products or components manufactured by unrelated third parties (the “**Components**”), TLV provides no warranty other than the warranty from the third party manufacturer(s), if any.

Exceptions to Warranty

This warranty does not cover defects or failures caused by:

1. improper shipping, installation, use, handling, etc., by persons other than TLV, TII or TLV group company personnel, or service representatives authorized by TLV; or
2. dirt, scale or rust, etc.; or
3. improper disassembly and reassembly, or inadequate inspection and maintenance by persons other than TLV or TLV group company personnel, or service representatives authorized by TLV; or
4. disasters or forces of nature or Acts of God; or
5. abuse, abnormal use, accidents or any other cause beyond the control of TLV, TII or TLV group companies; or
6. improper storage, maintenance or repair; or
7. operation of the Products not in accordance with instructions issued with the Products or with accepted industry practices; or
8. use for a purpose or in a manner for which the Products were not intended; or
9. use of the Products in a manner inconsistent with the Specifications; or
10. use of the Products with Hazardous Fluids (fluids other than steam, air, water, nitrogen, carbon dioxide and inert gases (helium, neon, argon, krypton, xenon and radon)); or
11. failure to follow the instructions contained in the TLV Instruction Manual for the Product.

Duration of Warranty

This warranty is effective for a period of one (1) year after delivery of Products to the first end user. Notwithstanding the foregoing, asserting a claim under this warranty must be brought within three (3) years after the date of delivery to the initial buyer if not sold initially to the first end user.

ANY IMPLIED WARRANTIES NOT NEGATED HEREBY WHICH MAY ARISE BY OPERATION OF LAW, INCLUDING THE IMPLIED WARRANTIES OF MERCHANTABILITY AND FITNESS FOR A PARTICULAR PURPOSE AND ANY EXPRESS WARRANTIES NOT NEGATED HEREBY, ARE GIVEN SOLELY TO THE INITIAL BUYER AND ARE LIMITED IN DURATION TO ONE (1) YEAR FROM THE DATE OF SHIPMENT BY THE SELLER.

Exclusive Remedy

THE EXCLUSIVE REMEDY UNDER THIS WARRANTY, UNDER ANY EXPRESS WARRANTY OR UNDER ANY IMPLIED WARRANTIES NOT NEGATED HEREBY (INCLUDING THE IMPLIED WARRANTIES OF MERCHANTABILITY AND FITNESS FOR A PARTICULAR PURPOSE), IS **REPLACEMENT**; PROVIDED: (a) THE CLAIMED DEFECT IS

REPORTED TO THE SELLER IN WRITING WITHIN THE WARRANTY PERIOD, INCLUDING A DETAILED WRITTEN DESCRIPTION OF THE CLAIMED DEFECT AND HOW AND WHEN THE CLAIMED DEFECTIVE PRODUCT WAS USED; AND (b) THE CLAIMED DEFECTIVE PRODUCT AND A COPY OF THE PURCHASE INVOICE IS RETURNED TO THE SELLER, FREIGHT AND TRANSPORTATION COSTS PREPAID, UNDER A RETURN MATERIAL AUTHORIZATION AND TRACKING NUMBER ISSUED BY THE SELLER. ALL LABOR COSTS, SHIPPING COSTS, AND TRANSPORTATION COSTS ASSOCIATED WITH THE RETURN OR REPLACEMENT OF THE CLAIMED DEFECTIVE PRODUCT ARE SOLELY THE RESPONSIBILITY OF BUYER OR THE FIRST END USER. THE SELLER RESERVES THE RIGHT TO INSPECT ON THE FIRST END USER'S SITE ANY PRODUCTS CLAIMED TO BE DEFECTIVE BEFORE ISSUING A RETURN MATERIAL AUTHORIZATION. SHOULD SUCH INSPECTION REVEAL, IN THE SELLER'S REASONABLE DISCRETION, THAT THE CLAIMED DEFECT IS NOT COVERED BY THIS WARRANTY, THE PARTY ASSERTING THIS WARRANTY SHALL PAY THE SELLER FOR THE TIME AND EXPENSES RELATED TO SUCH ON-SITE INSPECTION.

Exclusion of Consequential and Incidental Damages

IT IS SPECIFICALLY ACKNOWLEDGED THAT THIS WARRANTY, ANY OTHER EXPRESS WARRANTY NOT NEGATED HEREBY, AND ANY IMPLIED WARRANTY NOT NEGATED HEREBY, INCLUDING THE IMPLIED WARRANTIES OF MERCHANTABILITY AND FITNESS FOR A PARTICULAR PURPOSE, DO NOT COVER, AND NEITHER TLV, TII NOR ITS TLV GROUP COMPANIES WILL IN ANY EVENT BE LIABLE FOR, INCIDENTAL OR CONSEQUENTIAL DAMAGES, INCLUDING, BUT NOT LIMITED TO LOST PROFITS, THE COST OF DISASSEMBLY AND SHIPMENT OF THE DEFECTIVE PRODUCT, INJURY TO OTHER PROPERTY, DAMAGE TO BUYER'S OR THE FIRST END USER'S PRODUCT, DAMAGE TO BUYER'S OR THE FIRST END USER'S PROCESSES, LOSS OF USE, OR OTHER COMMERCIAL LOSSES. WHERE, DUE TO OPERATION OF LAW, CONSEQUENTIAL AND INCIDENTAL DAMAGES UNDER THIS WARRANTY, UNDER ANY OTHER EXPRESS WARRANTY NOT NEGATED HEREBY OR UNDER ANY IMPLIED WARRANTY NOT NEGATED HEREBY (INCLUDING THE IMPLIED WARRANTIES OF MERCHANTABILITY AND FITNESS FOR A PARTICULAR PURPOSE) CANNOT BE EXCLUDED, SUCH DAMAGES ARE EXPRESSLY LIMITED IN AMOUNT TO THE PURCHASE PRICE OF THE DEFECTIVE PRODUCT. THIS EXCLUSION OF CONSEQUENTIAL AND INCIDENTAL DAMAGES, AND THE PROVISION OF THIS WARRANTY LIMITING REMEDIES HEREUNDER TO REPLACEMENT, ARE INDEPENDENT PROVISIONS, AND ANY DETERMINATION THAT THE LIMITATION OF REMEDIES FAILS OF ITS ESSENTIAL PURPOSE OR ANY OTHER DETERMINATION THAT EITHER OF THE ABOVE REMEDIES IS UNENFORCEABLE, SHALL NOT BE CONSTRUED TO MAKE THE OTHER PROVISIONS UNENFORCEABLE.

Exclusion of Other Warranties

THIS WARRANTY IS IN LIEU OF ALL OTHER WARRANTIES, EXPRESS OR IMPLIED, AND ALL OTHER WARRANTIES, INCLUDING BUT NOT LIMITED TO THE IMPLIED WARRANTIES OF MERCHANTABILITY AND FITNESS FOR A PARTICULAR PURPOSE, ARE EXPRESSLY DISCLAIMED.

Severability

Any provision of this warranty which is invalid, prohibited or unenforceable in any jurisdiction shall, as to such jurisdiction, be ineffective to the extent of such invalidity, prohibition or unenforceability without invalidating the remaining provisions hereof, and any such invalidity, prohibition or unenforceability in any such jurisdiction shall not invalidate or render unenforceable such provision in any other jurisdiction.

Service

For Service or Technical Assistance: Contact your TLV representative or your regional TLV office.

In Europe:

TLV EURO ENGINEERING GmbH

Daimler-Benz-Straße 16-18, 74915 Waibstadt, **Germany**

Tel: [49]-(0)7263-9150-0

Fax: [49]-(0)7263-9150-50

TLV EURO ENGINEERING UK LTD.

Units 7 & 8, Furlong Business Park, Bishops Cleeve,
Gloucestershire GL52 8TW, **U.K.**

Tel: [44]-(0)1242-227223

Fax: [44]-(0)1242-223077

TLV EURO ENGINEERING FRANCE SARL

Parc d'Ariane 2, bât. C, 290 rue Ferdinand Perrier, 69800 Saint
Priest, **France**

Tel: [33]-(0)4-72482222

Fax: [33]-(0)4-72482220

In North America:

TLV CORPORATION

13901 South Lakes Drive, Charlotte, NC 28273-6790, **U.S.A.**

Tel: [1]-704-597-9070

Fax: [1]-704-583-1610

TLV ENGINEERING S. A. DE C.V.

Av. Jesús del Monte 39-B-1001, Col. Hda. de las Palmas,
Huixquilucan, Edo. de México, 52763, **Mexico**

Tel: [52]-55-5359-7949

Fax: [52]-55-5359-7585

In Oceania:

TLV PTY LIMITED

Unit 8, 137-145 Rooks Road, Nunawading, Victoria 3131,
Australia

Tel: [61]-(0)3-9873 5610

Fax: [61]-(0)3-9873 5010

In East Asia:

TLV PTE LTD

36 Kaki Bukit Place, #02-01/02, **Singapore** 416214

Tel: [65]-6747 4600

Fax: [65]-6742 0345

TLV SHANGHAI CO., LTD.

5/F, Building 7, No.103 Caobao Road, Xuhui District, Shanghai,
China 200233

Tel: [86]-(0)21-6482-8622

Fax: [86]-(0)21-6482-8623

TLV ENGINEERING SDN. BHD.

No.16, Jalan MJ14, Taman Industri Meranti Jaya, 47120 Puchong,
Selangor, **Malaysia**

Tel: [60]-3-8052-2928

Fax: [60]-3-8051-0899

TLV PRIVATE LIMITED

252/94 (K-L) 17th Floor, Muang Thai-Phatra Complex Tower B,
Rachadaphisek Road, Huaykwang, Bangkok 10310, **Thailand**

Tel: [66]-2-693-3799

Fax: [66]-2-693-3979

TLV INC.

#302-1 Bundang Technopark B, 723 Pangyo-ro, Bundang,
Seongnam, Gyeonggi, 13511, **Korea**

Tel: [82]-(0)31-726-2105

Fax: [82]-(0)31-726-2195

In the Middle East:

TLV ENGINEERING FZCO

Building 2W, No. M002, PO Box 371684, Dubai Airport Free Zone,
Dubai, **UAE**

Email: sales-me@tlv.co.jp

In Other Countries:

TLV INTERNATIONAL, INC.

881 Nagasuna, Noguchi, Kakogawa, Hyogo 675-8511, **Japan**

Tel: [81]-(0)79-427-1818

Fax: [81]-(0)79-425-1167

Manufacturer:

TLV CO., LTD.

881 Nagasuna, Noguchi, Kakogawa, Hyogo 675-8511, **Japan**

Tel: [81]-(0)79-427-1800

Fax: [81]-(0)79-422-2277

Options

The options shown below are available for this product on request. Please compare with the product you received.

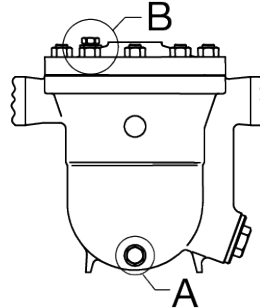

Options for Area A (standard: with drain plug)

Without Drain Plug

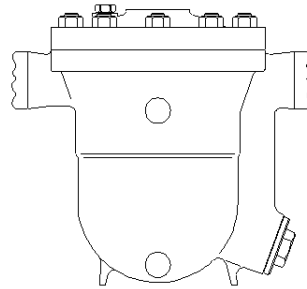

Options for Area B (standard: with cover plug)

A pressure-balancing line connector can be attached to the place where the standard product has the cover plug.

Socket Type (Model: JH7.5R-W)

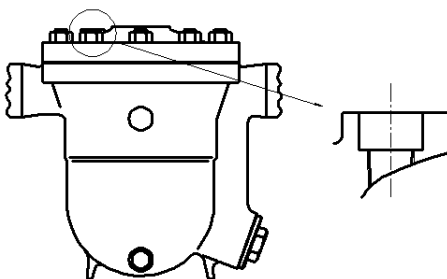

Flange Type (Model: JH7.5R-F)

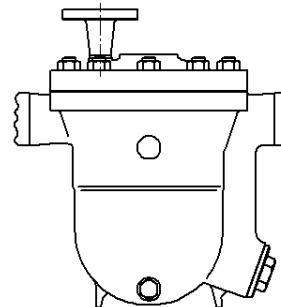

In principle, steam traps automatically discharge inflowing condensate. However, if low-temperature condensate in the piping blocks the trap inlet passage, displacement inside the piping of steam by condensate is obstructed and condensate can no longer flow into the trap (steam-locking). Traps only function in the presence of condensate inflow. A pressure-balancing line prevents the occurrence of steam-locking.

Install the pressure-balancing line in the following manner:

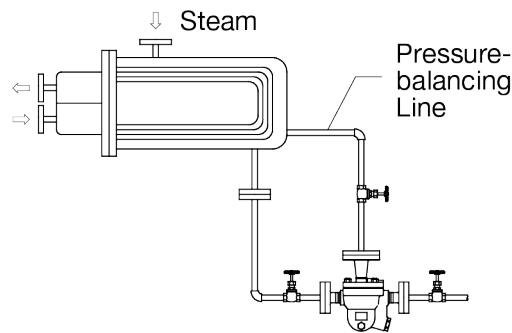

Attach the pressure-balancing line to the trap and to either the equipment or to an area with a steam space.

Options for Area B (standard: with plug)

Flange Type (Model: JH7.5R-V)

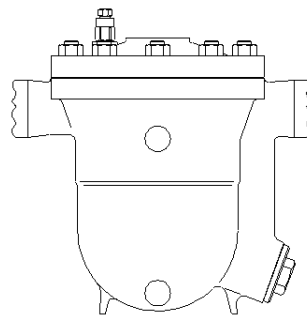

Operating the Air Vent Valve



Caution

Be sure to use only the recommended components when repairing the product, and NEVER attempt to modify the product in any way. Failure to observe these precautions may result in damage to the product and burns or other injury due to malfunction or the discharge of fluids.

Installation, inspection, maintenance, repairs, disassembly, adjustment and valve opening/closing should be carried out only by trained maintenance personnel.

1. Locate the air vent valve exhaust port before operating the air vent valve, and take care to avoid being burned by hot air or steam blowing from the vent. The exhaust port is a 2 mm ($1/16$ in) diameter hole on the side of the air vent valve body.

DO NOT under any circumstances allow any unprotected part of your body to come in front of this hole.

2. Never leave an open air vent valve unattended.

Tools required:

- Open-end wrench (distance across flats 17 mm ($21/32$ in))
- Long-handled mirror to check for steam leakage after closing the exhaust port (leaking steam cloud the mirror)

Using the open-end wrench, slowly turn the hexagonal head of the valve stem counterclockwise.

Watch the exhaust port to determine the condition of the fluid discharged. General guidelines:

- Cloudy: Water droplets and mist spraying out, indicating that air and condensate are being discharged
- Clear: Indicating that steam is being discharged; the valve port may now be closed

**Caution**

The air vent valve stem cannot be removed from the air vent valve body. Attempting to remove the valve stem by pulling it upward may damage it and cause burns or other injury due to malfunction or the discharge of steam or condensate.

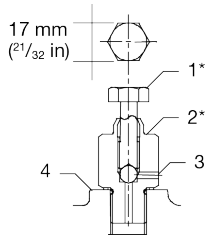

1	Air Vent Valve Stem
2	Air Vent Valve Body
3	Exhaust Port
4	Cover

3. Use the following procedure to close the valve and check for leaks:
 Using the open-end wrench, close by slowly turning the hexagonal head of the valve stem clockwise until contact with the valve seat is felt.
 Apply a little more pressure to tighten securely.

**Note**

Using an ordinary open-end wrench (handle length about 160 mm (6¹/₄ in)), the valve will close with only a light turn pressure. Tightening with too much force may result in seizure or damage to the seat.

After tightening, place the mirror close to the front of the exhaust port. If the mirror clouds, the valve is not fully closed; tighten a bit more.

4. When air enters the piping at start-up, it may accumulate inside the trap and hinder the flow of condensate (air binding). Air binding may also occur during the normal course of trap operation, due to the slow accumulation of air inside the trap. The air vent valve on the top of this trap is to be operated only when air binding has occurred. Follow the instructions in the earlier part of this section to operate the air vent valve and release the air accumulated inside the trap. (The air vent valve is to be open only for as long as is necessary to release the accumulated air. If left open, it is extremely dangerous, so be sure to close tightly after operation.)

Disassembly/Reassembly of Air Vent Valve

Part Name & No.	During Disassembly	During Reassembly
Air Vent Valve Unit	Remove with a socket wrench	Consult the table of tightening torques and tighten to the proper torque
Air Vent Valve Gasket	Remove the gasket and clean sealing surfaces	Replace with a new gasket; coat surfaces with anti-seize

Table of Tightening Torques

Part Name & No.	Torque N·m	Distance Across Flats mm
Air Vent Valve Body	100	24

**Note**

- Coat all threaded portions and valve seat gasket with anti-seize.
- If drawings or other special documentation were supplied for the product, any torque given there takes precedence over values shown here.