

ISO 9001
ISO14001



Manufacturer

TLV CO., LTD.

Kakogawa, Japan

is approved by LRQA Ltd. to ISO 9001:2001



Instruction Manual

Automatic Air Vent

Featured Model: VS1C-M2

172-65871M-00

Publication date 6 April 2026

Copyright © 2026 TLV CO., LTD.

Table of Contents

Introduction	3
Safety Considerations	4
Features	6
Operation	7
Specifications	8
Configuration	9
Installation	10
Maintenance	12
Disassembly/Reassembly	13
Troubleshooting	15
TLV EXPRESS LIMITED WARRANTY	16
Service	18

Introduction

Thank you for purchasing the TLV automatic air vent.

This product has been thoroughly inspected before being shipped from the factory. When the product is delivered, before doing anything else, check the specifications and external appearance to make sure nothing is out of the ordinary. Also be sure to read this manual carefully before use and follow the instructions to be sure of using the product properly.

The automatic air vent is designed to automatically discharge/release air trapped in water-carrying pipes during water transport. It also automatically discharges the air that was entrained in the water during operation and has subsequently been separated and collected in specific locations in the piping.

If detailed instructions for special order specifications or options not contained in this manual are required, please contact TLV for full details.

This instruction manual is intended for use with the model(s) listed on the front cover. It is necessary not only for installation but for subsequent maintenance, disassembly/reassembly and troubleshooting. Please keep it in a safe place for future reference.

Safety Considerations

- Read this section carefully before use and be sure to follow the instructions.
- Installation, inspection, maintenance, repairs, disassembly, adjustment and valve opening/closing should be carried out only by trained maintenance personnel.
- The precautions listed in this manual are designed to ensure safety and prevent equipment damage and personal injury. For situations that may occur as a result of erroneous handling, three different types of cautionary items are used to indicate the degree of urgency and the scale of potential damage and danger: DANGER, WARNING and CAUTION.
- The three types of cautionary items above are very important for safety: be sure to observe all of them as they relate to installation, use, maintenance and repair. Furthermore, TLV accepts no responsibility for any accidents or damage occurring as a result of failure to observe these precautions.

Cautionary items and definitions



Danger

Indicates an urgent situation which poses a threat of death or serious injury



Warning

Indicates that there is a potential threat of death or serious injury



Caution

Indicates that there is a possibility of injury or equipment/product damage

Safety Considerations for the Product



Warning

DO NOT use for toxic, flammable or otherwise hazardous fluids. This product is an air vent that discharges air from water piping system. Use only for water and/or air. This product is for intended use only. Improper use may result in such hazards as damage to the product or malfunctions that may lead to serious accidents.



Warning

NEVER apply direct heat to the float. The float may explode due to increased internal pressure, causing accidents leading to serious injury or damage to property and equipment.



Caution

Install properly and DO NOT use this product outside the recommended operating pressure, temperature and other specification ranges. Improper use may result in such hazards as damage to the product or malfunctions that may lead to serious accidents. Local regulations may restrict the use of this product to below the conditions quoted.



Caution

DO NOT use this product in excess of the maximum operating pressure differential. Such use could make discharge impossible (blocked).



Caution

Take measures to prevent people from coming into direct contact with product outlets. Failure to do so may result in burns or other injury from the discharge of fluids.

**Caution**

When disassembling or removing the product, wait until the internal pressure equals atmospheric pressure and the surface of the product has cooled to room temperature. Disassembling or removing the product when it is hot or under pressure may lead to discharge of fluids, causing burns, other injuries or damage.

**Caution**

Be sure to use only the recommended components when repairing the product, and NEVER attempt to modify the product in any way. Failure to observe these precautions may result in damage to the product and burns or other injury due to malfunction or the discharge of fluids.

**Caution**

Use only under conditions in which no freeze-up will occur. Freezing may damage the product, leading to fluid discharge, which may cause burns or other injury.

**Caution**

Use only under conditions in which no water hammer will occur. The impact of water hammer may damage the product, leading to fluid discharge, which may cause burns or other injury.

Features

1. Precision-ground float and three-point seating provide the tightest seal.
2. All stainless steel construction provides outstanding corrosion resistance.
3. The air vent has no hinges or levers: the only moving part is the precision-ground float, which eliminates concentrated wear and provides long service life.
4. Simple construction with few parts allows for easy maintenance.
5. The air vent is small and light.

Operation



Caution

Take measures to prevent people from coming into direct contact with product outlets. Failure to do so may result in burns or other injury from the discharge of fluids.

1. When water is transported, air inside the piping is forced into the air vent by the pressure of the flow. The float inside the air vent is in the lower position, thus the valve is fully open and allows the air that enters the air vent and fills the area around the float to then be discharged.

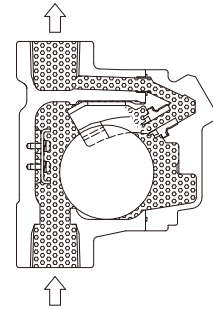

2. When discharge is completed, as water flows into the air vent, the rising water level causes the float to rise and to close the valve. If there is a rapid rise in water level (caused by rapidly opening a shut-off valve, etc.), a small amount of water may leak with discharged air immediately before the air vent closes.

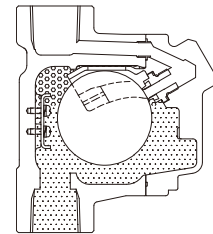

3. If air enters the air vent while the water is causing the valve to be closed, the air causes the water level to drop, thus the float loses buoyancy and the valve opens. After the air is discharged, the water level once again rises and the valve again becomes closed. In this manner, the air vent constantly responds to the amount of water flow by automatically adjusting discharge.

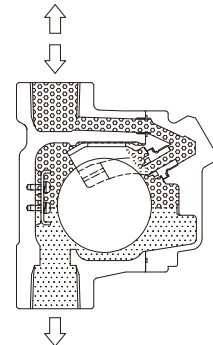

4. When draining the piping, the air vent automatically opens to introduce air and remove water more easily (preventing a vacuum from forming in the piping).



Specifications



Warning

DO NOT use for toxic, flammable or otherwise hazardous fluids. This product is an air vent that discharges air from water piping system. Use only for water and/or air. This product is for intended use only. Improper use may result in such hazards as damage to the product or malfunctions that may lead to serious accidents.



Caution

Install properly and DO NOT use this product outside the recommended operating pressure, temperature and other specification ranges. Improper use may result in such hazards as damage to the product or malfunctions that may lead to serious accidents. Local regulations may restrict the use of this product to below the conditions quoted.

DO NOT use this product in excess of the maximum operating pressure differential. Such use could make discharge impossible (blocked).

Use only under conditions in which no water hammer will occur. The impact of water hammer may damage the product, leading to fluid discharge, which may cause burns or other injury.

Refer to the product nameplate for detailed specifications.

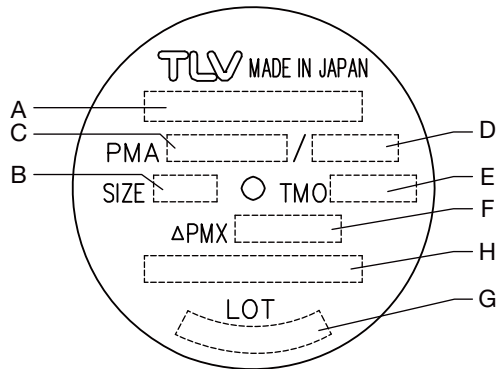

A	Model	E	Maximum Operating Temperature (TMO)
B	Nominal Diameter	F	Maximum Differential Pressure (PMX) ⁰¹
C	Maximum Allowable Pressure (PMA) ⁰²	G	Production Lot No.
D	Maximum Allowable Temperature (TMA) ⁰²	H	Valve No. ⁰³

⁰¹This is applicable only during the initial discharge of air. Once the valve closes, it will remain closed even if the differential pressure is within this range.

⁰²Maximum allowable pressure (PMA) and maximum allowable temperature (TMA) are PRESSURE SHELL DESIGN CONDITIONS, **NOT** OPERATING CONDITIONS.

⁰³Valve No. is displayed for products with options. This item is omitted from the nameplate when there are no options.

Configuration

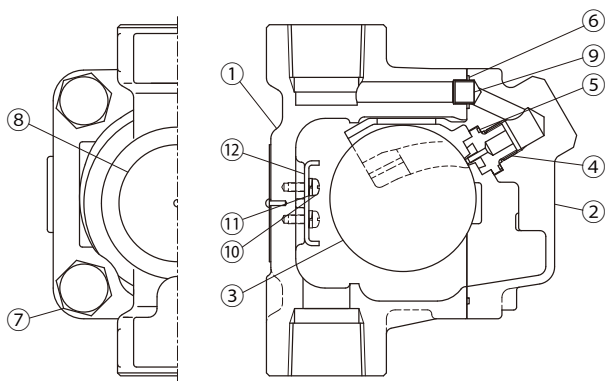

No.	Part Name	No.	Part Name
1	Body	7	Cover Bolt
2	Cover	8	Nameplate
3	Float	9	Connector
4	Valve Seat	10	Screw
5	Valve Seat Gasket	11	Spring Washer
6	Cover Gasket	12	Guide Plate

Installation



Warning

DO NOT use for toxic, flammable or otherwise hazardous fluids. This product is an air vent that discharges air from water piping system. Use only for water and/or air. This product is for intended use only. Improper use may result in such hazards as damage to the product or malfunctions that may lead to serious accidents.



Caution

Install properly and DO NOT use this product outside the recommended operating pressure, temperature and other specification ranges. Improper use may result in such hazards as damage to the product or malfunctions that may lead to serious accidents. Local regulations may restrict the use of this product to below the conditions quoted.

Take measures to prevent people from coming into direct contact with product outlets. Failure to do so may result in burns or other injury from the discharge of fluids.

Installation, inspection, maintenance, repairs, disassembly, adjustment and valve opening/closing should be carried out only by trained maintenance personnel.

1. Before installation, be sure to remove all protective seals from the product.
2. Before installing the product, open the inlet valve and blow out the piping to remove any piping scraps, dirt and oil. Close the inlet valve after blowdown.
3. This product must be installed vertically, with the inlet at the bottom and the outlet at the top, and should be inclined no more than 5° horizontally and front-to-back.
4. Install the product in a location where air is likely to collect, such as a bend in the piping.
5. Install the product so that the outlet pipe reaches a drainage vessel or ditch. Make sure the end of the pipe is above the waterline (as shown in the figure below), so that dirt and water cannot be sucked up by vacuum when the system shuts down.
6. Inlet piping with no horizontal portion is recommended for water/air displacement. If there is a horizontal portion, make the pipe diameter of the horizontal portion larger than the vertical portion or make the horizontal portion as short as possible.
7. Make sure the inlet piping diameter is at least as large as the product's inlet diameter. For the inlet connection especially for the products with a nominal diameter of 15 mm, use a pipe/fitting, etc. with an inner diameter of at least 16 mm, such as a schedule 40 pipe nipple with a nominal diameter of 15 mm. A smaller pipe may prevent water/air displacement. For example, Schedule 40 STPG370 pipe with a nominal diameter of 15 mm is suitable.
8. Installation of an isolation valve just before the product's main connection is recommended as it enables maintenance during operation. A full-bore ball valve is recommended.
9. Make sure to take measures to prevent foreign matter from flowing into the product.

If there is a problem, determine the cause using the "Troubleshooting" section in this manual.

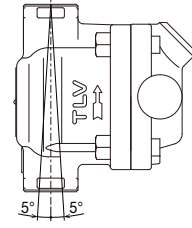
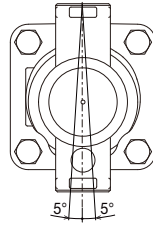
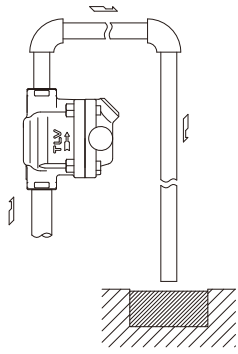

Maintenance



Caution

Take measures to prevent people from coming into direct contact with product outlets. Failure to do so may result in burns or other injury from the discharge of fluids.

Be sure to use only the recommended components when repairing the product, and NEVER attempt to modify the product in any way. Failure to observe these precautions may result in damage to the product and burns or other injury due to malfunction or the discharge of fluids.

Operational Check

A visual inspection of the following items should be done on a daily basis to determine whether the product is operating properly or has failed.

If the product should fail, it may cause water leakage or hindrance to water flow.

Normal: Air is discharged as it accumulates, with the product closing (with no leakage) when no air is present in the piping.

Blocked (Discharge Impossible): No air is discharged though air accumulates in the product.

Leakage: Water is discharged or leaks through the product outlet during closed position.

Parts Inspection

When parts have been removed, or during periodic inspections, use the following table to inspect the parts and replace any that are found to be defective.

Gasket(s): Check for warping and damage

Valve Seat: Check for scratches or wear

Float: Check for scratches or dents

Guide Plate: Check for damage

Disassembly/Reassembly



Warning

NEVER apply direct heat to the float. The float may explode due to increased internal pressure, causing accidents leading to serious injury or damage to property and equipment.



Caution

When disassembling or removing the product, wait until the internal pressure equals atmospheric pressure and the surface of the product has cooled to room temperature. Disassembling or removing the product when it is hot or under pressure may lead to discharge of fluids, causing burns, other injuries or damage.

Be sure to use only the recommended components when repairing the product, and NEVER attempt to modify the product in any way. Failure to observe these precautions may result in damage to the product and burns or other injury due to malfunction or the discharge of fluids.

Use the following procedures to remove components. Use the same procedures in reverse to reassemble. (Installation, inspection, maintenance, repairs, disassembly, adjustment and valve opening/closing should be carried out only by trained maintenance personnel.)

Detaching/Reattaching the Cover and its Components

Part Name & No.		During Disassembly	During Reassembly
Cover Bolt	7	Remove with a socket wrench	Consult the table of tightening torques and tighten to the proper torque
Cover	2	Remove, being careful not to damage the float, which may fall out when the cover is removed	Make sure the sealing surfaces are clean, then reattach; be careful not to bend the float guides
Float	3	Remove, being careful not to scratch the polished surface	Insert, being careful not to scratch the polished surface.
Connector	9	Remove the connector	Reinsert into the hole in the cover
Cover Gasket	6	Remove if damaged	Replace with a new gasket if warped or damaged; for safety, replace with a new gasket once a year
Valve Seat	4	Remove with a socket wrench	Replace with a new valve seat if misshapen or damaged; consult the table of tightening torques and tighten to the proper torque
Valve Seat Gasket	5	Remove the gasket and clean sealing surfaces	Replace with a new gasket if warped or damaged; for safety, replace with a new gasket once a year

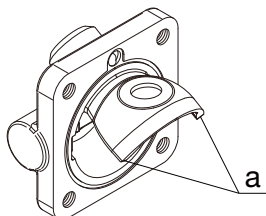

Note

The float guides (a) are correctly positioned when shipped from the factory, so be careful when handling them. Tight sealing cannot be guaranteed if the float guides have been moved out of position.

Body Interior Plate (Part No. 12)

The guide plate built into the body with screws (and spring washer) does not require removal during normal product disassembly. The plate should only be replaced when it has become deformed or damaged. Upon reassembly, tighten to the proper torque.

Table of Tightening Torques

Part Name & No.		Torque N·m	Distance Across Flats mm
Cover Bolt	7	45	16
Valve Seat	4	15	13
Screw (for Guide Plate)	10	0.3	+



Note

- Coat all threaded portions with anti-seize.
- If drawings or other special documentation were supplied for the product, any torque given there takes precedence over values shown here.

Exploded View

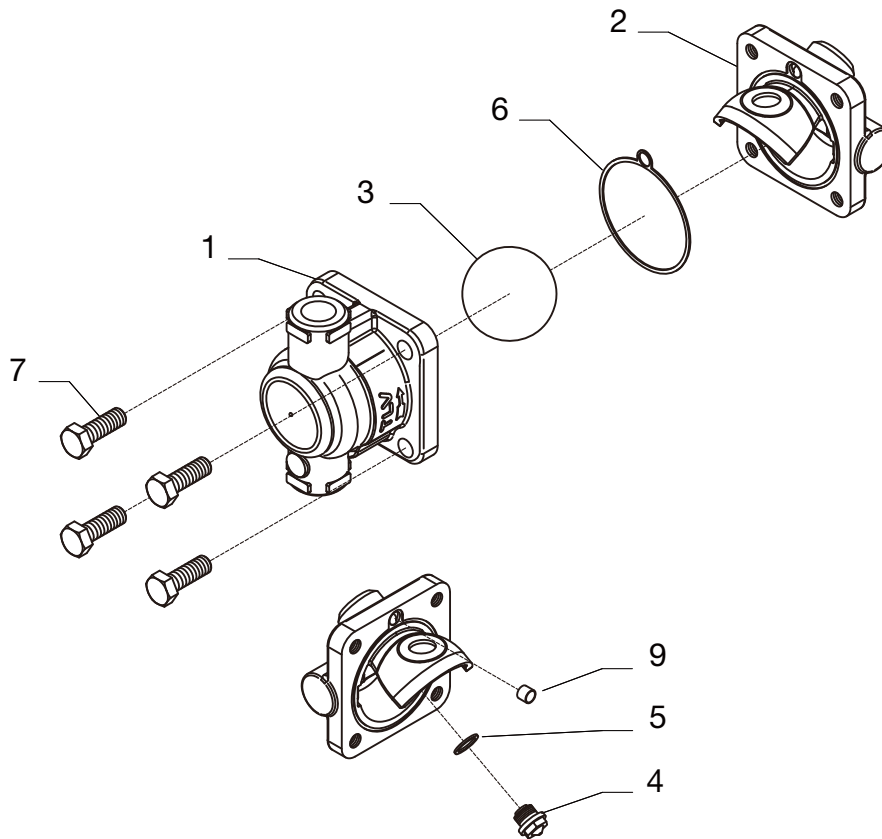

No.	Part Name	No.	Part Name
1	Body	7	Cover Bolt
2	Cover	8	Nameplate ⁰¹
3	Float	9	Connector
4	Valve Seat	10	Screw ⁰¹
5	Valve Seat Gasket	11	Spring Washer ⁰¹
6	Cover Gasket	12	Guide Plate ⁰¹

⁰¹Not shown

Troubleshooting



Warning

NEVER apply direct heat to the float. The float may explode due to increased internal pressure, causing accidents leading to serious injury or damage to property and equipment.



Caution

When disassembling or removing the product, wait until the internal pressure equals atmospheric pressure and the surface of the product has cooled to room temperature. Disassembling or removing the product when it is hot or under pressure may lead to discharge of fluids, causing burns, other injuries or damage.

When the product fails to operate properly, use the following table to locate the cause and remedy.

Problem	Cause	Remedy
No air is discharged (blocked) or discharge is poor ⁰¹	The trapped air cannot displace the water in the piping	Correct the inlet piping (Inner diameter should be at least 16 mm)
	The valve seat is clogged with dirt or foreign matter	Clean the valve seat
	The inlet or outlet piping is clogged	Clean the piping
	Operating pressure exceeds the rated maximum operating pressure	Replace with a product of suitable operating pressure
Water leaks when the valve is closed	There is a build-up of rust or scale on the valve seat or the valve seat is damaged	Clean or replace with a new valve seat
	The float is misshapen, dirty or has a film build-up	Clean or replace with a new float
	Improper installation orientation	Correct the installation
The vent does not close and water is blowing	The float is damaged or filled with water	Replace with a new float
	The specific gravity of the liquid is not suitable for this product (This product is for water systems)	Select a product with suitable specifications for the operating conditions

⁰¹Once the air vent closes, it will remain closed until internal pressure drops to near or below atmospheric pressure. This condition may be confused with a malfunction blocked). If air is expected to accumulate in the piping during operation, use together with an automatic air vent.

TLV EXPRESS LIMITED WARRANTY

Subject to the limitations set forth below, TLV CO., LTD., a Japanese corporation ("**TLV**"), warrants that products which are sold by it, TLV International Inc. ("**TII**") or one of its group companies excluding TLV Corporation (a corporation of the United States of America), (hereinafter the "**Products**") are designed and manufactured by TLV, conform to the specifications published by TLV for the corresponding part numbers (the "**Specifications**") and are free from defective workmanship and materials. The party from whom the Products were purchased shall be known hereinafter as the "**Seller**". With regard to products or components manufactured by unrelated third parties (the "**Components**"), TLV provides no warranty other than the warranty from the third party manufacturer(s), if any.

Exceptions to Warranty

This warranty does not cover defects or failures caused by:

1. improper shipping, installation, use, handling, etc., by persons other than TLV, TII or TLV group company personnel, or service representatives authorized by TLV; or
2. dirt, scale or rust, etc.; or
3. improper disassembly and reassembly, or inadequate inspection and maintenance by persons other than TLV or TLV group company personnel, or service representatives authorized by TLV; or
4. disasters or forces of nature or Acts of God; or
5. abuse, abnormal use, accidents or any other cause beyond the control of TLV, TII or TLV group companies; or
6. improper storage, maintenance or repair; or
7. operation of the Products not in accordance with instructions issued with the Products or with accepted industry practices; or
8. use for a purpose or in a manner for which the Products were not intended; or
9. use of the Products in a manner inconsistent with the Specifications; or
10. use of the Products with Hazardous Fluids (fluids other than steam, air, water, nitrogen, carbon dioxide and inert gases (helium, neon, argon, krypton, xenon and radon)); or
11. failure to follow the instructions contained in the TLV Instruction Manual for the Product.

Duration of Warranty

This warranty is effective for a period of one (1) year after delivery of Products to the first end user. Notwithstanding the foregoing, asserting a claim under this warranty must be brought within three (3) years after the date of delivery to the initial buyer if not sold initially to the first end user.

ANY IMPLIED WARRANTIES NOT NEGATED HEREBY WHICH MAY ARISE BY OPERATION OF LAW, INCLUDING THE IMPLIED WARRANTIES OF MERCHANTABILITY AND FITNESS FOR A PARTICULAR PURPOSE AND ANY EXPRESS WARRANTIES NOT NEGATED HEREBY, ARE GIVEN SOLELY TO THE INITIAL BUYER AND ARE LIMITED IN DURATION TO ONE (1) YEAR FROM THE DATE OF SHIPMENT BY THE SELLER.

Exclusive Remedy

THE EXCLUSIVE REMEDY UNDER THIS WARRANTY, UNDER ANY EXPRESS WARRANTY OR UNDER ANY IMPLIED WARRANTIES NOT NEGATED HEREBY (INCLUDING THE IMPLIED WARRANTIES OF MERCHANTABILITY AND FITNESS FOR A PARTICULAR PURPOSE), IS **REPLACEMENT**; PROVIDED: (a) THE CLAIMED DEFECT IS

REPORTED TO THE SELLER IN WRITING WITHIN THE WARRANTY PERIOD, INCLUDING A DETAILED WRITTEN DESCRIPTION OF THE CLAIMED DEFECT AND HOW AND WHEN THE CLAIMED DEFECTIVE PRODUCT WAS USED; AND (b) THE CLAIMED DEFECTIVE PRODUCT AND A COPY OF THE PURCHASE INVOICE IS RETURNED TO THE SELLER, FREIGHT AND TRANSPORTATION COSTS PREPAID, UNDER A RETURN MATERIAL AUTHORIZATION AND TRACKING NUMBER ISSUED BY THE SELLER. ALL LABOR COSTS, SHIPPING COSTS, AND TRANSPORTATION COSTS ASSOCIATED WITH THE RETURN OR REPLACEMENT OF THE CLAIMED DEFECTIVE PRODUCT ARE SOLELY THE RESPONSIBILITY OF BUYER OR THE FIRST END USER. THE SELLER RESERVES THE RIGHT TO INSPECT ON THE FIRST END USER'S SITE ANY PRODUCTS CLAIMED TO BE DEFECTIVE BEFORE ISSUING A RETURN MATERIAL AUTHORIZATION. SHOULD SUCH INSPECTION REVEAL, IN THE SELLER'S REASONABLE DISCRETION, THAT THE CLAIMED DEFECT IS NOT COVERED BY THIS WARRANTY, THE PARTY ASSERTING THIS WARRANTY SHALL PAY THE SELLER FOR THE TIME AND EXPENSES RELATED TO SUCH ON-SITE INSPECTION.

Exclusion of Consequential and Incidental Damages

IT IS SPECIFICALLY ACKNOWLEDGED THAT THIS WARRANTY, ANY OTHER EXPRESS WARRANTY NOT NEGATED HEREBY, AND ANY IMPLIED WARRANTY NOT NEGATED HEREBY, INCLUDING THE IMPLIED WARRANTIES OF MERCHANTABILITY AND FITNESS FOR A PARTICULAR PURPOSE, DO NOT COVER, AND NEITHER TLV, TII NOR ITS TLV GROUP COMPANIES WILL IN ANY EVENT BE LIABLE FOR, INCIDENTAL OR CONSEQUENTIAL DAMAGES, INCLUDING, BUT NOT LIMITED TO LOST PROFITS, THE COST OF DISASSEMBLY AND SHIPMENT OF THE DEFECTIVE PRODUCT, INJURY TO OTHER PROPERTY, DAMAGE TO BUYER'S OR THE FIRST END USER'S PRODUCT, DAMAGE TO BUYER'S OR THE FIRST END USER'S PROCESSES, LOSS OF USE, OR OTHER COMMERCIAL LOSSES. WHERE, DUE TO OPERATION OF LAW, CONSEQUENTIAL AND INCIDENTAL DAMAGES UNDER THIS WARRANTY, UNDER ANY OTHER EXPRESS WARRANTY NOT NEGATED HEREBY OR UNDER ANY IMPLIED WARRANTY NOT NEGATED HEREBY (INCLUDING THE IMPLIED WARRANTIES OF MERCHANTABILITY AND FITNESS FOR A PARTICULAR PURPOSE) CANNOT BE EXCLUDED, SUCH DAMAGES ARE EXPRESSLY LIMITED IN AMOUNT TO THE PURCHASE PRICE OF THE DEFECTIVE PRODUCT. THIS EXCLUSION OF CONSEQUENTIAL AND INCIDENTAL DAMAGES, AND THE PROVISION OF THIS WARRANTY LIMITING REMEDIES HEREUNDER TO REPLACEMENT, ARE INDEPENDENT PROVISIONS, AND ANY DETERMINATION THAT THE LIMITATION OF REMEDIES FAILS OF ITS ESSENTIAL PURPOSE OR ANY OTHER DETERMINATION THAT EITHER OF THE ABOVE REMEDIES IS UNENFORCEABLE, SHALL NOT BE CONSTRUED TO MAKE THE OTHER PROVISIONS UNENFORCEABLE.

Exclusion of Other Warranties

THIS WARRANTY IS IN LIEU OF ALL OTHER WARRANTIES, EXPRESS OR IMPLIED, AND ALL OTHER WARRANTIES, INCLUDING BUT NOT LIMITED TO THE IMPLIED WARRANTIES OF MERCHANTABILITY AND FITNESS FOR A PARTICULAR PURPOSE, ARE EXPRESSLY DISCLAIMED.

Severability

Any provision of this warranty which is invalid, prohibited or unenforceable in any jurisdiction shall, as to such jurisdiction, be ineffective to the extent of such invalidity, prohibition or unenforceability without invalidating the remaining provisions hereof, and any such invalidity, prohibition or unenforceability in any such jurisdiction shall not invalidate or render unenforceable such provision in any other jurisdiction.

Service

For Service or Technical Assistance: Contact your TLV representative or your regional TLV office.

In Europe:

TLV EURO ENGINEERING GmbH

Daimler-Benz-Straße 16-18, 74915 Waibstadt, **Germany**

Tel: [49]-(0)7263-9150-0

TLV EURO ENGINEERING UK LTD.

Units 7 & 8, Furlong Business Park, Bishops Cleeve,
Gloucestershire GL52 8TW, **U.K.**

Tel: [44]-(0)1242-227223

TLV EURO ENGINEERING FRANCE SARL

Parc d'Ariane 2, bât. C, 290 rue Ferdinand Perrier, 69800 Saint
Priest, **France**

Tel: [33]-(0)4-72482222

Fax: [33]-(0)4-72482220

In North America:

TLV CORPORATION

13901 South Lakes Drive, Charlotte, NC 28273-6790, **U.S.A.**

Tel: [1]-704-597-9070

Fax: [1]-704-583-1610

TLV ENGINEERING S. A. DE C. V.

Av. Jesús del Monte 39-B-1001, Col. Hda. de las Palmas,
Huixquilucan, Edo. de México, 52763, **Mexico**

Tel: [52]-55-5359-7949

Fax: [52]-55-5359-7585

In Oceania:

TLV PTY LIMITED

Unit 8, 137-145 Rooks Road, Nunawading, Victoria 3131,

Tel: [61]-(0)3-9873 5610

Fax: [61]-(0)3-9873 5010

Australia

In East Asia:

TLV PTE LTD

36 Kaki Bukit Place, #02-01/02, **Singapore** 416214

Tel: [65]-6747 4600

Fax: [65]-6742 0345

TLV SHANGHAI CO., LTD.

5/F, Building 7, No.103 Caobao Road, Xuhui District, Shanghai,
China 200233

Tel: [86]-(0)21-6482-8622

Fax: [86]-(0)21-6482-8623

TLV ENGINEERING SDN. BHD.

No.16, Jalan MJ14, Taman Industri Meranti Jaya, 47120 Puchong,
Selangor, **Malaysia**

Tel: [60]-3-8052-2928

Fax: [60]-3-8051-0899

TLV PRIVATE LIMITED

252/94 (K-L) 17th Floor, Muang Thai-Phatra Complex Tower B,
Rachadaphisek Road, Huaykwang, Bangkok 10310, **Thailand**

Tel: [66]-2-693-3799

Fax: [66]-2-693-3979

TLV INC.

#1121, Seongnam Central Biz Tower 3, 208, Galmachi-ro,
Jungwon-gu, Seongnam-si, Gyeonggi-do, 13216, **Korea**

Tel: [82]-(0)31-726-2105

Fax: [82]-(0)31-726-2195

In the Middle East:

TLV ENGINEERING FZCO

Building 9W, B163, PO Box 371684, Dubai Airport Free Zone,
Dubai, **UAE**

Email: sales-me@tlv.co.jp

In Other Countries:

TLV INTERNATIONAL, INC.

881 Nagasuna, Noguchi, Kakogawa, Hyogo 675-8511, **Japan**

Tel: [81]-(0)79-427-1818

Fax: [81]-(0)79-425-1167

Manufacturer:

TLV CO., LTD.

881 Nagasuna, Noguchi, Kakogawa, Hyogo 675-8511, **Japan**

Tel: [81]-(0)79-427-1800

Fax: [81]-(0)79-422-2277