

# INSTRUCTION MANUAL

Keep this manual in a safe place for future reference

## TLV® FREE FLOAT STEAM TRAPS SS1NL/SS1NH/SS1VL/SS1VH

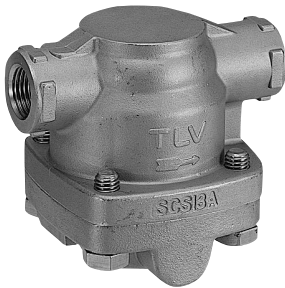

SS1NL/SS1NH



SS1VL/SS1VH

Manufacturer

**TLV® CO., LTD.**

881 Nagasuna, Noguchi, Kakogawa, Hyogo 675-8511, Japan

Tel: [81]-(0)79-427-1800 Fax: [81]-(0)79-422-2277

Copyright (C) 2023 by TLV CO., LTD. All rights reserved.

**EAC**



# Introduction

Before beginning installation or maintenance, please read this manual to ensure correct use of the product. Keep the manual in a safe place for future reference.

The all stainless steel Free Float steam traps of the SS1 series, with bimetal thermostatic air vent, are suitable for a wide range of small to medium capacity applications up to 2.1 MPaG (300 psig), such as steam mains, tracer lines, small process applications, etc. The traps discharge condensate continuously and automatically, at a temperature slightly lower than saturation temperature.

1 MPa = 10.197 kg/cm<sup>2</sup>, 1 bar = 0.1 MPa



For products with special specifications or with options not included in this manual, contact TLV for instructions.

The contents of this manual are subject to change without notice.

## 1. Safety Considerations

- Read this section carefully before use and be sure to follow the instructions.
- Installation, inspection, maintenance, repairs, disassembly, adjustment and valve opening/closing should be carried out only by trained maintenance personnel.
- The precautions listed in this manual are designed to ensure safety and prevent equipment damage and personal injury. For situations that may occur as a result of erroneous handling, three different types of cautionary items are used to indicate the degree of urgency and the scale of potential damage and danger: DANGER, WARNING and CAUTION.
- The three types of cautionary items above are very important for safety; be sure to observe all of them, as they relate to installation, use, maintenance, and repair. Furthermore, TLV accepts no responsibility for any accidents or damage occurring as a result of failure to observe these precautions.

 <b>DANGER</b>	 <b>WARNING</b>	 <b>CAUTION</b>
Indicates an urgent situation which poses a threat of death or serious injury.	Indicates that there is a potential threat of death or serious injury.	Indicates that there is a possibility of injury or equipment/product damage.

 <b>WARNING</b>	<b>NEVER apply direct heat to the float.</b> The float may explode due to increased internal pressure, causing accidents leading to serious injury or damage to property and equipment.
 <b>CAUTION</b>	<b>Install properly and DO NOT use this product outside the recommended operating pressure, temperature and other specification ranges.</b> Improper use may result in such hazards as damage to the product or malfunctions, which may lead to serious accidents. Local regulations may restrict the use of this product to below the conditions quoted.
	<b>DO NOT use this product in excess of the maximum operating pressure differential.</b> Such use could make discharge impossible.
	<b>Do not subject this product to condensate loads that exceed its discharge capacity.</b> Failure to observe this precaution may lead to condensate accumulation upstream of the trap, resulting in reduced equipment performance or damage to the equipment.
	<b>Take measures to prevent people from coming into direct contact with product outlets.</b> Failure to do so may result in burns or other injury from the discharge of fluids.

Continued on the next page

 <b>CAUTION</b>	<p><b>When disassembling or removing the product, wait until the internal pressure equals atmospheric pressure and the surface of the product has cooled to room temperature.</b> Disassembling or removing the product when it is hot or under pressure may lead to discharge of fluids, causing burns, other injuries or damage.</p>
	<p><b>Be sure to use only the recommended components when repairing the product, and NEVER attempt to modify the product in any way.</b> Failure to observe these precautions may result in damage to the product or burns or other injury due to malfunction or the discharge of fluids.</p>
	<p><b>Use only under conditions in which no freeze-up will occur.</b> Freezing may damage the product, leading to fluid discharge, which may cause burns or other injury.</p>
	<p><b>Use under conditions in which no water hammer will occur.</b> The impact of water hammer may damage the product, leading to fluid discharge, which may cause burns or other injury.</p>

## 2. Specifications

Refer to the product nameplate for detailed specifications.

- A Model
- B Nominal Diameter
- C Maximum Allowable Pressure\*
- D Maximum Allowable Temperature\* TMA
- E Maximum Differential Pressure
- F Maximum Operating Temperature
- G Production Lot No.
- H Valve No.\*\*

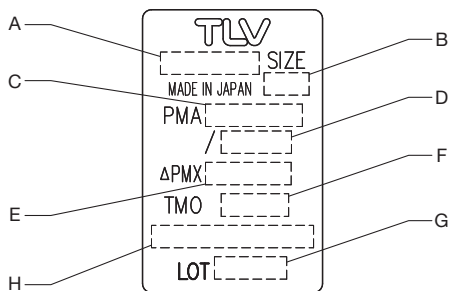
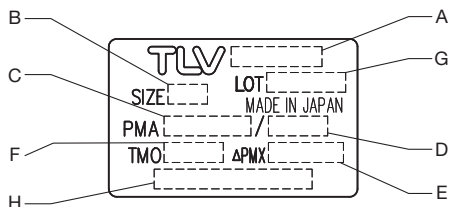

\* Maximum allowable pressure (PMA) and maximum allowable temperature (TMA) are PRESSURE SHELL DESIGN CONDITIONS, **NOT** OPERATING CONDITIONS.

\*\* "Valve No." is displayed for products with options. This item is omitted from the nameplate when there are no options.



To avoid malfunctions, product damage, accidents or serious injury, install properly and DO NOT use this product outside the specification range. Local regulations may restrict the use of this product to below the conditions quoted.

### 3. Configuration

#### SS1NL/SS1NH

Horizontal

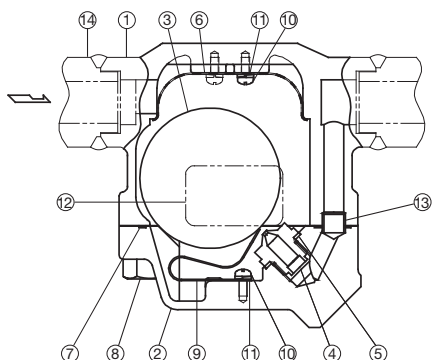

#### SS1VL/SS1VH

Vertical

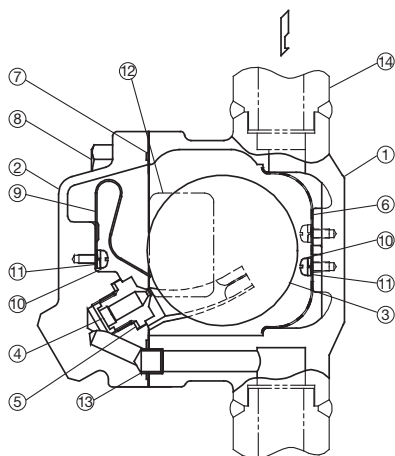

No.	Description	M*	R*	F*	No.	Description	M*	R*	F*
1	Body	-	-	-	8	Cover Bolt	-	-	-
2	Cover**	-	-	-	9	Bimetal Air Vent Strip	-	✓	-
3	Float	-	-	✓	10	Screw	-	✓	-
4	Orifice	-	✓	-	11	Spring Washer	-	✓	-
5	Orifice Gasket	✓	✓	-	12	Nameplate	-	-	-
6	Screen	-	✓	-	13	Connector	-	-	-
7	Cover Gasket	✓	✓	-	14	Pipe/Flange	-	-	-

\* M = Maintenance Kit; R = Repair Kit; F = Float; replacement parts are available only in their respective kits

\*\* Includes attached float guides for SS1VL/SS1VH

# 4. Exploded View

SS1NL/SS1NH

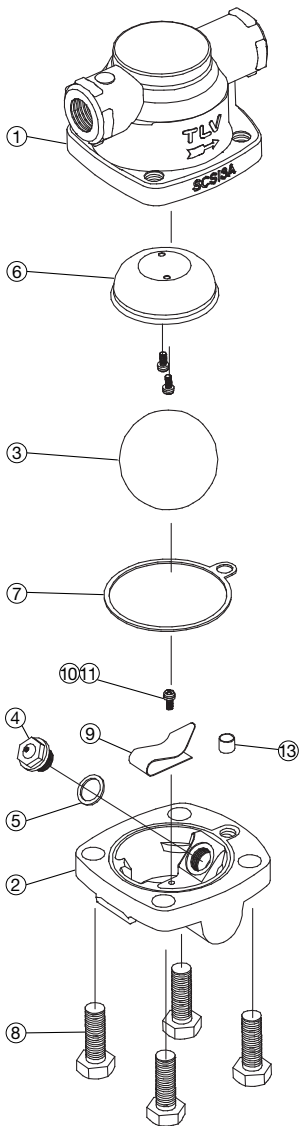

SS1VL/SS1VH

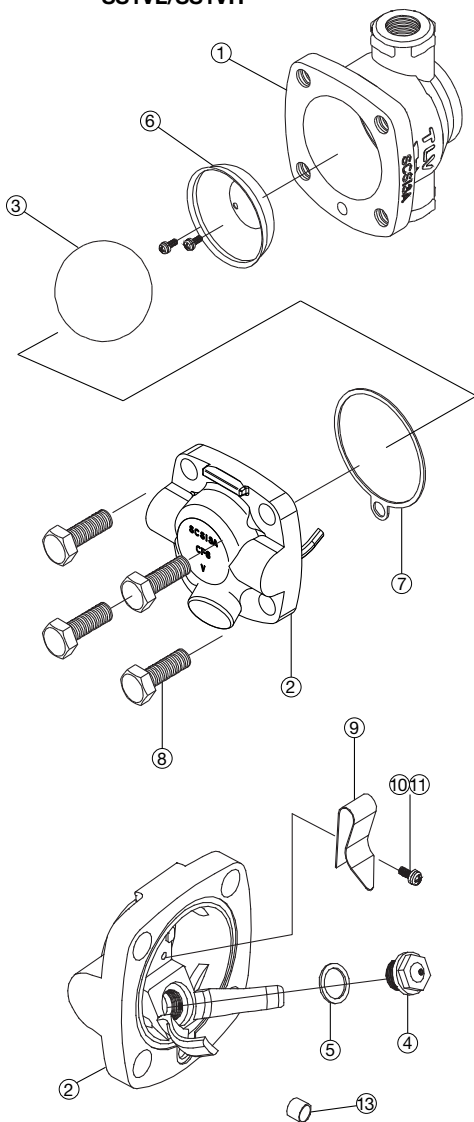

## 5. Proper Installation



- Installation, inspection, maintenance, repairs, disassembly, adjustment and valve opening/closing should be carried out only by trained maintenance personnel.
- Take measures to prevent people from coming into direct contact with product outlets.
- Install for use under conditions in which no freeze-up will occur.
- Install for use under conditions in which no water hammer will occur.

1. Before installation, be sure to remove all protective seals.
2. Before installing the trap, blow out the inlet piping to remove all dirt and oil.
3. Install the steam trap within the allowable inclination, as shown below. Also make sure that the arrow mark on the body corresponds with the direction of flow.
4. Install the trap in the lowest part of the pipeline or equipment so the condensate flows naturally into the trap by gravity. The inlet pipe should be as short and have as few bends as possible.
5. Support the pipes properly within 800 mm (2.5 ft) on either side of the trap.
6. Install a bypass valve to discharge condensate, and inlet and outlet valves to isolate the trap in the event of trap failure or when performing maintenance.
7. Install a check valve at the trap outlet whenever more than one trap is connected to the condensate collection pipeline.
8. The use of unions is recommended to facilitate connection and disconnection of screwed models.

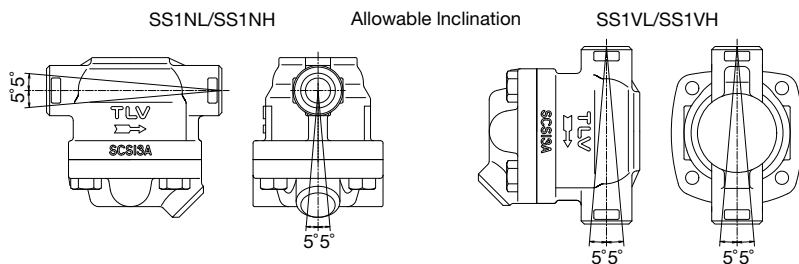

## 6. Piping Arrangement

Requirement	Correct	Incorrect
Install a catchpot with the proper diameter.		<p>Diameter is too small.</p>
Make sure the flow of condensate is not obstructed.		<p>Diameter is too small and inlet protrudes into pipe.</p>
To prevent rust and scale from flowing into the trap, connect the inlet pipe 25 - 50 mm (1 - 2 in) above the base of the T - pipe.		<p>Rust and scale flow into the trap with the condensate.</p>
When installing on the blind end, make sure nothing obstructs the flow of condensate.		<p>Condensate collects in the pipe.</p>

Check to make sure that the pipes connected to the trap have been installed properly.

1. Is the pipe diameter suitable?
2. Has the trap been installed within the allowable inclination and with the arrow on the body pointing in the direction of flow?
3. Has sufficient space been secured for maintenance?
4. Have maintenance valves been installed at the inlet and outlet? If the outlet is subject to back pressure, has a check valve been installed?
5. Is the inlet pipe as short as possible, with as few bends as possible, and installed so that the condensate will flow naturally down into the trap?
6. Has the piping work been done with the proper methods, as shown in the table on page 5?

## 7. Operational Check

A visual inspection can be carried out to aid in determining the necessity for immediate maintenance or repair, if the trap is open to atmosphere. If the trap does not discharge to atmosphere, use diagnostic equipment such as TLV TrapMan or TLV Pocket TrapMan.

Normal:	Condensate is discharged continuously with flash steam and the sound of flow can be heard. If there is very little condensate, there is almost no sound of flow.
Blocked:	No condensate is discharged. The trap is quiet and makes no noise, and the surface temperature of the trap is low.
Blowing:	Live steam continually flows from the outlet and there is a continuous metallic sound.
Steam Leakage:	Live steam is discharged through the trap outlet together with the condensate and there is a high-pitched sound.

(When conducting a visual inspection, flash steam is sometimes mistaken for steam leakage. For this reason, the use of a steam trap diagnostic instrument such as TLV TrapMan is highly recommended.)

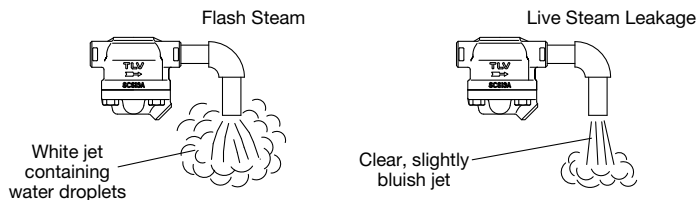

## 8. Inspection and Maintenance

Operational inspections should be performed at least twice per year, or as called for by trap operating conditions. Steam trap failure may result in temperature drop in the equipment, poor product quality or losses due to steam leakage.



NEVER apply direct heat to the float. The float may explode due to increased internal pressure, causing accidents leading to serious injury or property and equipment damage.



- Installation, inspection, maintenance, repairs, disassembly, adjustment and valve opening/closing should be carried out only by trained maintenance personnel.
- Before attempting to open the trap, close the inlet and outlet isolation valves and wait until the trap has cooled completely. Failure to do so may result in burns.
- Be sure to use the proper components and NEVER attempt to modify the product.

Parts Inspection Procedure	
Body, Cover	Check inside for damage, dirt, grease, oil film, rust or scale
Gaskets	Check for warping or damage
Air Vent Strip	Check for damage
Screen	Check for clogging, corrosion or damage
Float	Check for deformation, damage, oil film or water inside
Orifice	Check for rust, scale, oil film, wear or damage

Disassembly / Reassembly (to reassemble, follow procedures in reverse)		
Part & No.	During Disassembly	During Reassembly
Cover Bolt 8	Remove with a socket wrench	Coat threads with anti-seize and tighten to the proper torque
Cover 2	Remove carefully; take care to prevent any damage to the float, which may fall out when the cover is removed	Make sure the sealing surfaces are clean and then reattach; be careful not to bend the float guides (SS1VL/SS1VH only); (Fig. A)
Cover Gasket 7	SS1NL/SS1VL: Remove if damaged	Replace with a new gasket if worn or damaged
	SS1NH/SS1VH: Remove gasket and clean sealing surfaces of cover and body	Replace with a new gasket, do not apply anti-seize
Float 3	Remove, being careful not to scratch its polished surface	Place inside the body (or on the cover), being careful not to scratch its polished surface
Screen 6 (with Screws 10 and Washers 11)	Remove the 2 screws with a Philips screwdriver, then remove the screen without bending	Remove any scale build-up on the surface and then reassemble (Fig. B); tighten screws to the proper torque.
Connector 13	Remove connector	Reinstall connector
Air Vent strip 9 (with Screw 10 and Washer 11)	Remove the screw with a Philips screwdriver, then remove the air vent strip without bending	Reinstall air vent strip without bending; tighten screw to the proper torque
Orifice 4	Remove with a socket wrench	Coat threads with anti-seize and tighten to the proper torque
Orifice Gasket 5	Remove gasket and clean sealing surfaces	Apply anti-seize to both sides and replace with a new gasket

Figure A

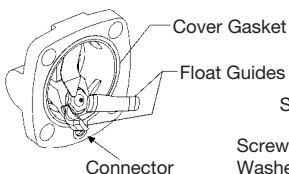
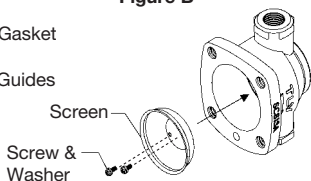

Figure B



Note: Do not change the position of the float guides. Tight sealing cannot be guaranteed if the float guides have been moved out of position.

Tightening Torque and Distance Across Flats								
Cover Bolt 8			Orifice 4			Screw 10		
N·m	(lb-ft)	mm (in)	N·m	(lb-ft)	mm (in)	N·m	(lb-ft)	mm (in)
45	(33)	17 (2 <sup>1</sup> / <sub>32</sub> )	20	(15)	13 (1/2)	0.3	(0.22)	+ (+)

1 N·m ≈ 10 kg·cm

If drawings or other special documentation were supplied for the product, any torque given there takes precedence over values shown here.



## 9. Instructions for Plug / Holder Disassembly and Reassembly

The seal on the threaded plugs/holders found on TLV products is formed by a flat metal gasket. There are various installation orientations for the gaskets, such as horizontal, diagonal and downward, and the gasket may be pinched in the thread recesses during assembly.

### Instructions for Disassembly and Reassembly

- ① Remove the plug/holder using a tool of the specified size (distance across flats).
- ② The gasket should not be reused. Be sure to replace it with a new gasket.
- ③ Clean the gasket surfaces of the plug/holder and the product body using a rag and/or cleaning agents, then check to make sure the surfaces are not scratched or deformed.
- ④ Coat both the gasket surface of the plug/holder and the threads of the plug/holder with anti-seize, then press the gasket onto the center of the gasket surface of the plug/holder, making sure the anti-seize affixes the gasket tightly to the plug/holder. Check to make sure the gasket is not caught in the recesses of the threads.
- ⑤ Hold the plug/holder upside down to make sure that the anti-seize makes the gasket stick to the plug/holder even when the plug/holder is held upside down.
- ⑥ Screw the plug/holder by hand into the product body while making sure that the gasket remains tightly affixed to the center of the gasket surface of the plug/holder. Make sure the entire gasket is making contact with the gasket surface of the product body. It is important at this point to make sure the gasket is not pinched in the thread recesses of the plug/holder.
- ⑦ Tighten the plug/holder to the proper torque.
- ⑧ Next, begin the supply of steam and check to make sure there is no leakage from the part just tightened. If there is leakage, immediately close the inlet valve and, if there is a bypass valve, take the necessary steps to release any residual pressure. After the surface of the product cools to room temperature, repeat the procedure beginning from step ①.

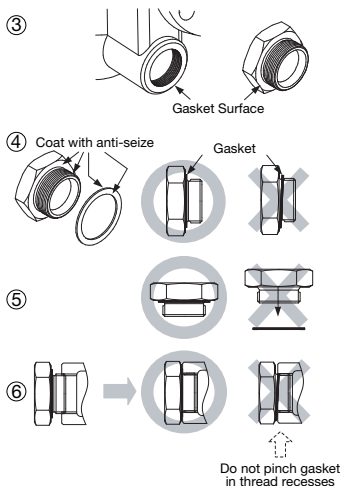

## 10. Troubleshooting

If the expected performance is unachievable after installation of the steam trap, read chapters 5 and 6 again and check the following points for appropriate corrective measures.

<b>Problem</b>	<b>Cause</b>	<b>Remedy</b>
No condensate is discharged or discharge is poor (blocked)	Float is damaged or filled with condensate	Replace with new float
	The float is sticking to the valve seat	Clean
	Orifice, screen or piping is clogged with rust or scale	Clean
	Steam-locking has occurred	Blowdown through the bypass or close the trap inlet valve and allow the trap to cool
	Flow exceeds trap's rated capacity	Check specifications and reselect trap suitable for actual flow
	The trap operating pressure exceeds the maximum specified pressure, or there is insufficient differential pressure between the trap inlet and outlet	Compare specifications and actual operating conditions
Steam is discharged or leaks from the trap outlet (blowing) (steam leakage)	Rust and scale have accumulated around the valve seat or under the float	Clean
	The Orifice is damaged	Replace with new valve seat
	Float is deformed or coated with scale	Clean or replace the float
	Trap is installed above the maximum allowable inclination angle	Correct the installation
	Vibration of trap occurs	Lengthen inlet piping, then fasten it securely
Steam leaks from a place other than the trap outlet	The air vent strip is damaged	Replace with a new air vent strip
	Deterioration of or damage to gaskets	Replace with new gaskets
Float is frequently damaged	Improper tightening torque for cover was used	Tighten to the proper torque
	Water hammer occurs	Examine the piping for problems that can cause water hammer

NOTE: When replacing parts with new, use the parts list on page 3 for reference, and replace with parts from the respective replacement parts kits.

# 11. TLV EXPRESS LIMITED WARRANTY

Subject to the limitations set forth below, TLV Corporation, a North Carolina corporation (“TLV”) warrants that products which are sold by it, TLV CO., LTD., a Japanese corporation (“TLVJ”) or TLV International, Inc., a Japanese corporation (“TII”), (hereinafter the “Products”) are designed and manufactured by TLVJ, conform to the specifications published by TLV for the corresponding part numbers (the “Specifications”) and are free from defective workmanship and materials. With regard to products or components manufactured by unrelated third parties (the “Components”), TLV provides no warranty other than the warranty from the third party manufacturer(s), if any.

## Exceptions to Warranty

This warranty does not cover defects or failures caused by:

1. improper shipping, installation, use, handling, etc., by other than TLV or service representatives authorized by TLV; or
2. dirt, scale or rust, etc.; or
3. improper disassembly and reassembly, or inadequate inspection and maintenance by other than TLV or service representatives authorized by TLV; or
4. disasters or forces of nature or Acts of God; or
5. abuse, abnormal use, accidents or any other cause beyond the control of TLV; or
6. improper storage, maintenance or repair; or
7. operation of the Products not in accordance with instructions issued with the Products or with accepted industry practices; or
8. use for a purpose or in a manner for which the Products were not intended; or
9. use of the Products in a manner inconsistent with the Specifications; or
10. use of the Products with Hazardous Fluids (fluids other than steam, air, water, nitrogen, carbon dioxide and inert gases (helium, neon, argon, krypton, xenon and radon)); or
11. failure to follow the instructions contained in the TLV Instruction Manual for the Product.

## Duration of Warranty

This warranty is effective for a period of the earlier of: (i) three (3) years after delivery of Products to the first end user in the case of sealed SST-Series Products for use in steam pressure service up to 650 psig; (ii) two (2) years after delivery of Products to the first end user in the case of PowerTrap® units; or (iii) one (1) year after delivery of Products to the first end user in the case of all other Products. Notwithstanding the foregoing, asserting a claim under this warranty must be brought by the earlier of one of the foregoing periods, as applicable, or within five (5) years after the date of delivery to the initial buyer if not sold initially to the first end user.

ANY IMPLIED WARRANTIES NOT NEGATED HEREBY WHICH MAY ARISE BY OPERATION OF LAW, INCLUDING THE IMPLIED WARRANTIES OF MERCHANTABILITY AND FITNESS FOR A PARTICULAR PURPOSE AND ANY EXPRESS WARRANTIES NOT NEGATED HEREBY, ARE GIVEN SOLELY TO THE INITIAL BUYER AND ARE LIMITED IN DURATION TO ONE (1) YEAR FROM THE DATE OF SHIPMENT BY TLV.

## Exclusive Remedy

THE EXCLUSIVE REMEDY UNDER THIS WARRANTY, UNDER ANY EXPRESS WARRANTY OR UNDER ANY IMPLIED WARRANTIES NOT NEGATED HEREBY (INCLUDING THE IMPLIED WARRANTIES OF MERCHANTABILITY AND FITNESS FOR A PARTICULAR PURPOSE), IS **REPLACEMENT**; PROVIDED: (a) THE CLAIMED DEFECT IS REPORTED TO TLV IN WRITING WITHIN THE APPLICABLE WARRANTY PERIOD, INCLUDING A DETAILED WRITTEN DESCRIPTION OF THE CLAIMED DEFECT AND HOW AND WHEN THE CLAIMED DEFECTIVE PRODUCT WAS USED; AND (b) THE CLAIMED DEFECTIVE PRODUCT AND A COPY OF THE PURCHASE INVOICE IS RETURNED TO TLV, FREIGHT AND TRANSPORTATION COSTS PREPAID, UNDER A RETURN MATERIAL AUTHORIZATION AND TRACKING NUMBER ISSUED BY TLV. ALL LABOR COSTS, SHIPPING COSTS, AND TRANSPORTATION COSTS ASSOCIATED WITH THE RETURN OR REPLACEMENT OF THE CLAIMED DEFECTIVE PRODUCT ARE SOLELY THE RESPONSIBILITY OF BUYER OR THE FIRST END USER. TLV RESERVES THE RIGHT TO INSPECT ON THE FIRST END USER'S SITE ANY PRODUCTS CLAIMED TO BE DEFECTIVE BEFORE ISSUING A RETURN MATERIAL AUTHORIZATION. SHOULD SUCH INSPECTION REVEAL, IN TLV'S REASONABLE DISCRETION, THAT THE

CLAIMED DEFECT IS NOT COVERED BY THIS WARRANTY, THE PARTY ASSERTING THIS WARRANTY SHALL PAY TLV FOR THE TIME AND EXPENSES RELATED TO SUCH ON-SITE INSPECTION.

### **Exclusion of Consequential and Incidental Damages**

IT IS SPECIFICALLY ACKNOWLEDGED THAT THIS WARRANTY, ANY OTHER EXPRESS WARRANTY NOT NEGATED HEREBY, AND ANY IMPLIED WARRANTY NOT NEGATED HEREBY, INCLUDING THE IMPLIED WARRANTIES OF MERCHANTABILITY AND FITNESS FOR A PARTICULAR PURPOSE, DO NOT COVER, AND NEITHER TLV, TII NOR TLVJ WILL IN ANY EVENT BE LIABLE FOR, INCIDENTAL OR CONSEQUENTIAL DAMAGES, INCLUDING, BUT NOT LIMITED TO LOST PROFITS, THE COST OF DISASSEMBLY AND SHIPMENT OF THE DEFECTIVE PRODUCT, INJURY TO OTHER PROPERTY, DAMAGE TO BUYER'S OR THE FIRST END USER'S PRODUCT, DAMAGE TO BUYER'S OR THE FIRST END USER'S PROCESSES, LOSS OF USE, OR OTHER COMMERCIAL LOSSES. WHERE, DUE TO OPERATION OF LAW, CONSEQUENTIAL AND INCIDENTAL DAMAGES UNDER THIS WARRANTY, UNDER ANY OTHER EXPRESS WARRANTY NOT NEGATED HEREBY OR UNDER ANY IMPLIED WARRANTY NOT NEGATED HEREBY (INCLUDING THE IMPLIED WARRANTIES OF MERCHANTABILITY AND FITNESS FOR A PARTICULAR PURPOSE) CANNOT BE EXCLUDED, SUCH DAMAGES ARE EXPRESSLY LIMITED IN AMOUNT TO THE PURCHASE PRICE OF THE DEFECTIVE PRODUCT. THIS EXCLUSION OF CONSEQUENTIAL AND INCIDENTAL DAMAGES, AND THE PROVISION OF THIS WARRANTY LIMITING REMEDIES HEREUNDER TO REPLACEMENT, ARE INDEPENDENT PROVISIONS, AND ANY DETERMINATION THAT THE LIMITATION OF REMEDIES FAILS OF ITS ESSENTIAL PURPOSE OR ANY OTHER DETERMINATION THAT EITHER OF THE ABOVE REMEDIES IS UNENFORCEABLE, SHALL NOT BE CONSTRUED TO MAKE THE OTHER PROVISIONS UNENFORCEABLE.

### **Exclusion of Other Warranties**

THIS WARRANTY IS IN LIEU OF ALL OTHER WARRANTIES, EXPRESS OR IMPLIED, AND ALL OTHER WARRANTIES, INCLUDING BUT NOT LIMITED TO THE IMPLIED WARRANTIES OF MERCHANTABILITY AND FITNESS FOR A PARTICULAR PURPOSE, ARE EXPRESSLY DISCLAIMED.

### **Severability**

Any provision of this warranty which is invalid, prohibited or unenforceable in any jurisdiction shall, as to such jurisdiction, be ineffective to the extent of such invalidity, prohibition or unenforceability without invalidating the remaining provisions hereof, and any such invalidity, prohibition or unenforceability in any such jurisdiction shall not invalidate or render unenforceable such provision in any other jurisdiction.

## **TLV CORPORATION**

13901 South Lakes Drive, Charlotte, NC 28273-6790, U.S.A.

Tel: [1]-704-597-9070

Fax: [1]-704-583-1610

Printed on recycled paper.

PAC-65395-a

Rev. 10/2023 (M)