

ISO 9001
ISO 14001



Manufacturer

TLV CO., LTD.

Kakogawa, Japan

is approved by LRQA Ltd. to ISO 9001/14001

TLV[®]

Instruction Manual

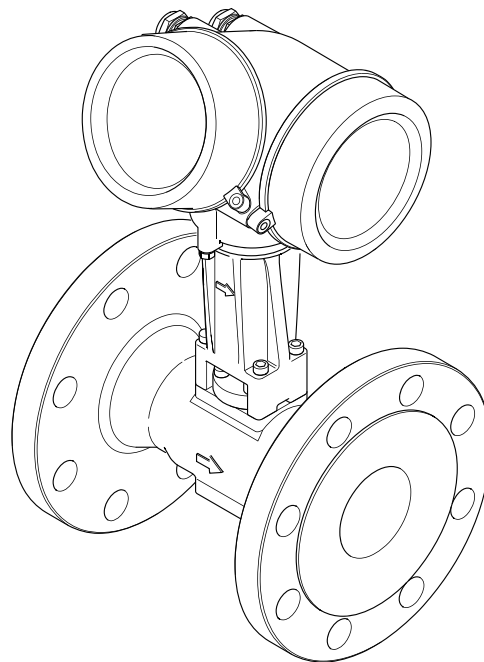

Vortex flowmeter

EF200R-C

Copyright © 2022 by TLV CO., LTD.

All rights reserved

- Make sure the document is stored in a safe place such that it is always available when working on or with the device.
- To avoid danger to individuals or the facility, read the "Basic safety instructions" section carefully, as well as all other safety instructions in the document that are specific to working procedures.
- The manufacturer reserves the right to modify technical data without prior notice. Your TLV Sales Center will supply you with current information and updates to these instructions.

Table of contents

1	About this document	6	Installation
1.1	Document function	6.1	Installation conditions
1.2	Symbols	6.1.1	Mounting position
1.2.1	Safety symbols	6.1.2	Environment and process requirements
1.2.2	Electrical symbols	6.1.3	Ensuring accurate measurements
1.2.3	Tool symbols	6.2	Mounting the measuring device
1.2.4	Symbols for certain types of information	6.2.1	Required tools
1.2.5	Symbols in graphics	6.2.2	Preparing the measuring device
1.3	Documentation	6.2.3	Mounting the sensor
1.3.1	Standard documentation	6.2.4	Mounting the pressure measuring unit
1.3.2	Supplementary device-dependent documentation	6.2.5	Mounting the transmitter of the remote version
2	Safety instructions	6.2.6	Turning the transmitter housing
2.1	Requirements for the personnel	6.2.7	Turning the display module
2.2	Designated use	6.3	Post-installation check
2.3	Workplace safety	7	Electrical connection
2.4	Operational safety	7.1	Connection conditions
2.5	Product safety	7.1.1	Required tools
2.6	IT security	7.1.2	Connecting cable requirements
2.7	Device-specific IT security	7.1.3	Connecting cable for remote version
2.7.1	Protecting access via hardware write protection	7.1.4	Terminal assignment
2.7.2	Protecting access via a password	7.1.5	Requirements for the supply unit
2.7.3	Access via fieldbus	7.1.6	Preparing the measuring device
2.8	Vibrations	7.2	Connecting the measuring device
2.9	Preventing Excessive Flow	7.2.1	Connecting the compact version
2.10	Pulsating Influences	7.2.2	Connecting the remote version
2.11	Prevent Mixed Phase Flowy	7.2.3	Connecting the connecting cable for the pressure measuring cell
2.12	Ensure Pipe is Flooded	7.2.4	Ensuring potential equalization
2.13	Bypass Lines	7.3	Ensuring the degree of protection
3	Product description	7.4	Post-connection check
3.1	Product design	7.5	Connecting to TLV EC351 Flow Computer
4	Incoming acceptance and product identification	8	Operation options
4.1	Incoming acceptance	8.1	Overview of operation options
4.2	Product identification	8.2	Structure and function of the operating menu
4.2.1	Transmitter nameplate	8.2.1	Structure of the operating menu
4.2.2	Sensor nameplate(remote version)	8.2.2	Operating philosophy
4.2.3	Nameplate for TEG (compact version/remote version)	8.3	Access to the operating menu via the local display
5	Storage and transport	8.3.1	Operational display
5.1	Storage conditions	8.3.2	Navigation view
5.2	Transporting the product	8.3.3	Editing view
5.2.1	Measuring devices without lifting lugs	8.3.4	Operating elements
5.2.2	Measuring devices with lifting lugs	8.3.5	Opening the context menu
		8.3.6	Navigating and selecting from list
		8.3.7	Calling the parameter directly
		8.3.8	Calling up help text
		8.3.9	Changing the parameters

8.3.10	User roles and related access authorization	11	Operation
8.3.11	Disabling write protection via access code	11.1	Reading the device locking status
8.3.12	Enabling and disabling the keypad lock	11.2	Adjusting the operating language
8.4	Access to the operating menu via the operating tool	11.3	Configuring the display
8.4.1	Connecting the operating tool	11.4	Reading measured values
9	System integration	11.4.1	Process variables
9.1	Overview of device description files	11.4.2	"Totalizer" submenu
9.1.1	Current version date for the device	11.4.3	Input values
10	Commissioning	11.4.4	Output values
10.1	Function check	11.5	Adapting the measuring device to the process conditions
10.2	Switching on the measuring device	11.6	Performing a totalizer reset
10.3	Setting the operating language	11.6.1	Function scope of the "Control Totalizer" parameter
10.4	Configuring the measuring device	11.6.2	Function scope of the "Reset all totalizers" parameter
10.4.1	Defining the tag name	12	Diagnostics and troubleshooting
10.4.2	Setting the system units	12.1	General troubleshooting
10.4.3	Selecting and setting the medium	12.2	Diagnostic information on local display
10.4.4	Configuring the current input	12.2.1	Diagnostic message
10.4.5	Configuring the current output	12.2.2	Calling up remedial measures
10.4.6	Configuring the pulse/frequency/switch output	12.3	Adapting the diagnostic information
10.4.7	Configuring the local display	12.3.1	Adapting the diagnostic behavior
10.4.8	Configuring the low flow cut off	12.3.2	Adapting the status signal
10.5	Advanced settings	12.4	Overview of diagnostic information
10.5.1	Setting the medium properties	12.4.1	Operating conditions for displaying the following diagnostics information
10.5.2	Performing external compensation	12.4.2	Emergency mode in the event of pressure compensation
10.5.3	Carrying out a sensor adjustment	12.4.3	Emergency mode in event of temperature compensation
10.5.4	Configuring the totalizer	12.5	Pending diagnostic events
10.5.5	Carrying out additional display configurations	12.6	Diagnostic list
10.5.6	Configuration management	12.7	Event logbook
10.5.7	Using parameters for device administration	12.7.1	Reading out the event logbook
10.6	Configuration management	12.7.2	Filtering the event logbook
10.6.1	Function scope of the "Configuration management" parameter	12.7.3	Overview of information events
10.7	Simulation	12.8	Resetting the measuring device
10.8	Protecting settings from unauthorized access	12.8.1	Function scope of the "Device reset" parameter
10.8.1	Write protection via access code	12.9	Device information
10.8.2	Write protection via write protection switch	13	Maintenance
10.9	Application-specific commissioning	13.1	Maintenance tasks
10.9.1	Steam application	13.1.1	Exterior cleaning
10.9.2	Liquid application	13.1.2	Interior cleaning
10.9.3	Gas applications	13.1.3	Replacing seals
10.9.4	Calculation of the measured variables	13.1.4	Adjusting the pressure measuring cell

14	Repair
14.1	General notes
14.1.1	Repair and conversion concept
14.1.2	Notes for repair and conversion
14.2	Spare parts
14.3	Disposal
14.3.1	Removing the measuring device
14.3.2	Disposing of the measuring device
15	Accessories
15.1	Device-specific accessories
15.1.1	For the transmitter
15.1.2	For the sensor
16	Technical data
16.1	Application
16.2	Function and system design
16.3	Input
16.4	Output
16.5	Power supply
16.6	Performance characteristics
16.7	Installation
16.8	Environment
16.9	Process
16.10	Mechanical construction
16.11	Operability
16.12	Certificates and approvals
16.13	Application packages
16.14	Accessories
16.15	Supplementary documentation
17	Flow Rate data
18	Functional Matrix
19	TLV EXPRESS LIMITED WARRANTY
20	Services

1 About this document

1.1 Document function

These Operating Instructions contain all the information that is required in various phases of the life cycle of the device: from product identification, incoming acceptance and storage, to mounting, connection, operation and commissioning through to troubleshooting, maintenance and disposal.

1.2 Symbols

1.2.1 Safety symbols



This symbol alerts you to a dangerous situation. Failure to avoid this situation will result in serious or fatal injury.



This symbol alerts you to a dangerous situation. Failure to avoid this situation can result in serious or fatal injury.



This symbol alerts you to a dangerous situation. Failure to avoid this situation can result in minor or medium injury.





This symbol contains information on procedures and other facts which do not result in personal injury.













1.2.2 Electrical symbols

Symbol	Meaning
	Direct current
	Alternating current
	Direct current and alternating current
	Ground connection A grounded terminal which, as far as the operator is concerned, is grounded via a grounding system.
	Protective Earth (PE) A terminal which must be connected to ground prior to establishing any other connections. The ground terminals are situated inside and outside the device: <ul style="list-style-type: none"> • Inner ground terminal: Connects the protective earth to the mains supply. • Outer ground terminal: Connects the device to the plant grounding system.



1.2.3 Tool symbols

Symbol	Meaning
	Flat blade screwdriver
	Allen key
	Open-ended wrench

1.2.4 Symbols for certain types of information

Symbol	Meaning
	Permitted Procedures, processes or actions that are permitted.
	Preferred Procedures, processes or actions that are preferred.
	Forbidden Procedures, processes or actions that are forbidden.
	Tip Indicates additional information.
	Reference to documentation.
	Reference to page.
	Reference to graphic.
	Notice or individual step to be observed.
	Series of steps.
	Result of a step.
	Help in the event of a problem.
	Visual inspection.

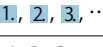
1.2.5 Symbols in graphics

Symbol	Meaning
1, 2, 3, ...	Item numbers
	Series of steps
A, B, C, ...	Views
A-A, B-B, C-C, ...	Sections
	Flow direction

1.3 Documentation

i For an overview of the scope of the associated Technical Documentation, refer to the following:

Detailed list of the individual documents along with the documentation code
→ See 16.15

1.3.1 Standard documentation

Document type	Purpose and content of the document
Instruction Manual (this document)	This document contains all the information that is required in various phases of the life cycle of the device: from product identification, incoming acceptance and storage, to mounting, connection, operation and commissioning through to troubleshooting, maintenance and disposal
Technical Information	Planning aid for your device The document contains all the technical data on the device and provides an overview of the accessories and other products that can be ordered for the device.
Brief Operating Instructions	Guides you quickly to the 1st measured value The Brief Operating Instructions are aimed at specialists with responsibility for installing, configuring and parameterizing the measuring device (until the first measured value). <ul style="list-style-type: none"> • Incoming acceptance and product identification • Storage and transport • Installation • Product description • Electrical connection • Operation options • Commissioning • Diagnostic information
Description of Device Parameters	Reference for your parameters The document provides a detailed explanation of each individual parameter in the Expert operating menu. The description is aimed at those who work with the device over the entire life cycle and perform specific configurations.

1.3.2 Supplementary device-dependent documentation

Additional documents are supplied depending on the device version ordered: Always comply strictly with the instructions in the supplementary documentation. The supplementary documentation is an integral part of the device documentation.

2 Safety instructions

2.1 Requirements for the personnel

The personnel for installation, commissioning, diagnostics and maintenance must fulfill the following requirements:

- ▶ Trained, qualified specialists must have a relevant qualification for this specific function and task.
- ▶ Are authorized by the plant owner/operator.
- ▶ Are familiar with federal/national regulations.
- ▶ Before starting work, read and understand the instructions in the manual and supplementary documentation as well as the certificates (depending on the application).
- ▶ Follow instructions and comply with basic conditions.

The operating personnel must fulfill the following requirements:

- ▶ Are instructed and authorized according to the requirements of the task by the facility's owner-operator.
- ▶ Follow the instructions in this manual.

2.2 Designated use

Application and media

The measuring device described in this manual is intended only for flow measurement of liquids with a minimum conductivity of 20 $\mu\text{S}/\text{cm}$.

The EF200R-C vortex flowmeter is used to measure the flow of saturated steam, superheated steam, air and water. Do not use to measure the flow of toxic, flammable or otherwise hazardous fluids.

To ensure that the measuring device remains in proper condition for the operation time:

- ▶ Keep within the specified pressure and temperature range.
- ▶ Only use the measuring device in full compliance with the data on the nameplate and the general conditions listed in the Operating Instructions and supplementary documentation.
- ▶ Use the measuring device only for media to which the process-wetted materials are sufficiently resistant.
- ▶ Protect the measuring device permanently against corrosion from environmental influences.

Incorrect use

Non-designated use can compromise safety. The manufacturer is not liable for damage caused by improper or non-designated use.



Danger of breakage due to corrosive or abrasive fluids and ambient conditions!

- ▶ Verify the compatibility of the process fluid with the sensor material.
- ▶ Ensure the resistance of all fluid-wetted materials in the process.
- ▶ Keep within the specified pressure and temperature range.

Residual risks



The electronics and the medium may cause the surfaces to heat up. This presents a burn hazard!

- ▶ For elevated fluid temperatures, ensure protection against contact to prevent burns.

2.3 Workplace safety

For work on and with the device:

- ▶ Wear the required personal protective equipment according to federal/national regulations.

For welding work on the piping:

- ▶ Do not ground the welding unit via the measuring device.

If working on and with the device with wet hands:

- ▶ Due to the increased risk of electric shock, gloves must be worn.

2.4 Operational safety

Risk of injury.

- ▶ Operate the device in proper technical condition and fail-safe condition only. The operator is responsible for interference-free operation of the device.

Conversions to the device

Unauthorized modifications to the device are not permitted and can lead to unforeseeable dangers.

- ▶ If, despite this, modifications are required, consult with TLV.

Repair

To ensure continued operational safety and reliability,

- ▶ Carry out repairs on the device only if they are expressly permitted.
- ▶ Observe federal/national regulations pertaining to repair of an electrical device.
- ▶ Use original spare parts and accessories from TLV only.

2.5 Product safety

This measuring device is designed in accordance with good engineering practice to meet state-of-the-art safety requirements, has been tested, and left the factory in a condition in which it is safe to operate.

It meets general safety standards and legal requirements. It also complies with the EU directives listed in the device-specific EU Declaration of Conformity.

Product conformity is indicated by the affixation of the CE mark to the device.

2.6 IT security

Our warranty is valid only if the device is installed and used as described in the Operating Instructions. The device is equipped with security mechanisms to protect it against any inadvertent changes to the settings.

IT security measures, which provide additional protection for the device and associated data transfer, must be implemented by the operators themselves in line with their security standards.

2.7 Device-specific IT security

The device offers a range of specific functions to support protective measures on the operator's side. These functions can be configured by the user and guarantee greater in-operation safety if used correctly. An overview of the most important functions is provided in the following section.

2.7.1 Protecting access via hardware write protection

Write access to the device parameters via the local display or operating tool can be disabled via a write protection switch (DIP switch on the motherboard). When hardware write protection is enabled, only read access to the parameters is possible.

2.7.2 Protecting access via a password

A password can be used to protect against write access to the device parameters.

This password locks write access to the device parameters via the local display or another operating tool and, in terms of functionality, is equivalent to hardware write protection.

User-specific access code

Write access to the device parameters via the local display or operating tool can be protected by the modifiable, user-specific access code (→ See 10.8.1).

When the device is delivered, the device does not have an access code and is equivalent to 0000 (open).

General notes on the use of passwords

- The access code and network key supplied with the device should be changed during commissioning.
- Follow the general rules for generating a secure password when defining and managing the access code or network key.
- The user is responsible for the management and careful handling of the access code and network key.
- For information on configuring the access code or on what to do if you lose the password, see the "Write protection via access code" section → See 10.8.1

2.7.3 Access via fieldbus

Cyclic fieldbus communication (read and write, e.g. measured value transmission) with a higher-order system is not affected by the restrictions mentioned above.

2.8 Vibrations

The correct operation of the measuring system is not influenced by plant vibrations vibration resistance (→see 16.8) Consequently, the sensors require no special measures for attachment. If higher levels of vibration are expected, be sure to secure piping before and after the flow meter.

2.9 Preventing Excessive Flow

To ensure long service life for the flowmeter, excessive instantaneous/ periodical flow rates should be held below the flow meter's maximum flow rate. Failing to do so might result in damage to the sensor. Special care is necessary for steam at startup when the pressure is low, or when a valve is opened rapidly, such as by a solenoid valve, as excessive instantaneous flow rates often occur.

2.10 Pulsating Influences

The ability of the flowmeter to measure correctly may be adversely affected if there are large variations of pressure or pulsating pressure from compressors and/or soot blowers. Use the procedures below to minimize pulsating pressures:

- Move the source of the pulsations to the downstream side of the flowmeter. Alternatively, put as much distance as possible between the source and the flowmeter.
- Install a pulsation dampening device, such as a chamber.
- Close the valves before and after the flowmeter when there is no flow. (This is to prevent false non-zero readings under zero-flow conditions.)

2.11 Prevent Mixed Phase Flow

This flowmeter is designed to measure both gases and liquids. However, accurate measurement cannot be guaranteed when gases and liquids are mixed together (i.e. gas-liquid mixed phase flow).

2.12 Ensure Pipe is Flooded

When measuring liquids ensure that the pipe is flooded, as this will have an influence on the accuracy of flow rate measurements.

2.13 Bypass Lines

The installation of bypass lines can facilitate maintenance and inspections. When installing a bypass line, use upstream and downstream valves of a type that does not disturb the flow profile, and secure sufficient length of straight pipe.

3 Product description

The device consists of a transmitter and a sensor.

Two device versions are available:

- Compact version – transmitter and sensor form a mechanical unit.
- Remote version - transmitter and sensor are mounted in separate locations.

3.1 Product design

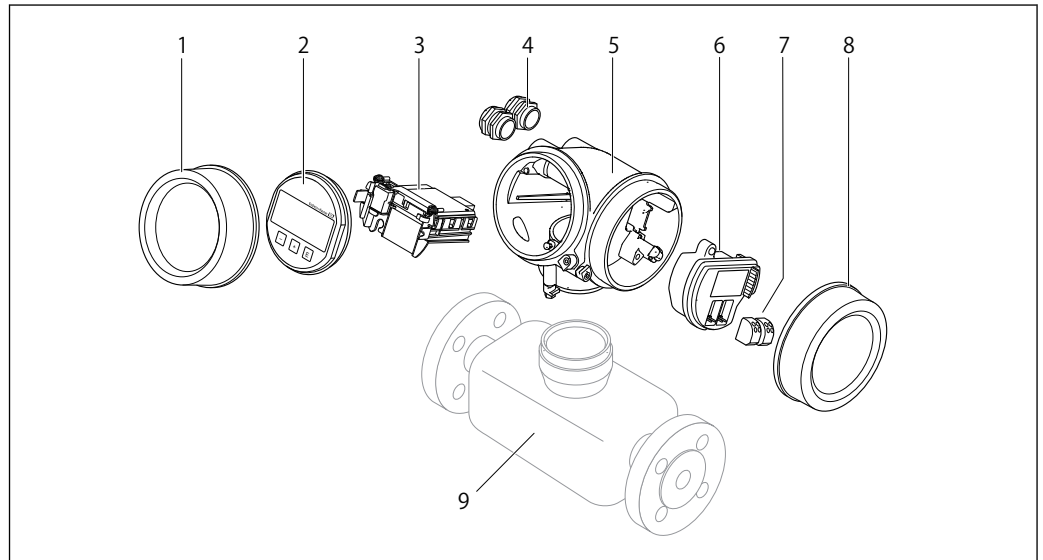

Important components of a measuring device

- 1 Electronics compartment cover
- 2 Display module
- 3 Main electronics module
- 4 Cable glands
- 5 Transmitter housing (incl. HistoROM)
- 6 I/O electronics module
- 7 Terminals (spring loaded terminals, pluggable)
- 8 Connection compartment cover
- 9 Sensor

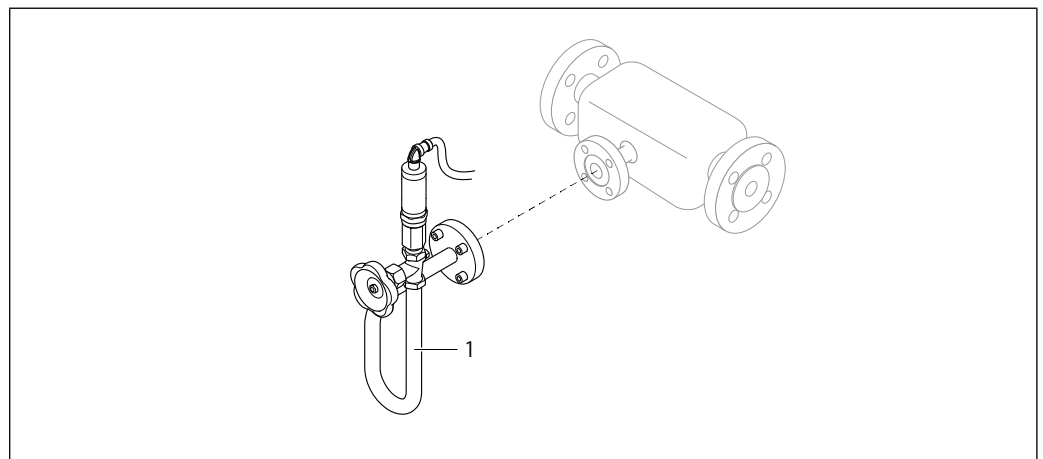

Versions of pressure measuring unit

- 1 Order code for "Sensor version; DSC sensor; measuring tube", option "Mass steam"

i For order code for "Sensor version; DSC sensor; measuring tube", option "Mass steam", the following applies: Oil-free or grease-free cleaning is not possible

4 Incoming acceptance and product identification

4.1 Incoming acceptance

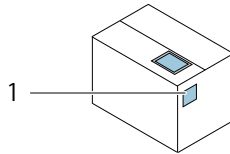

Are the product sticker (1) identical?

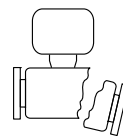
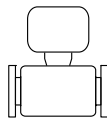
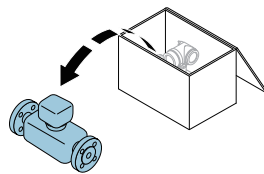

Are the goods undamaged?



Is the envelope present with accompanying documents?



- If one of the conditions is not satisfied, contact your TLV Sales Center.
- Contact TLV for Technical Documentation.

4.2 Product identification

The following options are available for identification of the device:

- Nameplate specifications
- Order code with breakdown of the device features on the delivery note

For an overview of the scope of the associated Technical Documentation, refer to the following:

4.2.1 Transmitter nameplate (compact version)

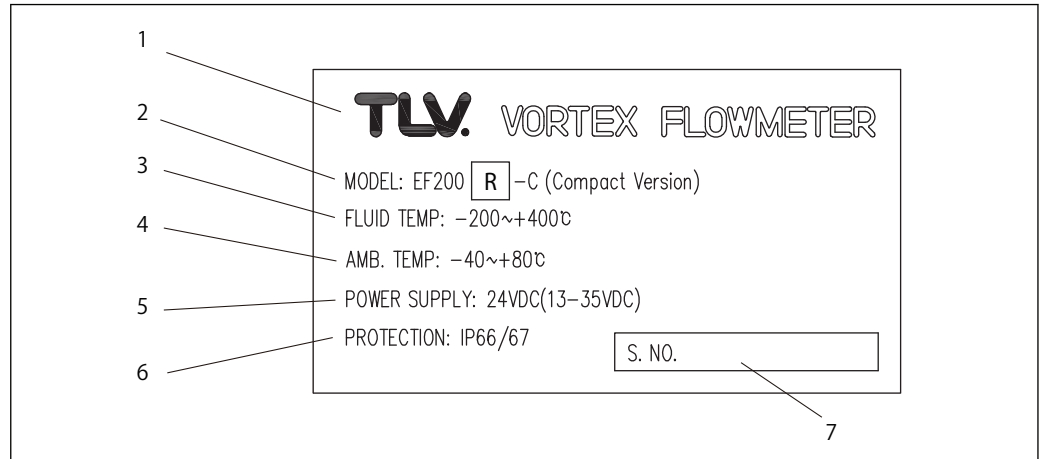

A0032237

- 1 Name of the transmitter
- 2 Model name
- 3 Permitted fluid temperature
- 4 Permitted ambient temperature
- 5 Power supply voltage
- 6 Degree of protection
- 7 Serial number (ser. no.)

4.2.2 Sensor nameplate (remote version)

Transmitter

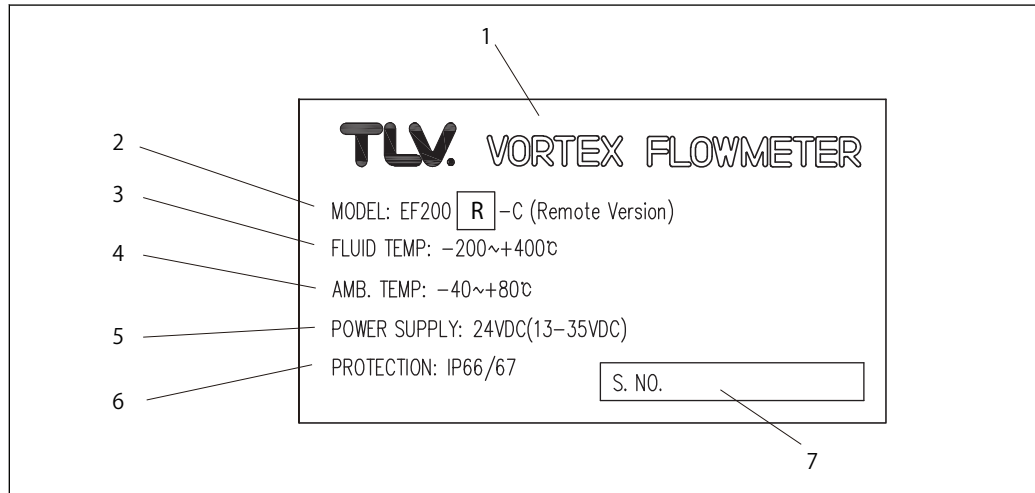

- 1 Name of the transmitter
- 2 Model name
- 3 Permitted fluid temperature
- 4 Permitted ambient temperature
- 5 Power supply voltage
- 6 Degree of protection
- 7 Serial number (ser. no.)

Sensor

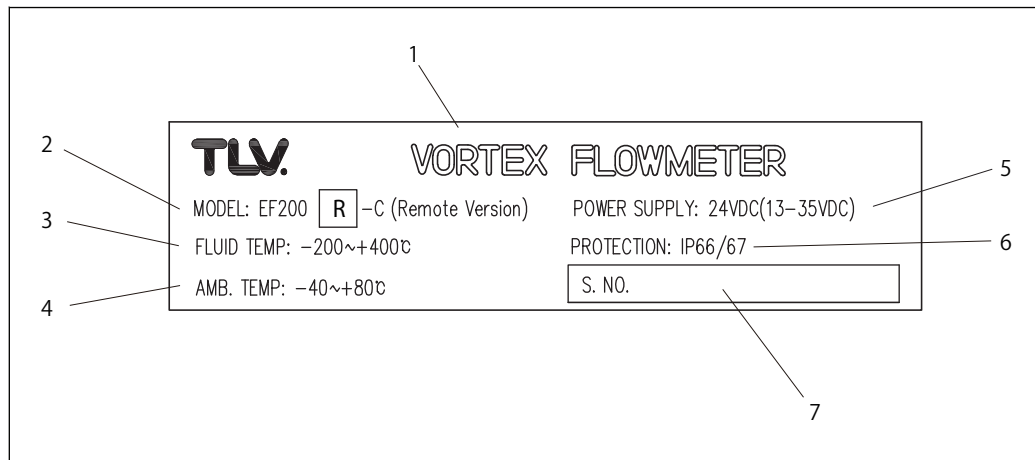

- 1 Name of the transmitter
- 2 Model name
- 3 Permitted fluid temperature
- 4 Permitted ambient temperature
- 5 Power supply voltage
- 6 Degree of protection
- 7 Serial number (ser. no.)

4.2.3 Nameplate for TEG (compact version/remote version)

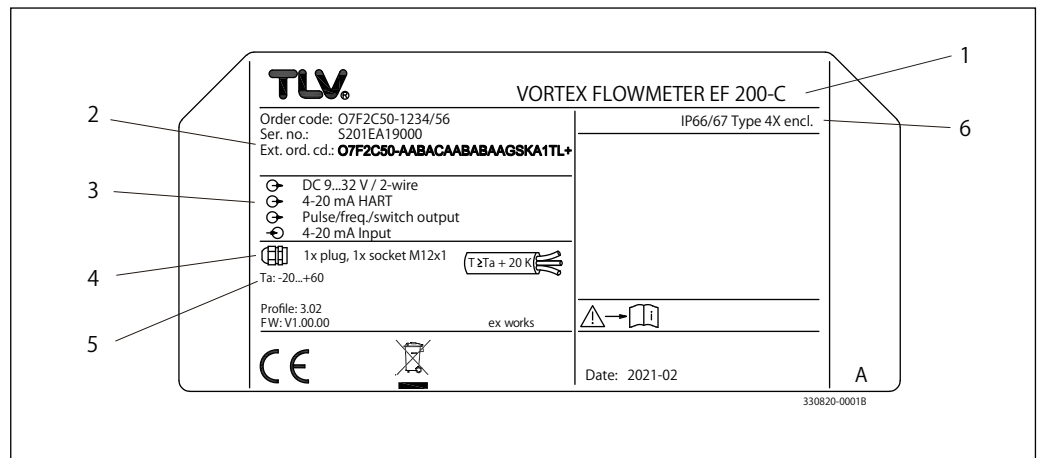

- 1 Name of the transmitter
- 2 Model name
- 3 Power supply voltage
- 4 Electrical connection thread
- 5 Permitted ambient temperature
- 6 Degree of protection

5 Storage and transport

5.1 Storage conditions

Observe the following notes for storage:

- ▶ Store in the original packaging to ensure protection from shock.
- ▶ Do not remove protective covers or protective caps installed on process connections. They prevent mechanical damage to the sealing surfaces and contamination in the measuring tube.
- ▶ Protect from direct sunlight to avoid unacceptably high surface temperatures.
- ▶ Store in a dry and dust-free place.
- ▶ Do not store outdoors.

Storage temperature: -50 to $+80$ °C (-58 to $+176$ °F)

5.2 Transporting the product

Transport the measuring device to the measuring point in the original packaging.

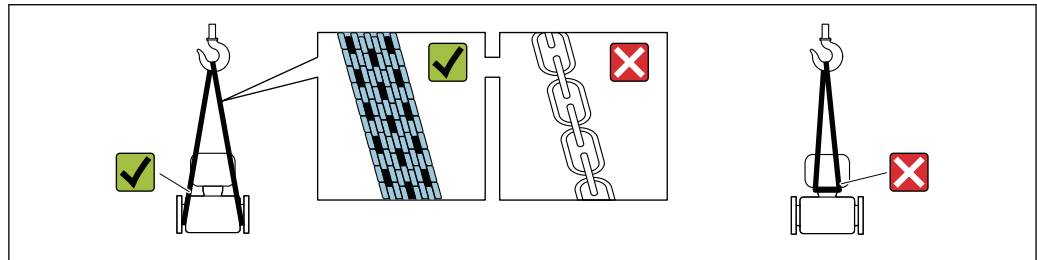

A0029252

- i** Do not remove protective covers or caps installed on process connections. They prevent mechanical damage to the sealing surfaces and contamination in the measuring tube.

5.2.1 Measuring devices without lifting lugs



Center of gravity of the measuring device is higher than the suspension points of the webbing slings.

Risk of injury if the measuring device slips.

- ▶ Secure the measuring device against slipping or turning.
- ▶ Observe the weight specified on the packaging (stick-on label).

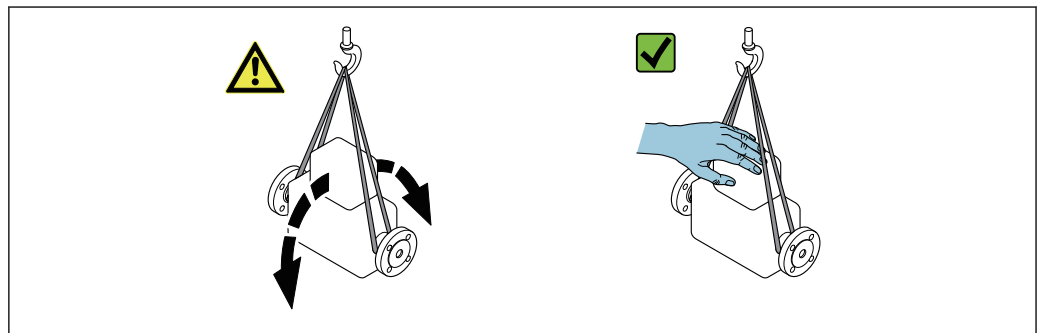

A0029214

5.2.2 Measuring devices with lifting lugs



Special transportation instructions for devices with lifting lugs

- ▶ Only use the lifting lugs fitted on the device or flanges to transport the device.
- ▶ The device must always be secured at two lifting lugs at least.

6 Installation

6.1 Installation conditions

6.1.1 Mounting position

Mounting location

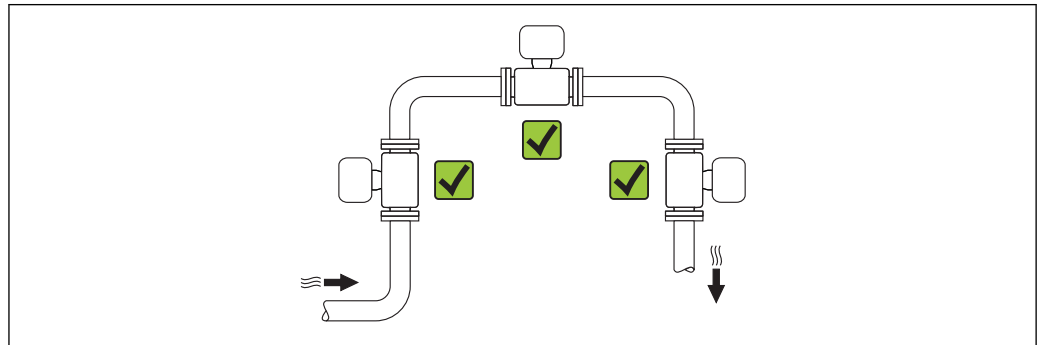

A0015543

Orientation

The direction of the arrow on the sensor nameplate helps you to install the sensor according to the flow direction (direction of medium flow through the piping).

Vortex meters require a fully developed flow profile as a prerequisite for correct volume flow measurement. Therefore, please note the following:

Orientation		Compact version	Remote version
A	Vertical orientation	✓ ✓ ¹⁾	✓ ✓
B	Horizontal orientation, transmitter head up	✓ ✓ ^{2) 3)}	✓ ✓
C	Horizontal orientation, transmitter head down	✓ ✓ ^{4) 5)}	✓ ✓
D	Horizontal orientation, transmitter head at side	✓ ✓ ⁴⁾	✓ ✓

- 1) In the case of liquids, there should be upward flow in vertical pipes to avoid partial pipe filling (Fig. A). Disruption in flow measurement! In the case of vertical orientation and downward flowing liquid, the pipe always needs to be completely filled to ensure correct liquid flow measurement.
- 2) Danger of electronics overheating! If the fluid temperature is ≥ 200 °C (392 °F), orientation B is not permitted for the wafer version (EF200W-C) with nominal diameters of DN 100 (4") and DN 150 (6").
- 3) In the case of hot media (e.g. steam or fluid temperature (TM) ≥ 200 °C (392 °F): orientation C or D
- 4) In the case of very cold media (e.g. liquid nitrogen): orientation B or D
- 5) For "wet steam detection/measurement" option: orientation C

Pressure measuring cell

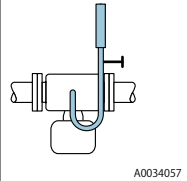
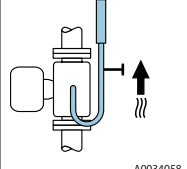
Steam pressure measurement		Option DA	
E	<ul style="list-style-type: none"> • With the transmitter installed at the bottom or at the side • Protection against rising heat 	 <p>A0034057</p>	✓ ✓
F	<ul style="list-style-type: none"> • Reduction in temperature to almost ambient temperature due to siphon¹⁾ 	 <p>A0034058</p>	✓ ✓

1) Note max. permitted ambient temperature of transmitter → See 6.1.2

Minimum spacing and cable length

Order code for "Sensor version", option "mass"

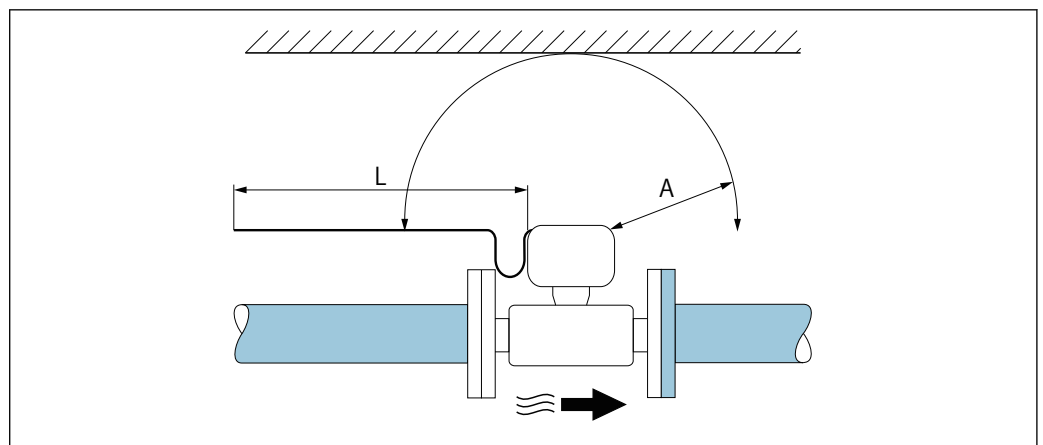

- A Minimum spacing in all directions
- L Required cable length

The following dimensions must be observed to guarantee problem-free access to the device for service purposes:

- A = 100 mm (3.94 in)
- L = L + 150 mm (5.91 in)

Inlet and outlet runs

To attain the specified level of accuracy of the measuring device, the inlet and outlet runs mentioned below must be maintained at the very minimum.

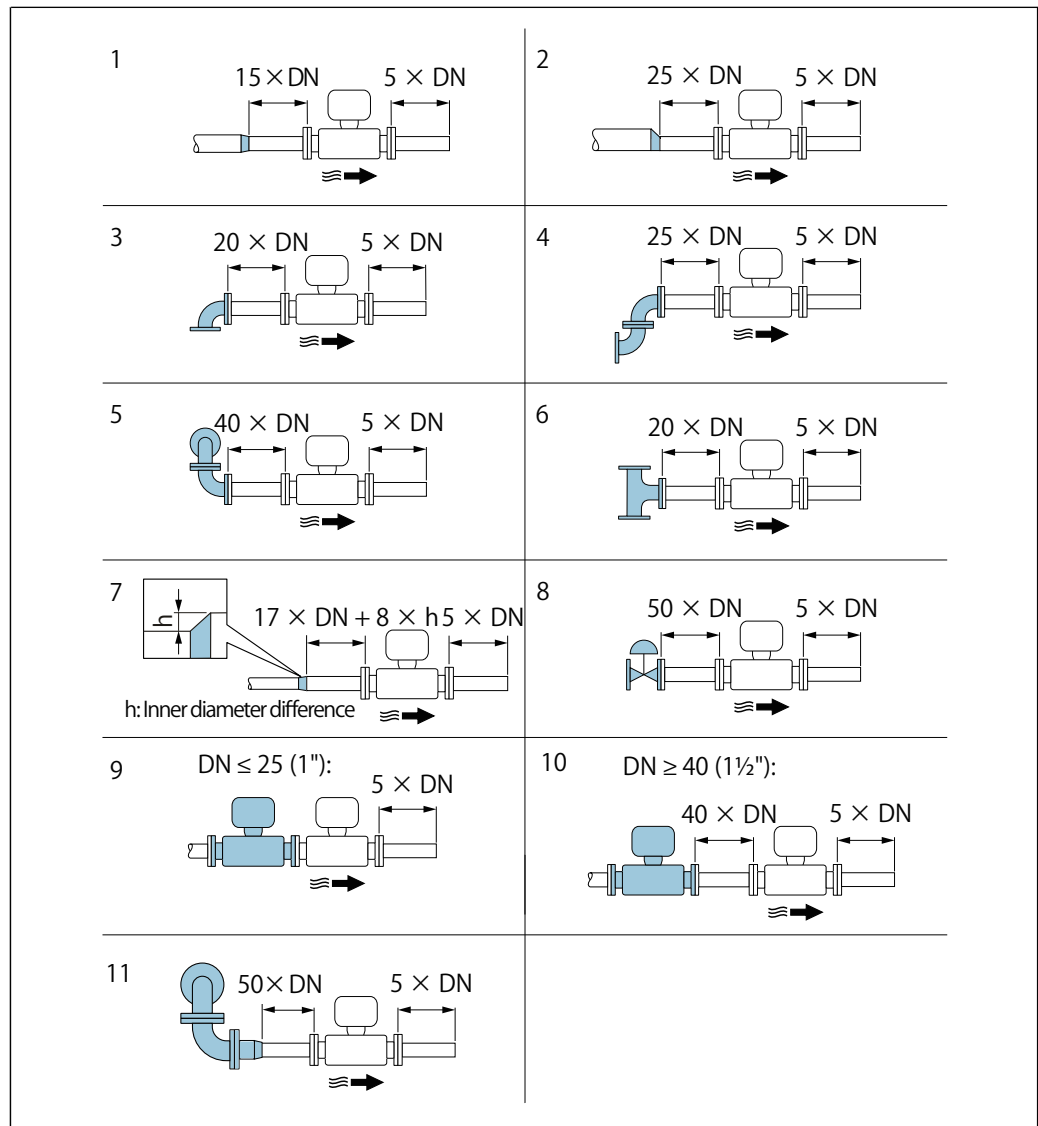

A0019189

Minimum inlet and outlet runs with various flow obstructions

- 1 Difference in expansion
- 2 Reduction by one nominal diameter size
- 3 Single elbow (90° elbow)
- 4 Double elbow (2 × 90° elbows, on one plane)
- 5 Double elbow 3D (2 × 90° elbows, opposite, not on one plane)
- 6 T-piece
- 7 Expansion
- 8 Control valve
- 9 Two measuring devices in a row where $DN \leq 25$ (1"): directly flange on flange
- 10 Two measuring devices in a row where $DN \geq 40$ (1½"): for spacing, see graphic
- 11 Combination pipe (double elbow 3D (elbows 2 × 90° elbows, not on one plane) + reducer, etc.)

- i** • If there are several flow disturbances present, the longest specified inlet run must be maintained.
- If the required inlet runs cannot be observed, it is possible to install a specially designed flow conditioner → See 6.1.1

Flow conditioner

If the inlet runs cannot be observed, the use of a flow conditioner is recommended.

The flow conditioner is fitted between two pipe flanges and centered by the mounting bolts. Generally this reduces the inlet run needed to $10 \times \text{DN}$ or $13 \times \text{DN}$ with full accuracy.

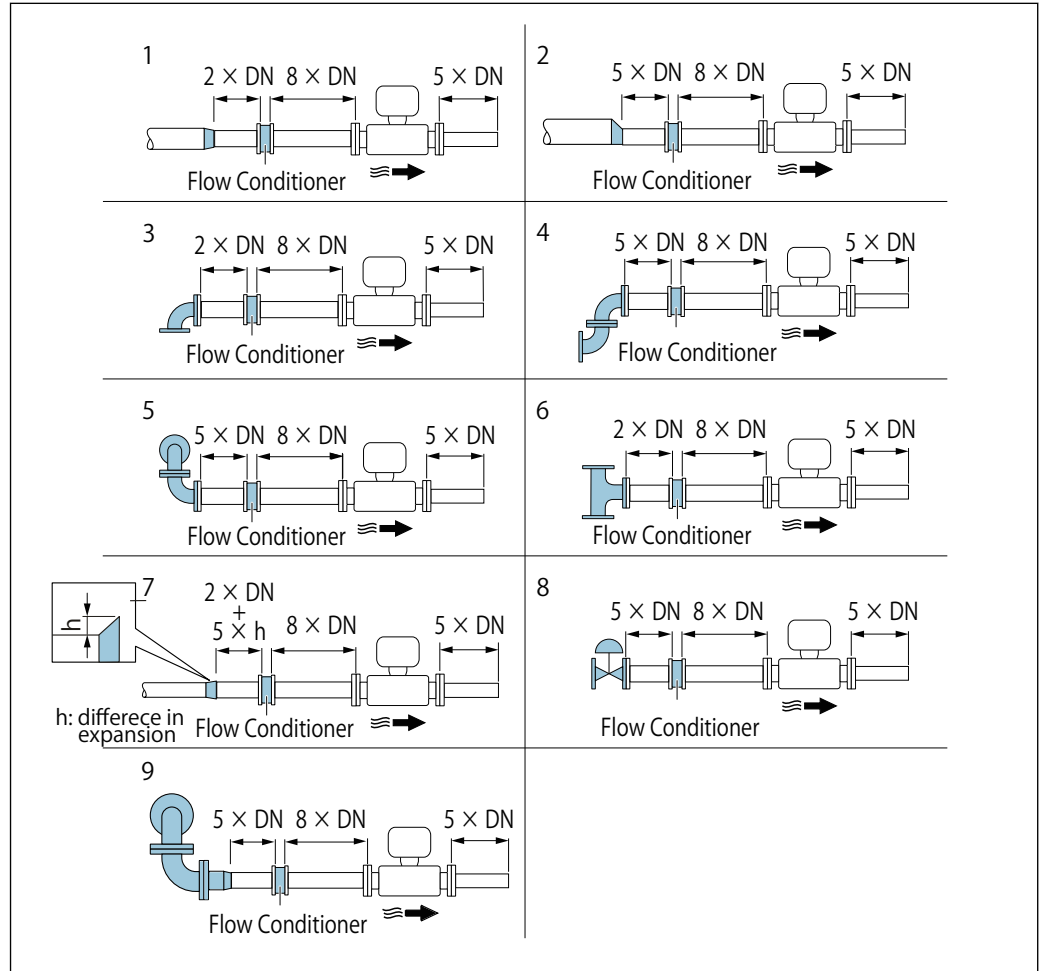

Minimum inlet and outlet runs with various flow obstructions

- 1 Concentric reducer
- 2 Eccentric reducer
- 3 Single elbow (90° elbow)
- 4 Double elbow ($2 \times 90^\circ$ elbows, on one plane)
- 5 Double elbow 3D ($2 \times 90^\circ$ elbows, not on one plane)
- 6 T-piece
- 7 Expansion
- 8 Control valve
- 9 Combination pipe (Double elbow 3D ($2 \times 90^\circ$ elbows, opposite, not on one lane) + reducer, etc.)

The pressure loss for flow conditioners is calculated as follows: $\Delta p \text{ [mbar]} = 0.0085 \cdot \rho \text{ [kg/m}^3\text{]} \cdot V^2 \text{ [m/s]}$

Example for steam

$p = 10 \text{ bar abs.}$

$t = 240 \text{ }^\circ\text{C} \rightarrow \rho = 4.39 \text{ kg/m}^3$

$v = 40 \text{ m/s}$

$\Delta p = 0.0085 \cdot 4.39 \cdot 40^2 = 59.7 \text{ mbar}$

Example for H₂O condensate (80°C)

$\rho = 965 \text{ kg/m}^3$

$v = 2.5 \text{ m/s}$

$\Delta p = 0.0085 \cdot 965 \cdot 2.5^2 = 51.3 \text{ mbar}$

ρ : density of the process medium

v : average flow velocity

abs. = absolute



For the dimensions of the flow conditioner, see the "Technical Information" document, "Mechanical construction" section

Outlet runs when installing external devices

If installing an external device, observe the specified distance.

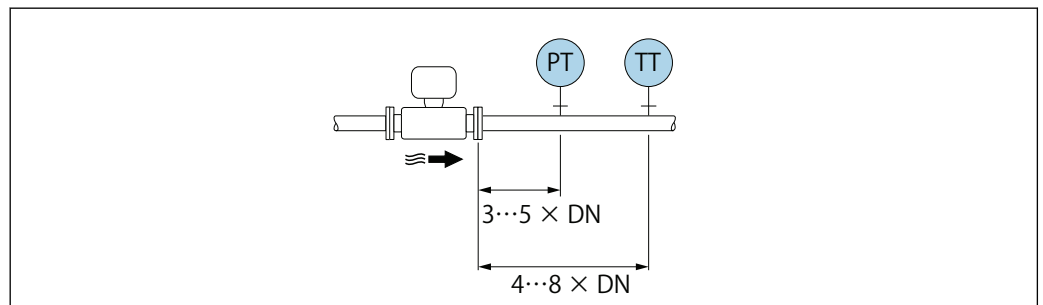

A0019205

PT Pressure

TT Temperature device

Installation dimensions



For the dimensions and installation lengths of the device, see the "Technical Information" document, "Mechanical construction" section.

6.1.2 Environment and process requirements

Ambient temperature range

Compact version

Measuring device	-40 to +80 °C (-40 to +176 °F)
Local display	-40 to +70 °C (-40 to +158 °F) ¹⁾

- 1) At temperatures < -20 °C (-4 °F), depending on the physical characteristics involved, it may no longer be possible to read the liquid crystal display.

Remote version

Transmitter	-40 to +80 °C (-40 to +176 °F)
Sensor	-40 to +85 °C (-40 to +185 °F)
Local display	-40 to +70 °C (-40 to +158 °F) ¹⁾

- 1) At temperatures < -20 °C (-4 °F), depending on the physical characteristics involved, it may no longer be possible to read the liquid crystal display.

- If operating outdoors:
Avoid direct sunlight, particularly in warm climatic regions.

 You can order a weather protection cover from TLV. → See 15.1.1

Thermal insulation

For optimum temperature measurement and mass calculation, heat transfer at the sensor must be avoided for some fluids. This can be ensured by installing thermal insulation. A wide range of materials can be used for the required insulation.

This applies for:

- Compact version
- Remote sensor version

The maximum insulation height permitted is illustrated in the diagram:

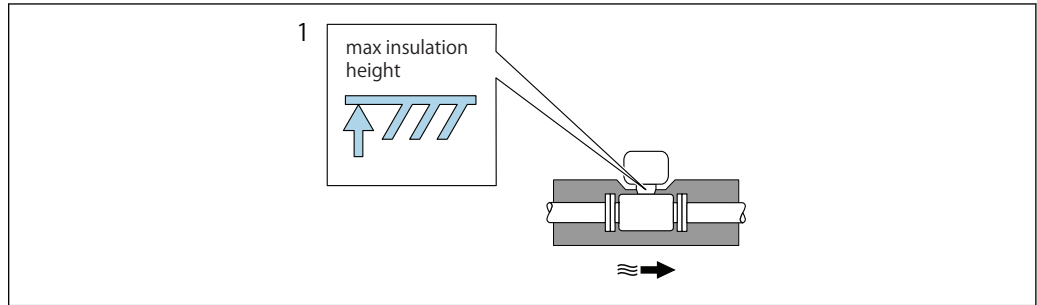

A0019212

1 Maximum insulation height

- ▶ When insulating, ensure that a sufficiently large area of the housing support remains exposed.

The uncovered part serves as a radiator and protects the electronics from overheating and excessive cooling.

NOTICE

Electronics overheating on account of thermal insulation!

- ▶ Observe the maximum permitted insulation height of the transmitter neck so that the transmitter head and/or the connection housing of the remote version is completely free.
- ▶ Observe information on the permissible temperature ranges.
- ▶ Note that a certain orientation might be required, depending on the fluid temperature.

6.1.3 Ensuring accurate measurements

Installing the separator

In some cases where steam is mixed with condensate, it may not be possible to obtain accurate flow rate measurements.

To remove these causes for concern about flow rate measurements, it is recommended to install a separator upstream of the flowmeter.

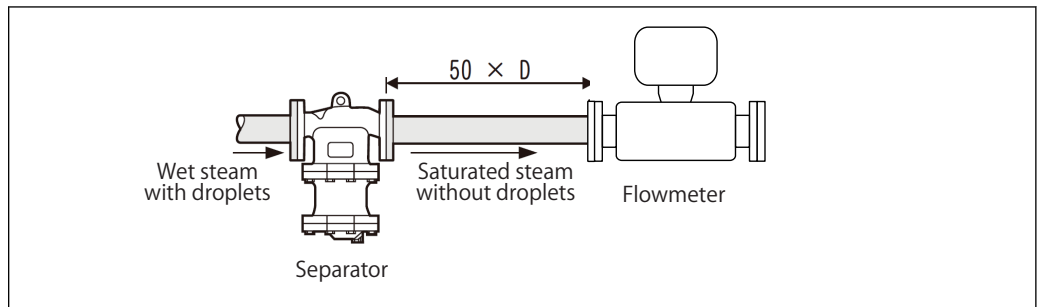

6.2 Mounting the measuring device

6.2.1 Required tools

For transmitter

- For turning the transmitter housing: Open-ended wrench 8 mm
- For opening the securing clamps: Allen key 3 mm

For sensor

For flanges and other process connections: Corresponding mounting tools

6.2.2 Preparing the measuring device

1. Remove all remaining transport packaging.
2. Remove any protective covers or protective caps present from the sensor.
3. Remove stick-on label on the electronics compartment cover.

6.2.3 Mounting the sensor



Danger due to improper process sealing!

- ▶ Ensure that the inside diameters of the gaskets are greater than or equal to that of the process connections and piping.
 - ▶ Ensure that the gaskets are clean and undamaged.
 - ▶ Install the gaskets correctly.
1. Ensure that the direction of the arrow on the sensor matches the flow direction of the medium.
 2. To ensure compliance with device specifications, install the measuring device between the pipe flanges in a way that it is centered in the measurement section.
 3. Install the measuring device or turn the transmitter housing so that the cable entries do not point upwards.

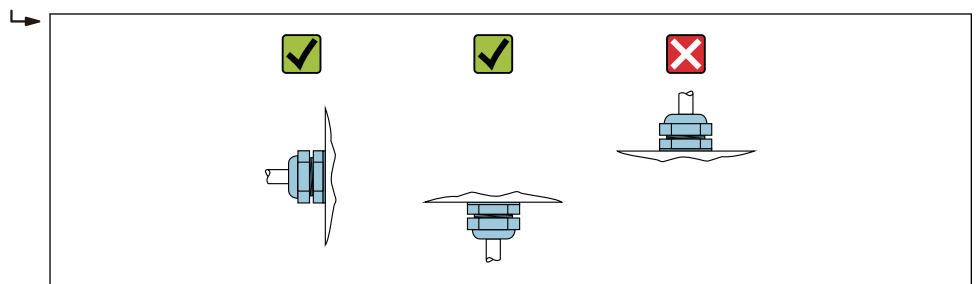

A0029263

6.2.4 Mounting the pressure measuring unit

Preparation

1. Prior to mounting the pressure measuring unit, install the measuring device in the pipe.
2. When mounting the pressure measuring unit, use only the seal provided. The use of a different sealing material is not permitted.

Removing the blind flange

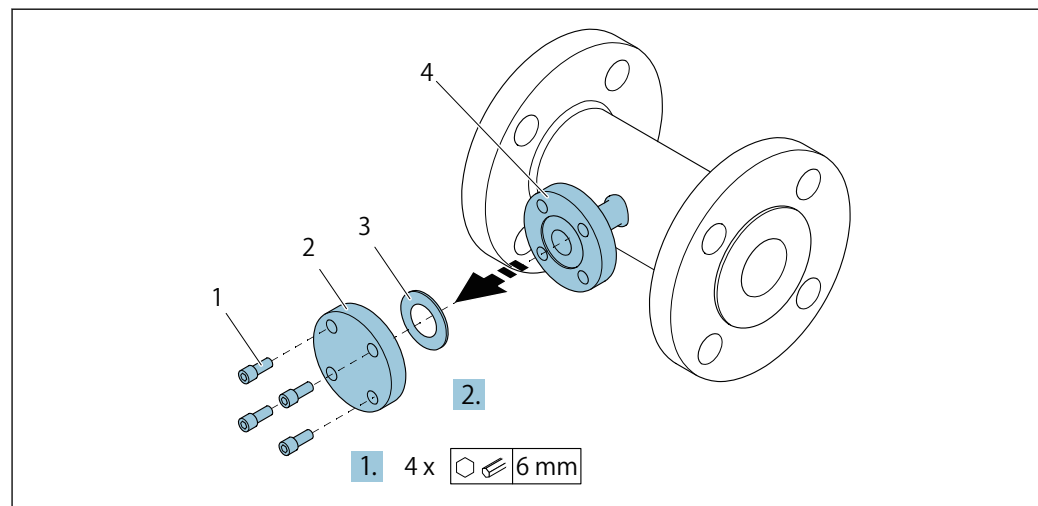

A0034355

- 1 Mounting screws
- 2 blind flange
- 3 Seal
- 4 Flange connection on sensor side

NOTICE

When replacing the seal following commissioning, fluid may escape when the flange connection is opened!

- ▶ Ensure that the measuring device is not under pressure.
 - ▶ Ensure that there is no fluid in the measuring device.
1. Release the mounting screws on the blind flange.
 - ↳ The screws are needed again to mount the pressure measuring unit.
 2. Remove the internal seal.

Mounting the pressure measuring unit

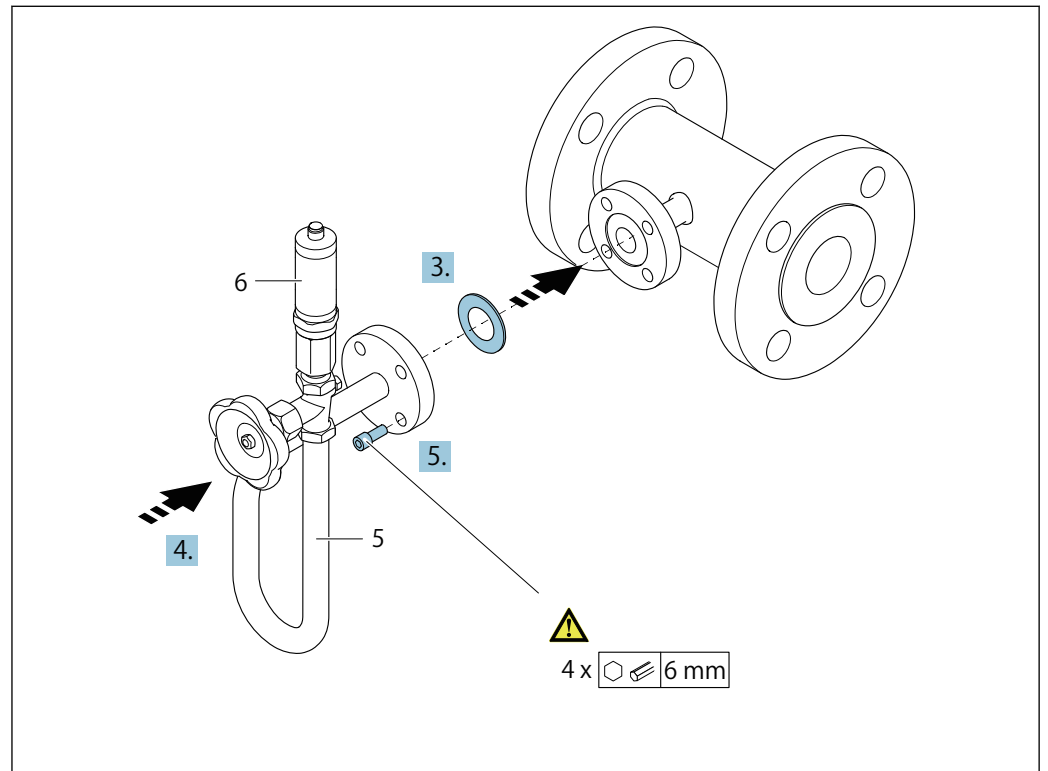

A0035442

- 5 Siphon
6 Pressure measuring cell

3. **NOTICE**

Damage to seal!

The seal is made of expanded graphite. It can therefore be used only once. If a coupling is released, a new seal must be installed.

- Use the additional seals provided. If necessary, these can be ordered as separate spare parts at a later stage.

Insert the enclosed seal into the groove of the flange connection on the sensor side.

4. Align the flange connection on the pressure measuring unit and tighten the screws by hand.
5. Tighten the screws with a torque wrench in three steps.
- ↳ 1. 10 Nm in criss-cross sequence
 - 2. 15 Nm in criss-cross sequence
 - 3. 15 Nm in circular sequence

Connecting the pressure measuring unit

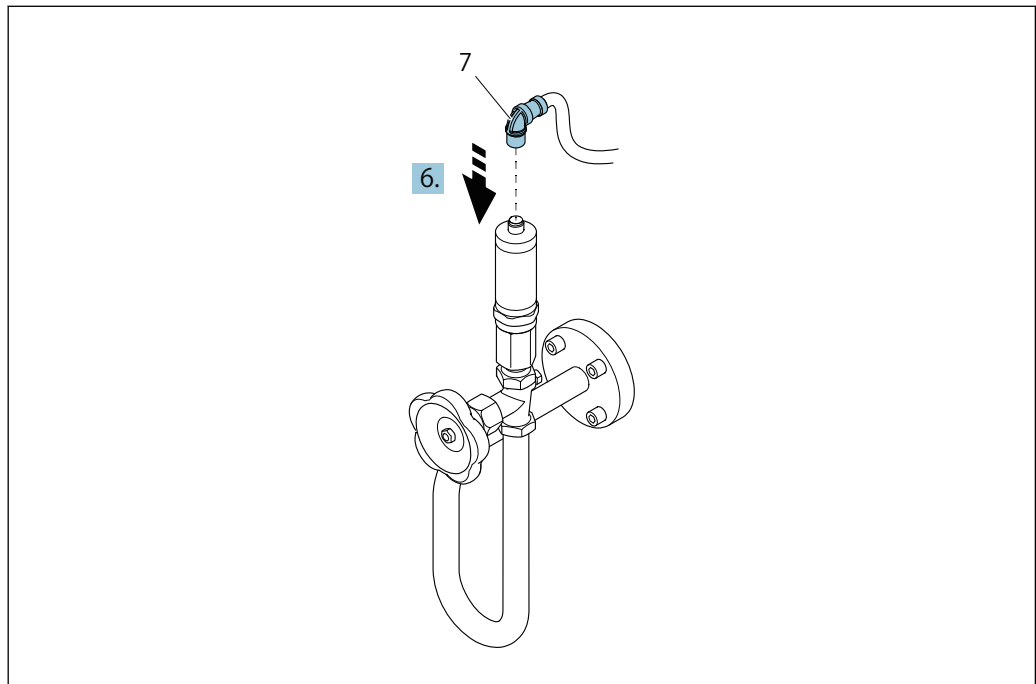

A0035443

7 Device plug

6. Insert the plug for electrical connection of the pressure measuring cell and screw into place.

6.2.5 Mounting the transmitter of the remote version

CAUTION

Ambient temperature too high!

Danger of electronics overheating and housing deformation.

- ▶ Do not exceed the permitted maximum ambient temperature .
- ▶ If operating outdoors: Avoid direct sunlight and exposure to weathering, particularly in warm climatic regions.

CAUTION

Excessive force can damage the housing!

- ▶ Avoid excessive mechanical stress.

The transmitter of the remote version can be mounted in the following ways:

- Wall mounting
- Pipe mounting

Wall mounting

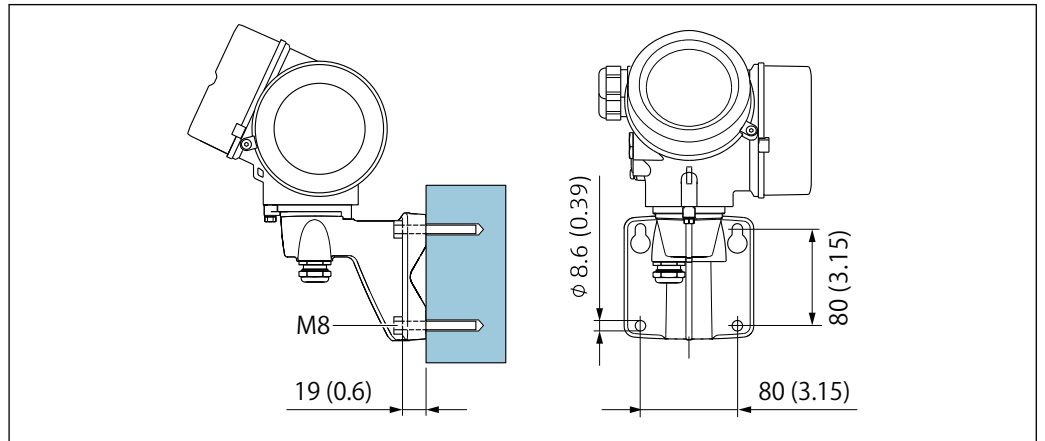

A0033484

mm (in)

Post mounting

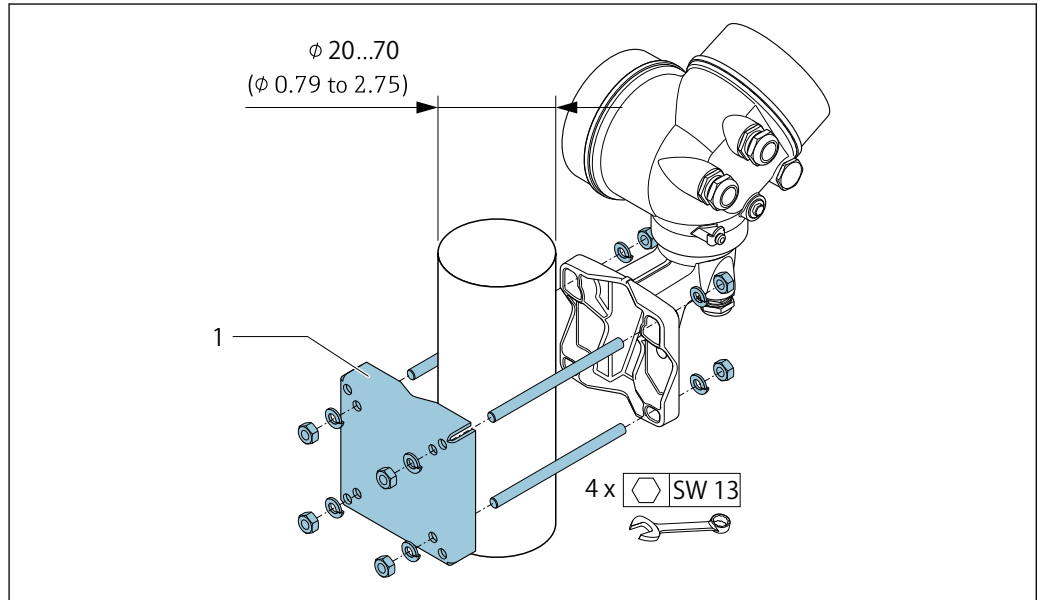

A0033486

mm (in)

6.2.6 Turning the transmitter housing

To provide easier access to the connection compartment or display module, the transmitter housing can be turned.

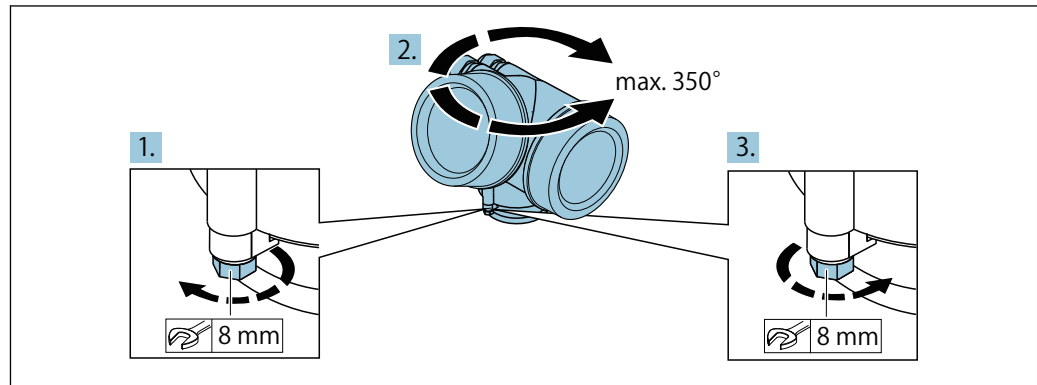

A0032242

1. Release the fixing screw.
2. Turn the housing to the desired position.
3. Firmly tighten the securing screw.

6.2.7 Turning the display module

The display module can be turned to optimize display readability and operability.

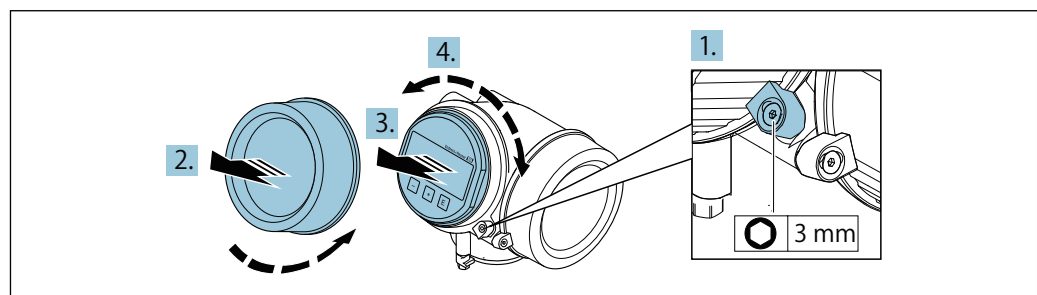

A0032238

1. Loosen the securing clamp of the electronics compartment cover using an Allen key.
2. Unscrew cover of the electronics compartment from the transmitter housing.
3. Optional: pull out the display module with a gentle rotational movement.
4. Turn the display module to the desired position: max. $8 \times 45^\circ$ in every direction.
5. Without display module pulled out:
Allow display module to engage at desired position.
6. With display module pulled out:
Feed the cable into the gap between the housing and main electronics module and plug the display module into the electronics compartment until it engages.
7. Reverse the removal procedure to reassemble the transmitter.

6.3 Post-installation check

Is the device undamaged (visual inspection)?	<input type="checkbox"/>
Does the measuring device conform to the measuring point specifications? For example: <ul style="list-style-type: none"> • Process temperature → See 16.9 • Process pressure (refer to the section on "Pressure-temperature ratings" in the "Technical Information" document → See 16.15) • Ambient temperature • Measuring range → See 16.3 	<input type="checkbox"/>
Has the correct orientation for the sensor been selected? → See 6.1.1 <ul style="list-style-type: none"> • According to sensor type • According to medium temperature • According to medium properties (outgassing, with entrained solids) 	<input type="checkbox"/>
Does the arrow on the sensor nameplate match the direction of flow of the fluid through the piping? → See 6.1.1	<input type="checkbox"/>
Are the measuring point identification and labeling correct (visual inspection)?	<input type="checkbox"/>
Is the device adequately protected against precipitation and direct sunlight?	<input type="checkbox"/>
Are the securing screw and securing clamp tightened securely?	<input type="checkbox"/>
Has the maximum permitted insulation height been observed?	<input type="checkbox"/>
<ul style="list-style-type: none"> • Has the pressure range been observed? → See 16.9 • Was the correct orientation selected? → See 6.1.1 • Is the pressure unit mounted correctly? → See 6.2.4 • Have the pressure gauge valve and the siphon with pressure sensor been mounted using the prescribed seal and the specified torque → See 6.2.4 	<input type="checkbox"/>

7 Electrical connection

7.1 Connection conditions

7.1.1 Required tools

- For cable entries: Use corresponding tools
- For securing clamp: Allen key 3 mm
- Wire stripper
- When using stranded cables: Crimper for wire end ferrule
- For removing cables from terminal: Flat blade screwdriver ≤ 3 mm (0.12 in)

7.1.2 Connecting cable requirements

The connecting cables provided by the customer must fulfill the following requirements.

Electrical safety

In accordance with applicable federal/national regulations.

Permitted temperature range

- The installation guidelines that apply in the country of installation must be observed.
- The cables must be suitable for the minimum and maximum temperatures to be expected.

Signal cable

Current output 4 to 20 mA

A shielded cable is recommended. Observe grounding concept of the plant.

Pulse/frequency/switch output

Standard installation cable is sufficient.

Current input

Standard installation cable is sufficient.

Cable diameter

- Cable glands supplied:
M20 \times 1.5 with cable \varnothing 6 to 12 mm (0.24 to 0.47 in)
- Plug-in spring terminals for device version without integrated overvoltage protection:
wire cross-sections 0.5 to 2.5 mm² (20 to 14 AWG)
- Screw terminals for device version with integrated overvoltage protection: wire cross-sections 0.2 to 2.5 mm² (24 to 14 AWG)

7.1.3 Connecting cable for remote version

Connecting cable

Standard cable	2 × 2 × 0.5 mm ² (22 AWG) PVC cable with common shield (2 pairs, pair-stranded) ¹⁾
Flame resistance	According to DIN EN 60332-1-2
Oil-resistance	According to DIN EN 60811-2-1
Shielding	Galvanized copper-braid, opt. density approx.85 %
Cable length	30 m (98 ft)
Operating temperature	When mounted in a fixed position: -50 to +105 °C (-58 to +221 °F); when cable can move freely: -25 to +105 °C (-13 to +221 °F)

- 1) UV radiation may cause damage to the outer jacket of the cable. Protect the cable from exposure to sun as much as possible.

Connecting cable (option "mass pressure-/temperature-compensated")

Order code for "Sensor version; DSC sensor; measuring tube"

Standard cable	[(3 × 2) + 1] × 0.34 mm ² (22 AWG)PVC cable with common shield (3 pairs, pair-stranded) ¹⁾
Flame resistance	According to DIN EN 60332-1-2
Oil-resistance	According to DIN EN 60811-2-1
Shielding	Galvanized copper-braid, opt. density approx. 85%
Cable length	30 m (98 ft)
Operating temperature	When mounted in a fixed position: -50 to +105 °C (-58 to +221 °F); when cable can move freely: -25 to +105 °C (-13 to +221 °F)

- 1) UV radiation may cause damage to the outer jacket of the cable. Protect the cable from exposure to sun as much as possible.

7.1.4 Terminal assignment

Transmitter

4-20 mA HART connection version with additional inputs and outputs

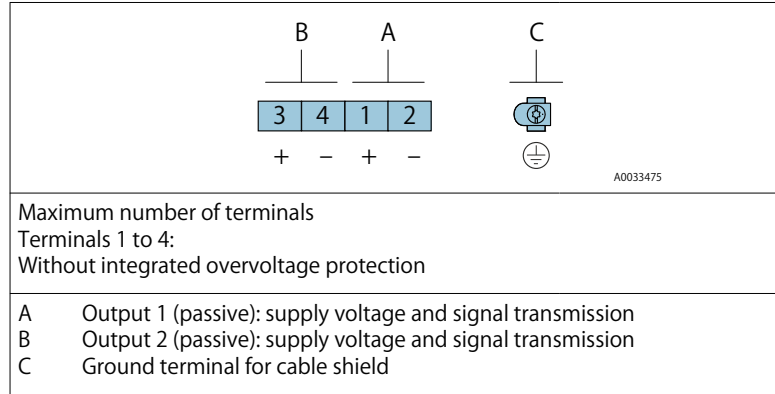

Terminal numbers			
Output 1		Output 2	
1 (+)	2 (-)	3 (+)	4 (-)
4-20 mA HART (passive)		Pulse/frequency/switch output (passive)	

Output 1 must always be used; output 2 is optional.

Connecting cable for remote version

Transmitter and sensor connection housing

In the case of the remote version, the sensor and transmitter are mounted separately from on another and connected by a connecting cable. Connection is performed via the sensor connection housing and the transmitter housing.

Use of connecting cable

Terminals are always used to connect the connecting cable in the sensor connection housing (tightening torques for screws for cable strain relief: 1.2 to 1.7 Nm).

Connecting cable (standard, reinforced)

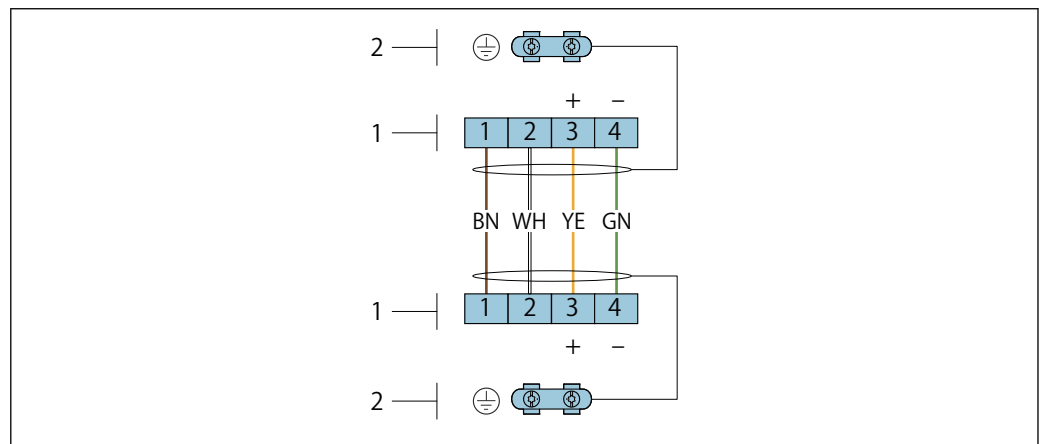

Terminals for connection compartment in the transmitter wall holder and the sensor connection housing

- 1 Terminals for connecting cable
- 2 Grounding via the cable strain relief

Terminal number	Assignment	Cable color Connecting cable
1	Supply voltage	Brown
2	Grounding	White
3	RS485 (+)	Yellow
4	RS485 (-)	Green

Connecting cable (option "mass pressure-/temperature-compensated")

Order code for "Sensor version; DSC sensor; measuring tube", option

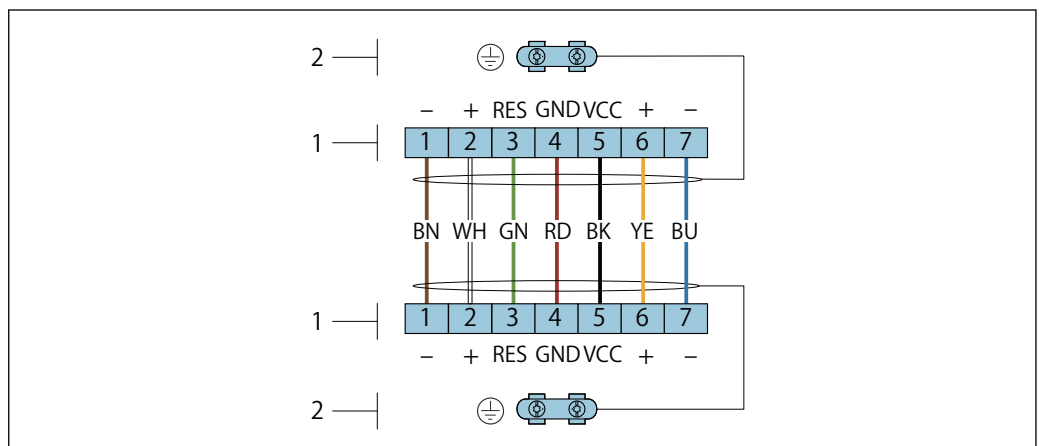

A0034571

Terminals for connection compartment in the transmitter wall holder and the sensor connection housing

- 1 Terminals for connecting cable
- 2 Grounding via the cable strain relief

Terminal number	Assignment	Cable color Connecting cable
1	RS485 (-) DPC	Brown
2	RS485 (+) DPC	White
3	Reset	Green
4	Supply voltage	red
5	Grounding	Black
6	RS485 (+)	Yellow
7	RS485 (-)	Blue

7.1.5 Requirements for the supply unit

Supply voltage

Transmitter

An external power supply is required for each output.

The following supply voltage values apply for the outputs available:

Load

Load for current output: 0 to 500 Ω , depending on the external supply voltage of the power supply unit

Calculation of the maximum load

Depending on the supply voltage of the power supply unit (U_S), the maximum load (R_B) including line resistance must be observed to ensure adequate terminal voltage at the device. In doing so, observe the minimum terminal voltage

- For $U_S = 17.9$ to 18.9 V: $R_B \leq (U_S - 17.9$ V): 0.0036 A
- For $U_S = 18.9$ to 24 V: $R_B \leq (U_S - 13$ V): 0.022 A
- For $U_S = \geq 24$ V: $R_B \leq 500$ Ω

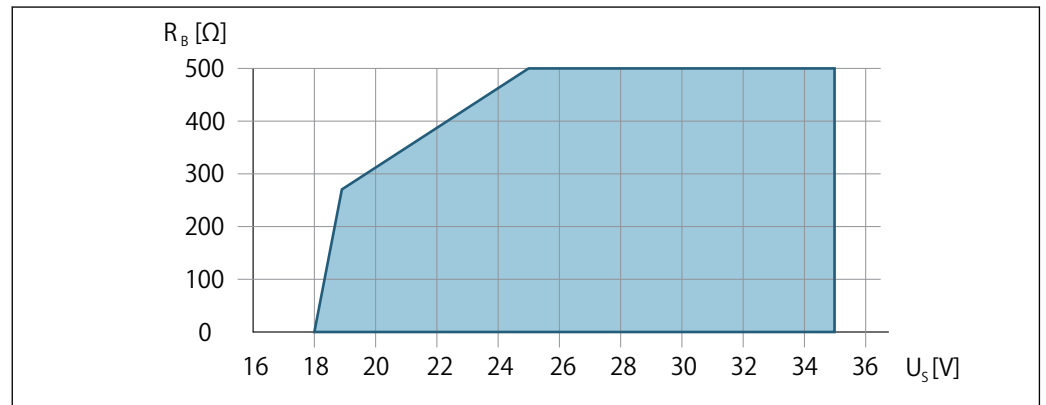

Operating range

A0013563

Sample calculation

Supply voltage of power supply unit: $U_s = 19 \text{ V}$

Maximum load: $R_B \leq (19 \text{ V} - 13 \text{ V}) : 0.022 \text{ A} = 273 \text{ } \Omega$

7.1.6 Preparing the measuring device

Carry out the steps in the following order:

1. Mount the sensor and transmitter.
2. Connection housing, sensor: Connect connecting cable.
3. Transmitter: Connect connecting cable.
4. Transmitter: Connect signal cable and cable for supply voltage.

NOTICE

Insufficient sealing of the housing!

Operational reliability of the measuring device could be compromised.

► Use suitable cable glands corresponding to the degree of protection.

1. Remove dummy plug if present.
2. If the measuring device is supplied without cable glands:
Provide suitable cable gland for corresponding connecting cable.
3. If the measuring device is supplied with cable glands:
Observe requirements for connecting cables → See 7.1.2

7.2 Connecting the measuring device

NOTICE

Limitation of electrical safety due to incorrect connection!

- Have electrical connection work carried out by appropriately trained specialists only.
- Observe applicable federal/national installation codes and regulations.
- Comply with local workplace safety regulations.
- Always connect the protective ground cable \ominus before connecting additional cables.
- For use in potentially explosive atmospheres, observe the information in the device-specific Ex documentation.

7.2.1 Connecting the compact version

Connecting the transmitter

Connection via terminals

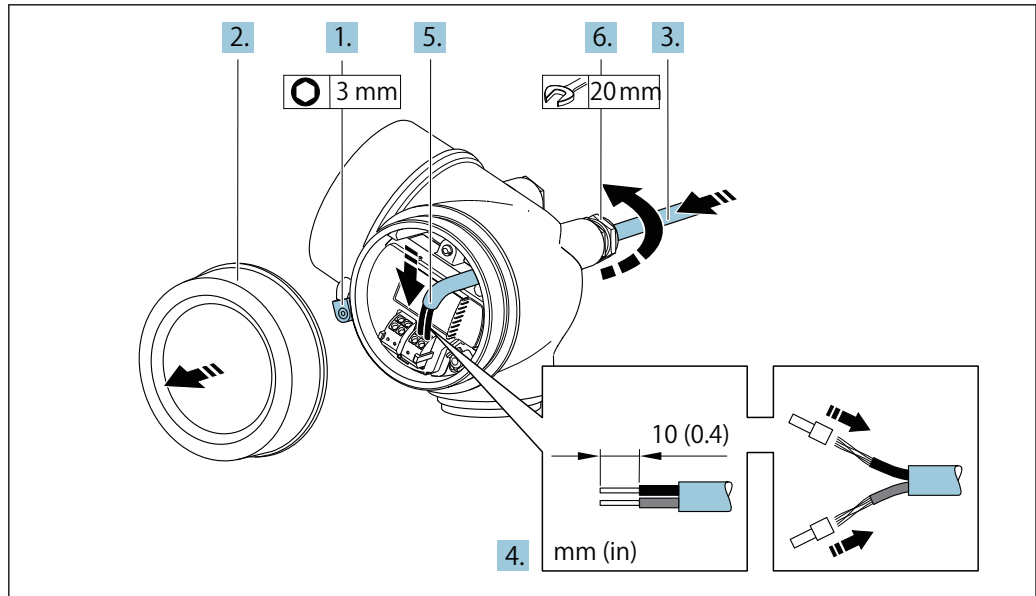

A0032239

1. Loosen the securing clamp of the connection compartment cover.
2. Unscrew the connection compartment cover.
3. Push the cable through the cable entry . To ensure tight sealing, do not remove the sealing ring from the cable entry.
4. Strip the cable and cable ends. In the case of stranded cables, also fit ferrules.
5. Connect cable in accordance with terminal assignment → See 7.1.4. when connecting the cable shielding to the ground clamp, observe the grounding concept of the facility.
6. **⚠ WARNING**
Housing degree of protection may be voided due to insufficient sealing of the housing.
► Screw in the screw without using any lubricant. The threads on the cover are coated with a dry lubricant.

Firmly tighten the cable glands.
7. Reverse the removal procedure to reassemble the transmitter.

Removing a cable

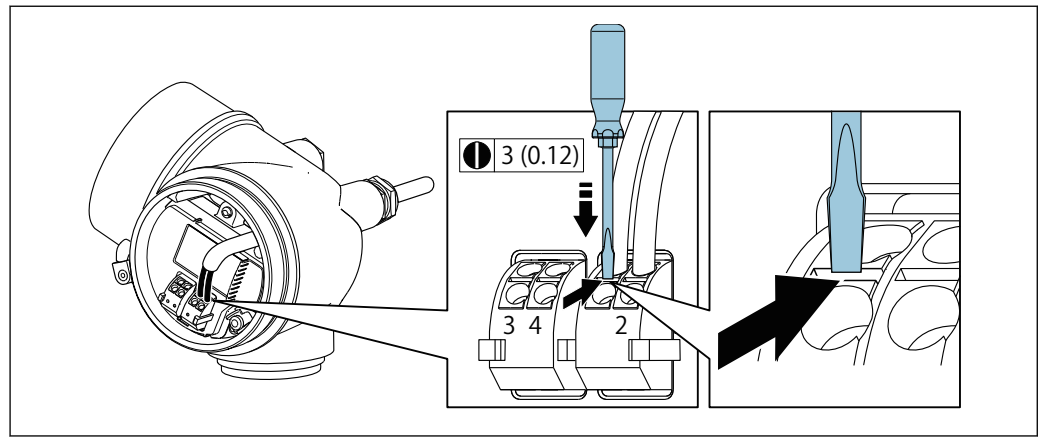

A0032240

- ▶ To remove a cable from the terminal, use a flat-blade screwdriver to push the slot between the two terminal holes while simultaneously pulling the cable end out of the terminal.

7.2.2 Connecting the remote version



Risk of damaging the electronic components!

- ▶ Connect the sensor and transmitter to the same potential equalization.
- ▶ Only connect the sensor to a transmitter with the same serial number.

The following procedure (in the action sequence given) is recommended for the remote version:

1. Mount the sensor and transmitter.
2. Connect the connecting cable for the remote version.
3. Connect the transmitter.



Use of connecting cable

Terminals are always used to connect the connecting cable in the sensor connection housing (tightening torques for screws for cable strain relief: 1.2 to 1.7 Nm).

Connecting the sensor connection housing

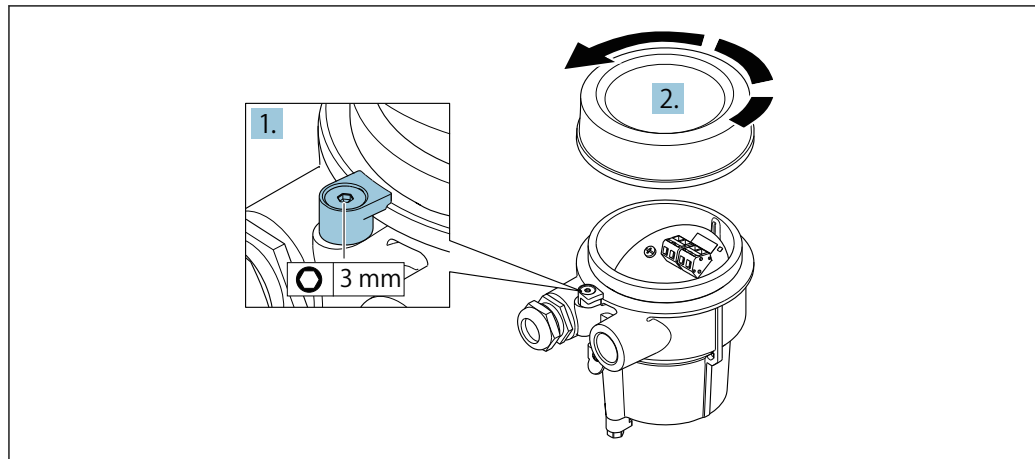

A0034167

1. Loosen the securing clamp.
2. Unscrew the housing cover.

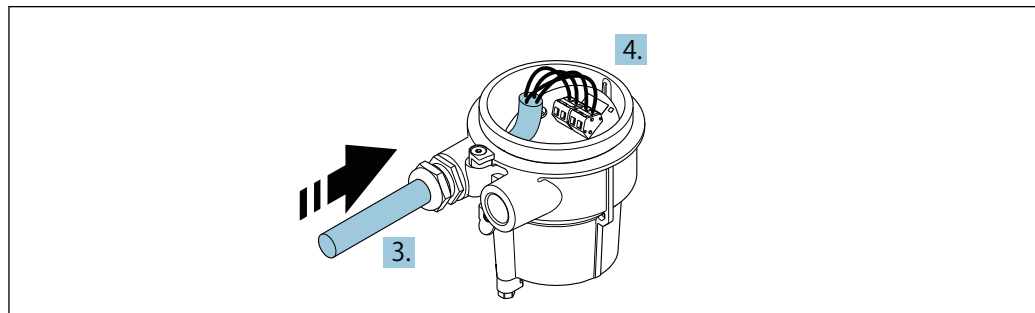

A0034171

Sample graphic

Connecting cable

3. Guide the connecting cable through the cable entry and into the connection housing (if using a connecting cable without an M12 device plug, use the shorter stripped end of the connecting cable).
4. Wire the connecting cable:
 - ↳ Terminal 1 = brown cable
 - Terminal 2 = white cable
 - Terminal 3 = yellow cable
 - Terminal 4 = green cable
5. Connect the cable shield via the cable strain relief.
6. Tighten the screws for the cable strain relief using a torque in the range of 1.2 to 1.7 Nm.
7. Reverse the removal procedure to reassemble the connection housing.

Connecting cable (option "mass pressure-/temperature-compensated")

3. Guide the connecting cable through the cable entry and into the connection housing (if using a connecting cable without an M12 device plug, use the shorter stripped end of the connecting cable).

4. Wire the connecting cable:
 - ↳ Terminal 1 = brown cable
 - Terminal 2 = white cable
 - Terminal 3 = green cable
 - Terminal 4 = red cable
 - Terminal 5 = black cable
 - Terminal 6 = yellow cable
 - Terminal 7 = blue cable
5. Connect the cable shield via the cable strain relief.
6. Tighten the screws for the cable strain relief using a torque in the range of 1.2 to 1.7 Nm.
7. Reverse the removal procedure to reassemble the connection housing.

Connecting transmitter via terminals

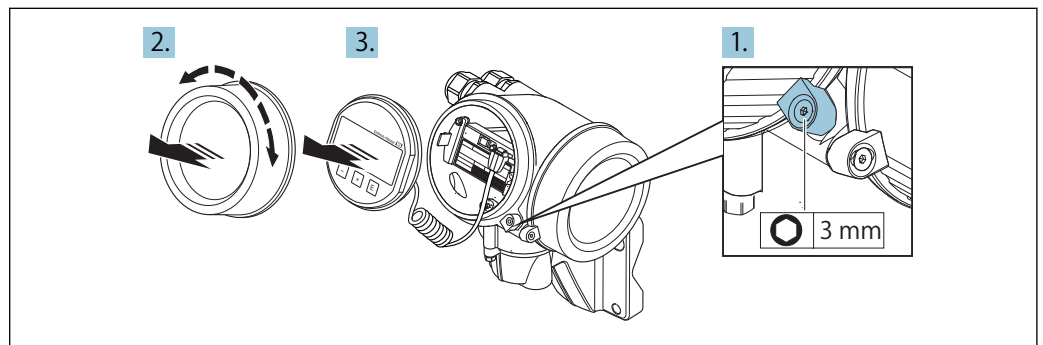

A0034173

1. Loosen the securing clamp of the electronics compartment cover.
2. Unscrew the electronics compartment cover.
3. Pull out the display module with a gentle rotational movement. To make it easier to access the lock switch, attach the display module to the edge of the electronics compartment.

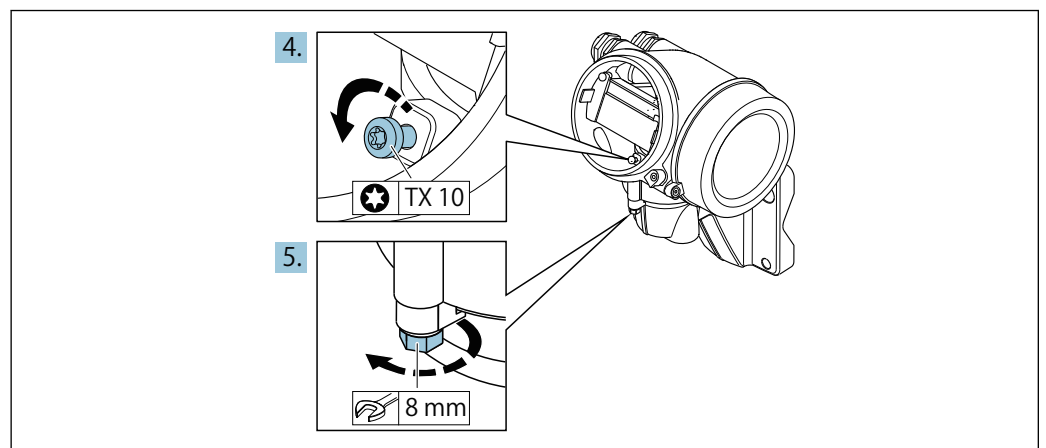

A0034174

4. Loosen the locking screw of the transmitter housing.
5. Loosen the securing clamp of the transmitter housing.

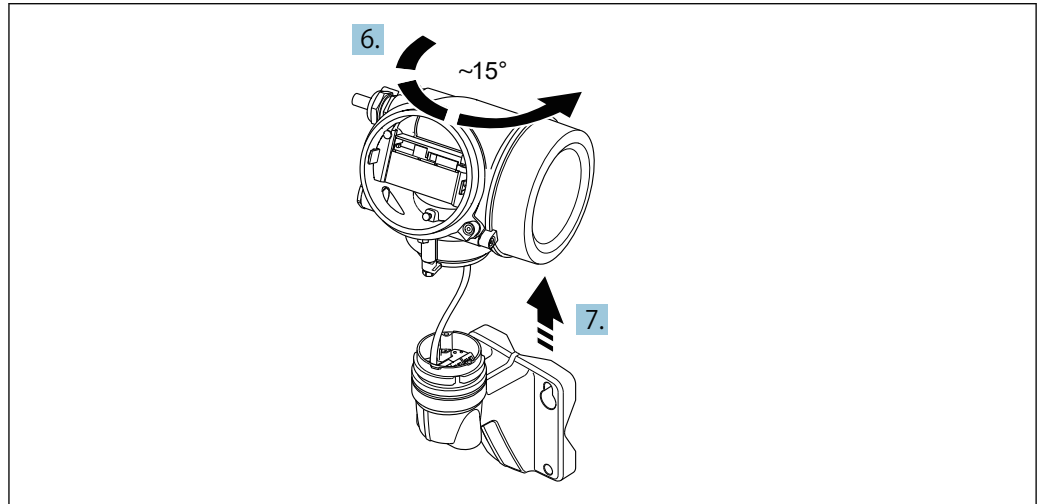

A0034175

Sample graphic

6. Turn the transmitter housing to the right until it reaches the marking.

7. **NOTICE**

The connection board of the wall housing is connected to the electronics board of the transmitter via a signal cable!

► Pay attention to the signal cable when lifting the transmitter housing!

Lift the transmitter housing.

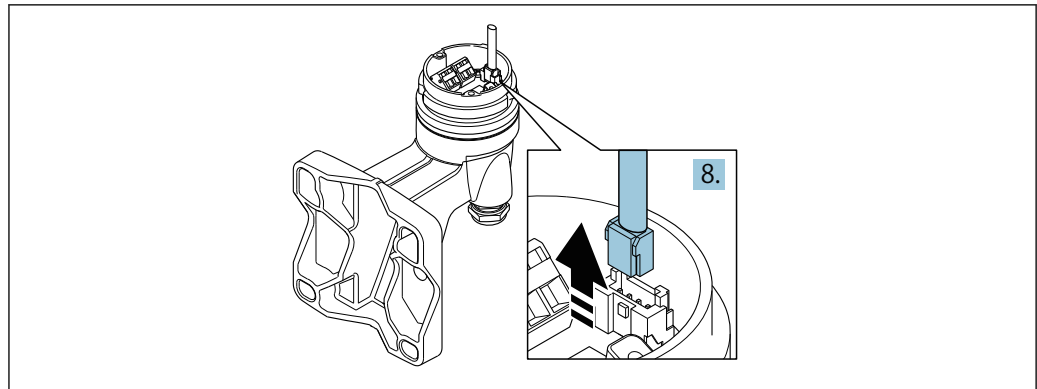

A0034176

Sample graphic

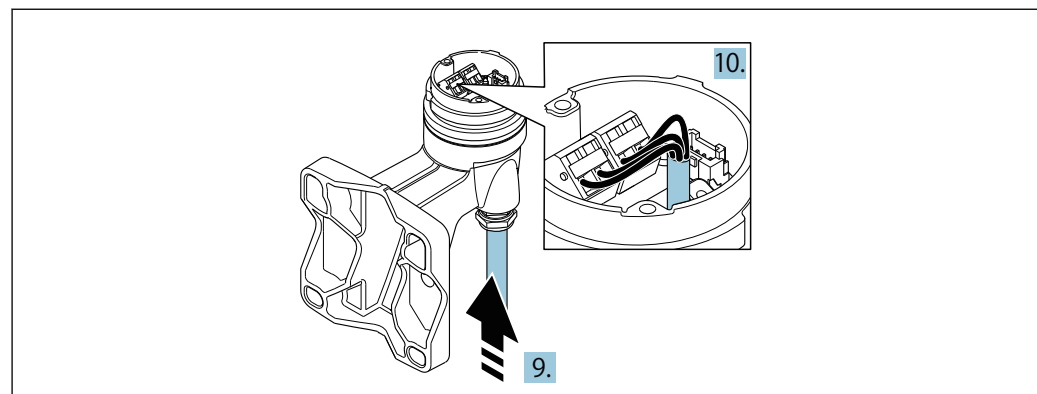

A0034177

Sample graphic

Connecting cable

8. Disconnect the signal cable from the connection board of the wall housing by pressing in the locking clip on the connector. Remove the transmitter housing.
9. Guide the connecting cable through the cable entry and into the connection housing (if using a connecting cable without an M12 device plug, use the shorter stripped end of the connecting cable).
10. Wire the connecting cable:
 - ↳ Terminal 1 = brown cable
 - Terminal 2 = white cable
 - Terminal 3 = yellow cable
 - Terminal 4 = green cable
11. Connect the cable shield via the cable strain relief.
12. Tighten the screws for the cable strain relief using a torque in the range of 1.2 to 1.7 Nm.
13. Reverse the removal procedure to reassemble the transmitter housing.

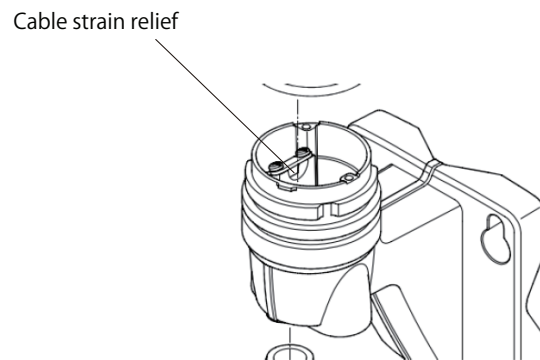

7.2.3 Connecting the connecting cable for the pressure measuring cell

When delivered to the customer, the connecting cable is connected as follows:

- Compact version: to transmitter housing
- Remote version: to sensor connection housing

For connection to sensor and pressure measuring cell:

- ▶ Insert M12 plug of connecting cable into pressure measuring cell and screw into place.

7.2.4 Ensuring potential equalization

Requirements

Please consider the following to ensure correct measurement:

- Same electrical potential for the fluid and sensor
- Remote version: same electrical potential for the sensor and transmitter
- Company-internal grounding concepts
- Pipe material and grounding

7.3 Ensuring the degree of protection

The measuring device fulfills all the requirements for the IP66/67 degree of protection, Type 4X enclosure.

To guarantee IP66/67 degree of protection, Type 4X enclosure, carry out the following steps after the electrical connection:

1. Check that the housing seals are clean and fitted correctly.
2. Dry, clean or replace the seals if necessary.
3. Tighten all housing screws and screw covers.
4. Firmly tighten the cable glands.
5. To ensure that moisture does not enter the cable entry:
Route the cable so that it loops down before the cable entry ("water trap").

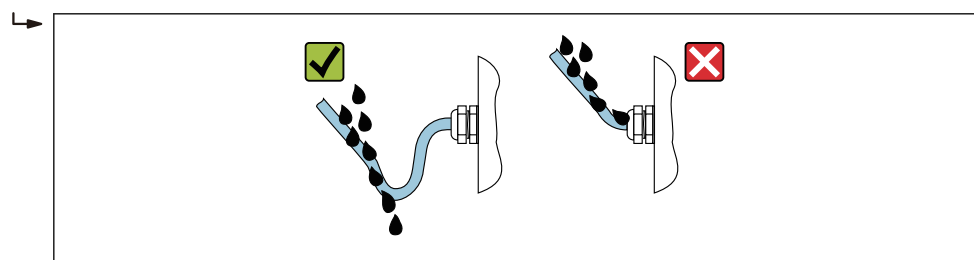

A0029278

6. Insert dummy plugs into unused cable entries.

7.4 Post-connection check

Are cables or the device undamaged (visual inspection)?	<input type="checkbox"/>
Do the cables used meet the requirements? → See 7.1.2	<input type="checkbox"/>
Do the mounted cables have adequate strain relief?	<input type="checkbox"/>
Are all cable glands installed, securely tightened and leak-tight? Cable run with "water trap"? → See 7.3	<input type="checkbox"/>
Depending on the device version, are all the device plugs firmly tightened? → See 7.2	<input type="checkbox"/>
Only for remote version: is the sensor connected to the right transmitter? Check the serial number on the nameplate of the sensor and transmitter.	<input type="checkbox"/>
Does the supply voltage match the specifications on the transmitter nameplate?	<input type="checkbox"/>
Is the terminal assignment correct?	<input type="checkbox"/>
If supply voltage is present, do values appear on the display module?	<input type="checkbox"/>
Are all the housing covers installed and tightened?	<input type="checkbox"/>
Is the securing clamp tightened correctly?	<input type="checkbox"/>
Have the screws for the cable strain relief been tightened using the correct torque? → See 7.2.2	<input type="checkbox"/>
Has the M12 plug of the connecting cable been correctly connected to the pressure measuring cell? → See 7.2.2	<input type="checkbox"/>

7.5 Connecting to TLV EC351 Flow Computer

This device can be used in combination with the flow indicator EC351. The corrected flow rate of fluids whose temperature and pressure change (superheated steam, air) can be displayed by combining with EC351 and a pressure sensor. As for the connection with this device, the output and signal are associated as follows as standard.

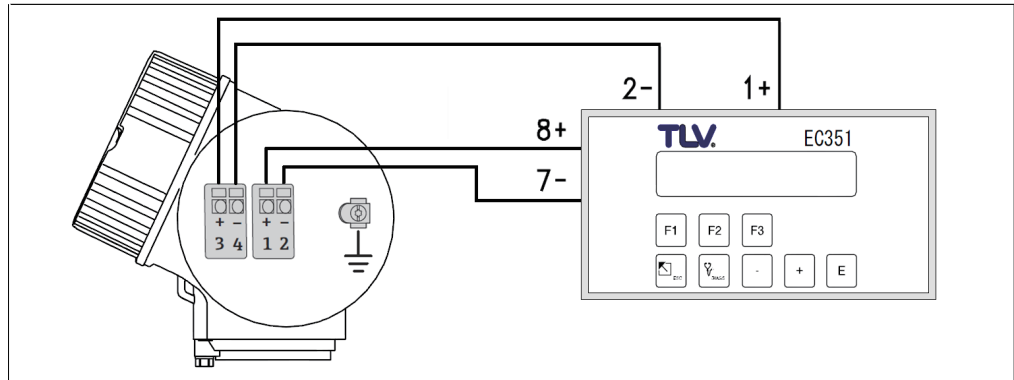

EF200R-C Settings

- Analog output: Temperature (Current output settings → See 10.4.5)
- Pulse output: (pulse/frequency/switch output settings → See 10.4.6)
 - Assign pulse output 1: Pulse output: Mass flowrate (pulse output settings → See 10.4.6)
 - Value per pulse: Set the specified values in the table below according to the size of the device.

Size	25	40	50	80	100	150	200
Value per pulse [L/P]	0.0684	0.3478	0.8551	1.4258	3.1995	5.5420	12.6070

- Pulse width: 5 ms
- Volume unit: L (litre) or dm³ (system units settings → See 10.4.2)

EC351 Settings

- Function group: FLOW INPUT
Function: K-FACTOR
Selection: Set the specified values in the table below according to the size of the device.

Size	25	40	50	80	100	150	200
K-FACTOR [P/I]	14.61988	2.87522	1.16945	0.70136	0.31255	0.18044	0.07932

CAUTION

Flowrate can be displayed on the EC351 without using the EF200-C analog output. Connecting an external correction sensor to EC351 separately is necessary when displaying the value converted to mass flow rate on the EC351.

Connection example when using analog output for data logger and displaying mass flow rate on EC351

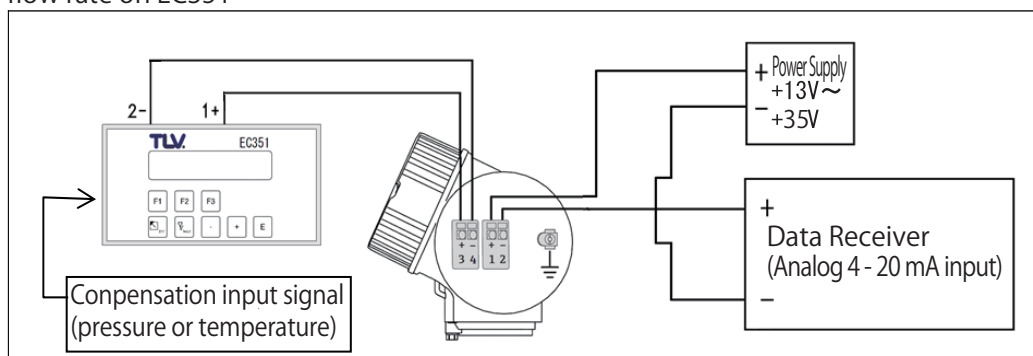

8 Operation options

8.1 Overview of operation options

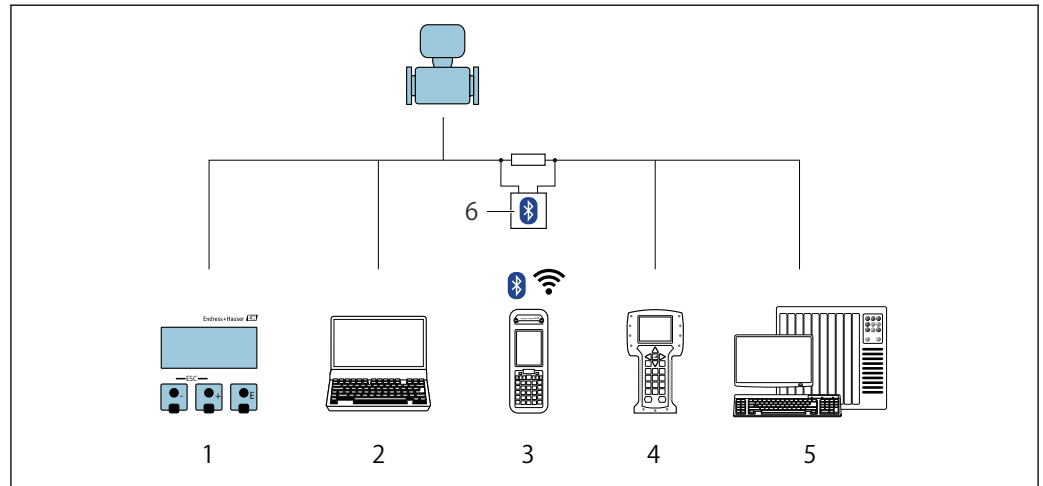

A0032226

- 1 Local operation via display module
- 2 Computer with operating tool
- 3 Field Xpert SFX350 or SFX370
- 4 Field Communicator 475
- 5 Control system (e.g. PLC)
- 6 VIATOR Bluetooth modem with connecting cable

8.2 Structure and function of the operating menu

8.2.1 Structure of the operating menu

 For an overview of the operating menu for experts: "Description of Device Parameters" document supplied with the device

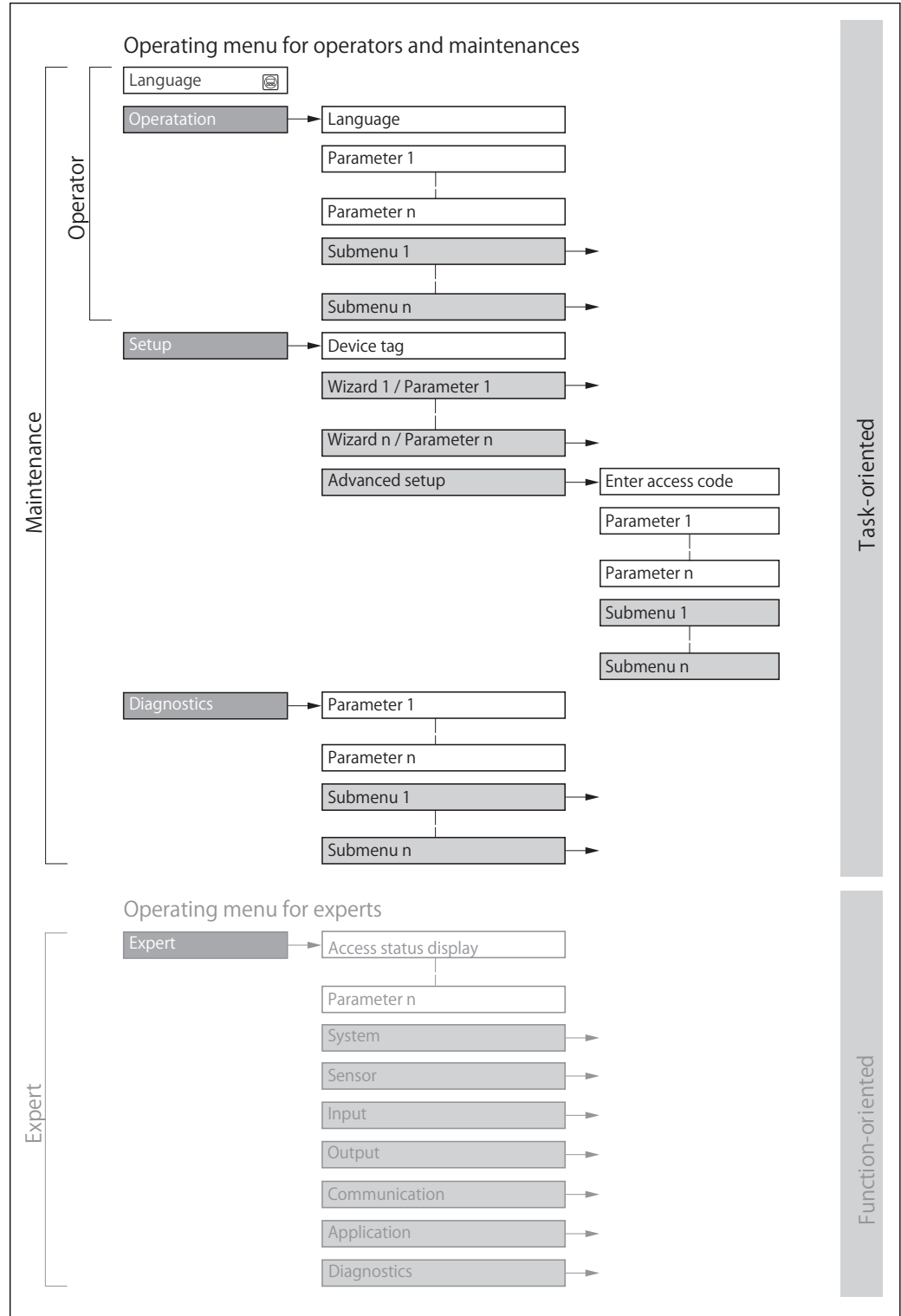

Schematic structure of the operating menu

A0018237-EN

8.2.2 Operating philosophy

The individual parts of the operating menu are assigned to certain user roles (operator, maintenance etc.). Each user role contains typical tasks within the device lifecycle.

Menu/parameter		User role and tasks	Content/meaning
Language	task-oriented	Role "Operator", "Maintenance" Tasks during operation:	<ul style="list-style-type: none"> Defining the operating language
Operation		<ul style="list-style-type: none"> Configuring the operational display Reading measured values 	<ul style="list-style-type: none"> Configuring the operational display (e.g. display format, display contrast) Resetting and controlling totalizers
Setup		"Maintenance" role Commissioning:	<p>Wizards for fast commissioning:</p> <ul style="list-style-type: none"> Setting the system units Defining the medium Configuring the current input Configuring the outputs Configuring the operational display Defining the output conditioning Setting the low flow cut off <p>Advanced setup</p> <ul style="list-style-type: none"> For more customized configuration of the measurement (adaptation to special measuring conditions) Configuration of totalizers Administration (define access code, reset measuring device)
Diagnostics		"Maintenance" role Fault elimination:	<p>Contains all parameters for error detection and analyzing process and device errors:</p> <ul style="list-style-type: none"> Diagnostic list Contains up to 5 currently pending diagnostic messages. Event logbook Contains event messages that have occurred. Device information Contains information for identifying the device. Measured values Contains all current measured values. Heartbeat The functionality of the device is checked on demand and the reverification sults are documented. Simulation Is used to simulate measured values or output values.
Expert	function-oriented	Tasks that require detailed knowledge of the function of the device:	<p>Contains all the parameters of the device and makes it possible to access these parameters directly using an access code. The structure of this menu is based on the function blocks of the device:</p> <ul style="list-style-type: none"> System Contains all higher-order device parameters which do not concern the measurement or the communication interface. Sensor Configuration of the measurement. Input Configuration of the input. Output Configuration of the outputs. Communication Configuration of the digital communication interface. Application Configuration of the functions that go beyond the actual measurement (e.g. totalizer). Diagnostics Error detection and analysis of process and device errors and for device simulation and Heartbeat Technology.

8.3 Access to the operating menu via the local display

8.3.1 Operational display

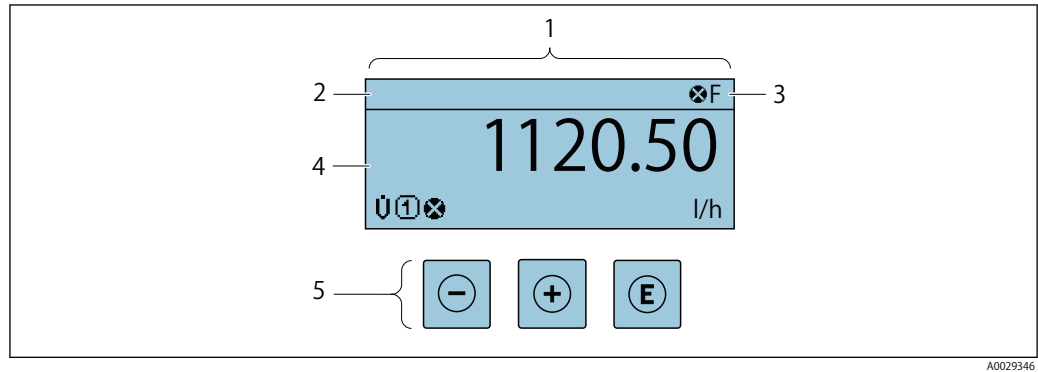

- 1 Operational display
- 2 Device tag→ See 10.4.1
- 3 Status area
- 4 Display area for measured values (4-line)
- 5 Operating elements→ See 8.3.4

Status area

The following symbols appear in the status area of the operational display at the top right:

- Status signals→ See 12.2.1
 - F: Failure
 - C: Function check
 - S: Out of specification
 - M: Maintenance required
- Diagnostic behavior→ See 12.2.1
 - : Alarm
 - : Warning
- : Locking (the device is locked via the hardware)
- : Communication (communication via remote operation is active)

Display area

In the display area, each measured value is prefaced by certain symbol types for further description:

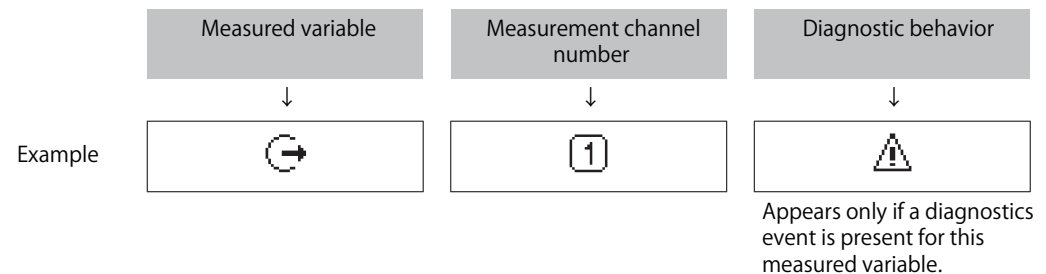

Measured values

Symbol	Meaning
	Volume flow

	<p>Totalizer</p> <p> The measurement channel number indicates which of the three totalizers is displayed.</p>
	<p>Output</p> <p> The measurement channel number indicates which of the two current outputs is displayed.</p>

Measurement channel numbers

Symbol	Meaning
	Measurement channel 1 to 4

The measurement channel number is displayed only if more than one channel is present for the same measured variable type (e.g. Totalizer 1 to 3).

Diagnostic behavior

The diagnostic behavior pertains to a diagnostic event that is relevant to the displayed measured variable. For information on the symbols → See 12.2.1

The number and display format of the measured values can be configured via the Format display parameter (→ See 10.4.7).

8.3.2 Navigation view

In the submenu	In the wizard
<p style="text-align: right; font-size: small;">A0013993-EN</p>	<p style="text-align: right; font-size: small;">A0016327-EN</p>
<p>1 Navigation view 2 Navigation path to current position 3 Status area 4 Display area for navigation 5 Operating elements → See 8.3.4</p>	

Navigation path

The navigation path - displayed at the top left in the navigation view - consists of the following elements:

<ul style="list-style-type: none"> • In the submenu: Display symbol for menu • In the wizard: Display symbol for wizard 	<p>Omission symbol for operating menu levels in between</p>	<p>Name of current</p> <ul style="list-style-type: none"> • Submenu • Wizard • Parameters
↓	↓	↓
<p>Examples</p> <div style="border: 1px solid black; width: 100px; height: 30px; margin: 5px auto; text-align: center;"> </div> <div style="border: 1px solid black; width: 100px; height: 30px; margin: 5px auto; text-align: center;"> </div>	<div style="border: 1px solid black; width: 100px; height: 30px; margin: 5px auto; text-align: center;"> / .. / </div> <div style="border: 1px solid black; width: 100px; height: 30px; margin: 5px auto; text-align: center;"> / .. / </div>	<div style="border: 1px solid black; width: 100px; height: 30px; margin: 5px auto; text-align: center;"> Display </div> <div style="border: 1px solid black; width: 100px; height: 30px; margin: 5px auto; text-align: center;"> Display </div>

 For more information about the icons in the menu, refer to the "Display area" section → See 8.3.1

Status area





The following appears in the status area of the navigation view in the top right corner:

- In the submenu
 - The direct access code for the parameter you are navigating to (e.g. 0022-1)
 - If a diagnostic event is present, the diagnostic behavior and status signal
- In the wizard
 - If a diagnostic event is present, the diagnostic behavior and status signal





-  • For information on the diagnostic behavior and status signal → See 12.2.1
- For information on the function and entry of the direct access code → See 8.3.6

Display area

Menus

Symbol	Meaning
	Operation Appears: • In the menu next to the "Operation" selection • At the left in the navigation path in the Operation menu
	Setup Appears: • In the menu next to the "Setup" selection • At the left in the navigation path in the Setup menu
	Diagnostics Appears: • In the menu next to the "Diagnostics" selection • At the left in the navigation path in the Diagnostics menu
	Expert Appears: • In the menu next to the "Expert" selection • At the left in the navigation path in the Expert menu



Submenus, wizards, parameters

Symbol	Meaning
	Submenu
	Wizard
	Parameters within a wizard  No display symbol exists for parameters in submenus.

Locking

Symbol	Meaning
	Parameter locked When displayed in front of a parameter name, indicates that the parameter is locked. • By a user-specific access code • By the hardware write protection switch

Wizard operation

Symbol	Meaning
	Switches to the previous parameter.
	Confirms the parameter value and switches to the next parameter.
	Opens the editing view of the parameter.



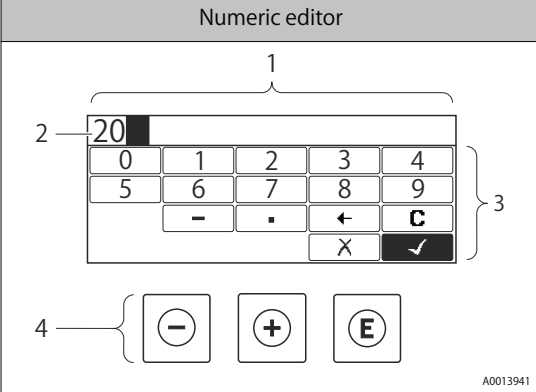
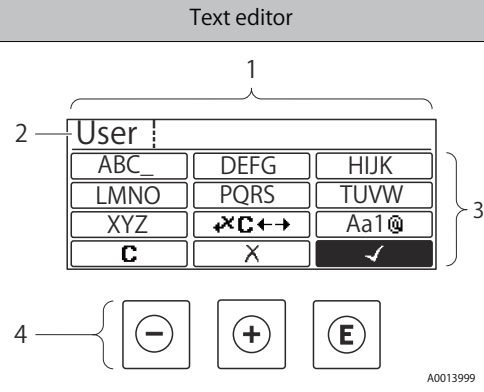



8.3.3 Editing view

Numeric editor	Text editor
	
<p>1 Editing view 2 Display area of the entered values 3 Input mask 4 Operating elements → See 8.3.4</p>	

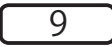
Input mask

The following input symbols are available in the input mask of the numeric and text editor:

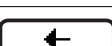
Numeric editor

Symbol	Meaning
	Selection of numbers from 0 to 9.
	
	Inserts decimal separator at the input position.
	Inserts minus sign at the input position.
	Confirms selection.
	Moves the input position one position to the left.
	Exits the input without applying the changes.
	Clears all entered characters.







Text editor

Symbol	Meaning
	Toggle <ul style="list-style-type: none"> • Between upper-case and lower-case letters • For entering numbers • For entering special characters
 ... 	Selection of letters from A to Z.
 ... 	Selection of letters from a to z.
 ... 	Selection of special characters.
	Confirms selection.
	Switches to the selection of the correction tools.
	Exits the input without applying the changes.
	Clears all entered characters.

Correction symbols under

Symbol	Meaning
	Clears all entered characters.
	Moves the input position one position to the right.
	Moves the input position one position to the left.
	Deletes one character immediately to the left of the input position.

8.3.4 Operating elements

Operating key(s)	Meaning
	<p>Minus key</p> <p>In a menu, submenu Moves the selection bar upwards in a picklist.</p> <p>With a Wizard Confirms the parameter value and goes to the previous parameter.</p> <p>With a text and numeric editor In the input screen, moves the selection bar to the left (backwards).</p>
	<p>Plus key</p> <p>In a menu, submenu Moves the selection bar downwards in a picklist.</p> <p>With a Wizard Confirms the parameter value and goes to the next parameter.</p> <p>With a text and numeric editor Moves the selection bar to the right (forwards) in an input screen.</p>
	<p>Enter key</p> <p>For operational display Pressing the key for 2 s opens the context menu.</p> <p>In a menu, submenu</p> <ul style="list-style-type: none"> Pressing the key briefly: <ul style="list-style-type: none"> Opens the selected menu, submenu or parameter. Starts the wizard. If help text is open, closes the help text of the parameter. Pressing the key for 2 s for parameter: <ul style="list-style-type: none"> If present, opens the help text for the function of the parameter. <p>With a Wizard Opens the editing view of the parameter.</p> <p>With a text and numeric editor</p> <ul style="list-style-type: none"> Pressing the key briefly: <ul style="list-style-type: none"> Opens the selected group. Carries out the selected action. Pressing the key for 2 s confirms the edited parameter value.
	<p>Escape key combination (press keys simultaneously)</p> <p>In a menu, submenu</p> <ul style="list-style-type: none"> Pressing the key briefly: <ul style="list-style-type: none"> Exits the current menu level and takes you to the next higher level. If help text is open, closes the help text of the parameter. Pressing the key for 2 s returns you to the operational display ("home position"). <p>With a Wizard Exits the wizard and takes you to the next higher level.</p> <p>With a text and numeric editor Closes the text or numeric editor without applying changes.</p>
	<p>Plus/Enter key combination (press and hold down the keys simultaneously)</p> <p>Increases the contrast (darker setting).</p>
	<p>Minus/Plus/Enter key combination (press the keys simultaneously)</p> <p>For operational display Enables or disables the keypad lock.</p>



8.3.5 Opening the context menu

Using the context menu, the user can call up the following menus quickly and directly from the operational display:

- Setup
- Configuration backup display
- Simulation
- Keylock ON



Calling up and closing the context menu

The user is in the operational display.

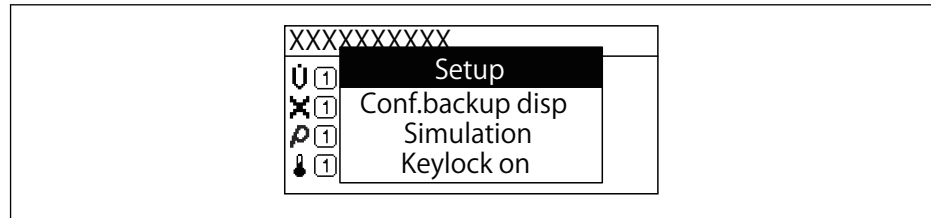

1. Press the  and  keys for longer than 3 seconds.
↳ The context menu opens.



A0034284-EN

2. Press  +  simultaneously.
↳ The context menu is closed and the operational display appears.

Calling up the menu via the context menu

1. Open the context menu.
2. Press  to navigate to the desired menu.
3. Press  to confirm the selection.
↳ The selected menu opens.

8.3.6 Navigating and selecting from list

Different operating elements are used to navigate through the operating menu. The navigation path is displayed on the left in the header. Icons are displayed in front of the individual menus. These icons are also shown in the header during navigation.

i For an explanation of the navigation view with symbols and operating elements → See 8.3.2

Example: Setting the number of displayed measured values to "2 values"

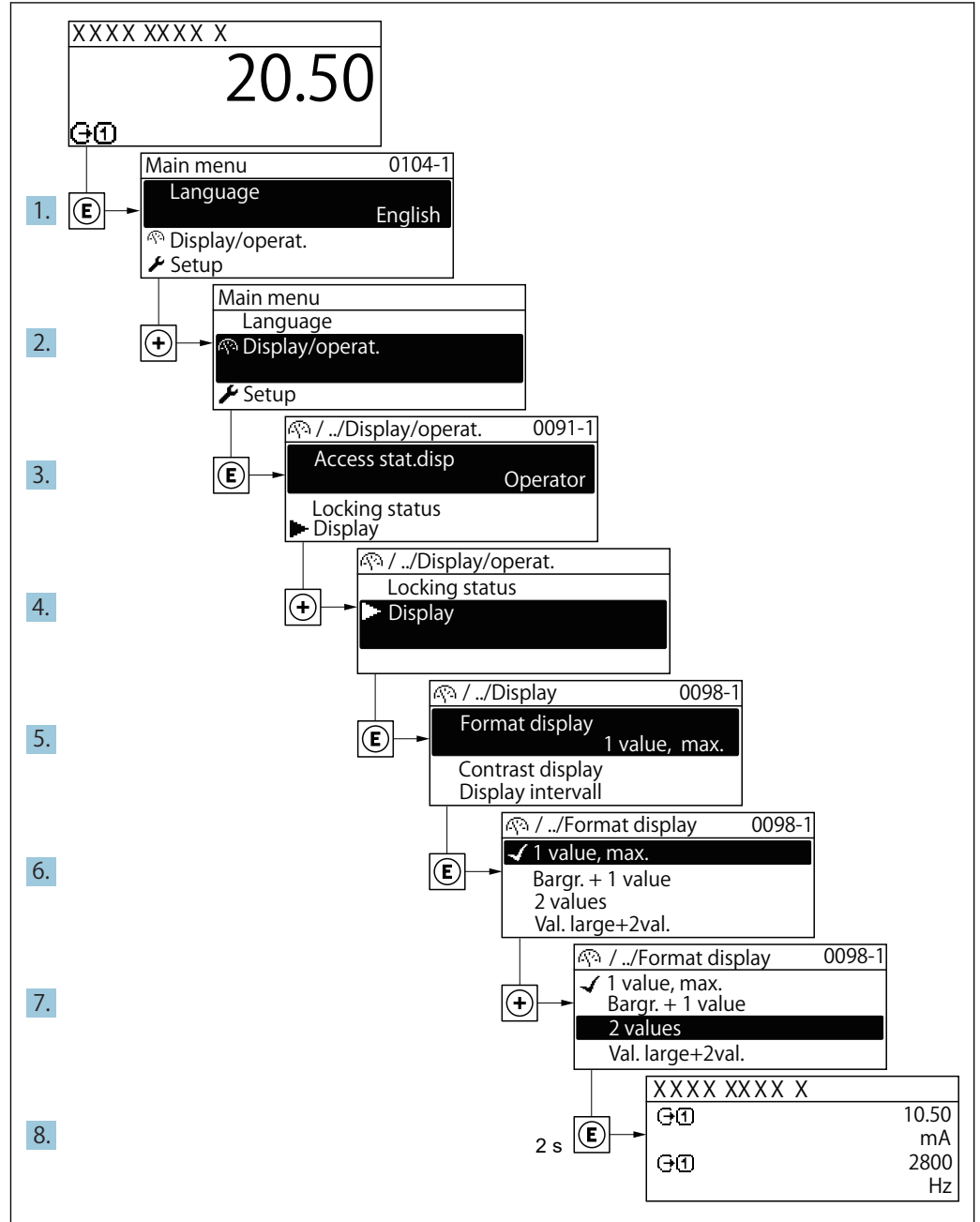

A0029562-EN

8.3.7 Calling the parameter directly

A parameter number is assigned to every parameter to be able to access a parameter directly via the onsite display. Entering this access code in the Direct access parameter calls up the desired parameter directly.

Navigation path
Expert → Direct access

The direct access code consists of a 5-digit number (at maximum) and the channel number, which identifies the channel of a process variable: e.g. 00914-2. In the navigation view, this appears on the right-hand side in the header of the selected parameter.

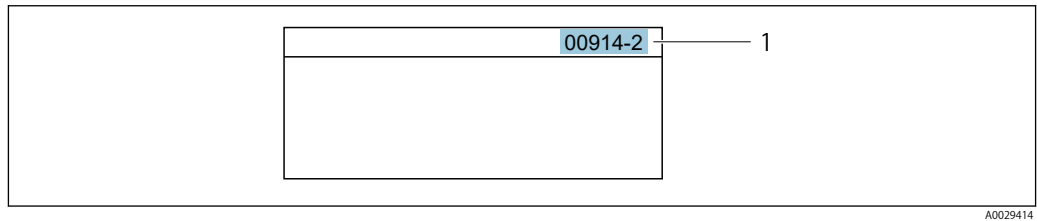

1 Direct access code

Note the following when entering the direct access code:

- The leading zeros in the direct access code do not have to be entered.
Example: Enter "914" instead of "00914"
- If no channel number is entered, channel 1 is accessed automatically.
Example: Enter 00914 → Assign process variable parameter
- If a different channel is accessed: Enter the direct access code with the corresponding channel number.
Example: Enter 00914-2 → Assign process variable parameter



For the direct access codes of the individual parameters, see the "Description of Device Parameters" document for the device

8.3.8 Calling up help text

Help text is available for some parameters and can be called up from the navigation view. The help text provides a brief explanation of the parameter function and thereby supports swift and safe commissioning.

Calling up and closing the help text

The user is in the navigation view and the selection bar is on a parameter.

1. Press for 2 s.
↳ The help text for the selected parameter opens.

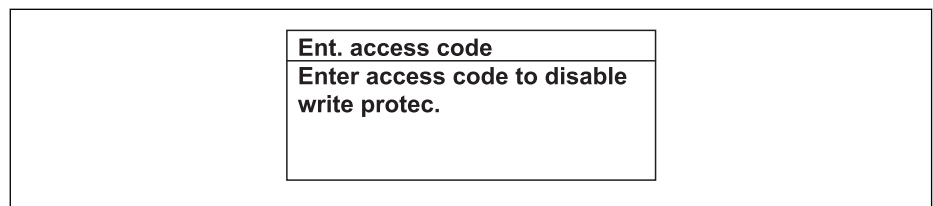

Example: Help text for parameter "Enter access code"

2. Press + simultaneously.
↳ The help text is closed.

8.3.9 Changing the parameters

i For a description of the editing view - consisting of the text editor and numeric editor - with symbols → See 8.3.3, for a description of the operating elements → See 8.3.4

Example: Changing the tag name in the "Tag description" parameter from 001-FT-101 to 001-FT-102

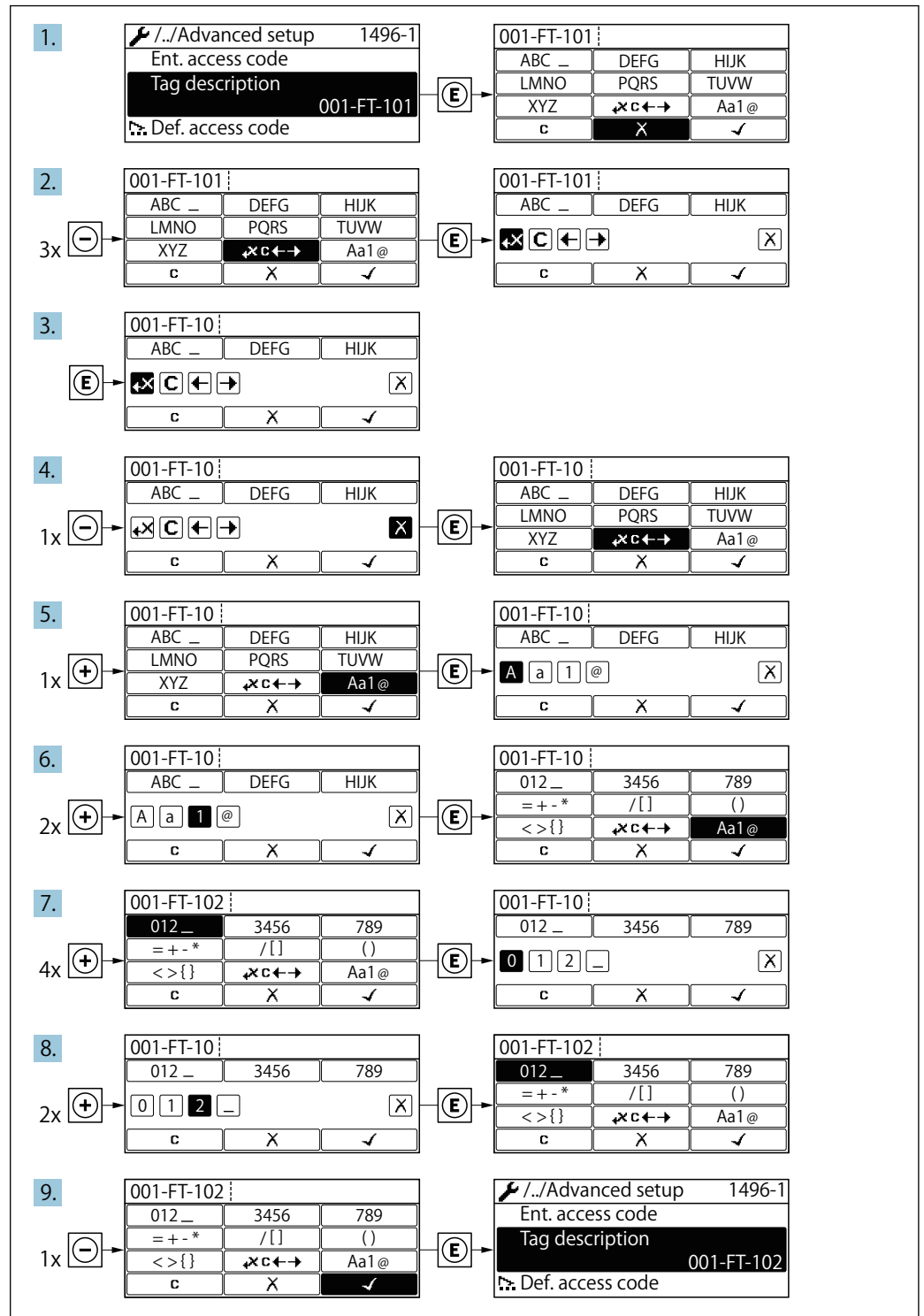

A0029563-EN

A message is displayed if the value entered is outside the permitted value range.

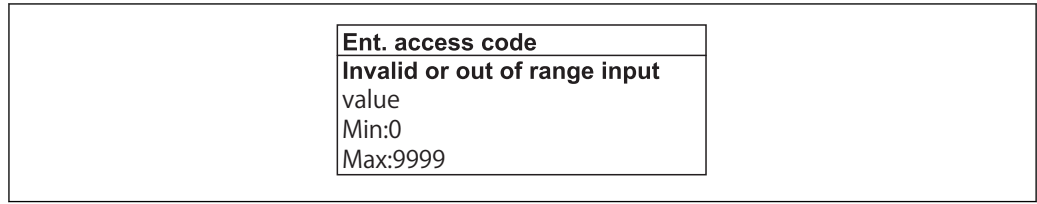

A0014049-EN

8.3.10 User roles and related access authorization

The two user roles "Operator" and "Maintenance" have different write access to the parameters if the customer defines a user-specific access code. This protects the device configuration via the local display from unauthorized access .

Defining access authorization for user roles

An access code is not yet defined when the device is delivered from the factory. Access authorization (read and write access) to the device is not restricted and corresponds to the "Maintenance" user role.

► Define the access code.

↳ The "Operator" user role is redefined in addition to the "Maintenance" user role. Access authorization differs for the two user roles.

Access authorization to parameters: "Maintenance" user role

Access code status	Read access	Write access
An access code has not yet been defined (factory setting).	✓	✓
After an access code has been defined.	✓	✓ ¹⁾

1) The user only has write access after entering the access code.

Access authorization to parameters: "Operator" user role

Access code status	Read access	Write access
After an access code has been defined.	✓	✓ ¹⁾

1) Despite the defined access code, certain parameters can always be modified and thus are excepted from the write protection, as they do not affect the measurement. Refer to the "Write protection via access code" section

i The user role with which the user is currently logged on is indicated by the Access status display parameter. Navigation path: Operation → Access status display

8.3.11 Disabling write protection via access code

If the -symbol appears on the local display in front of a parameter, the parameter is write-protected by a user-specific access code and its value cannot be changed at the moment using local operation → See 10.8.1.

Parameter write protection via local operation can be disabled by entering the user-specific access code in the Enter access code parameter via the respective access option.

1. After you press , the input prompt for the access code appears.

2. Enter the access code.



↳ The -symbol in front of the parameters disappears; all previously write-protected parameters are now re-enabled.

8.3.12 Enabling and disabling the keypad lock

The keypad lock makes it possible to block access to the entire operating menu via local operation. As a result, it is no longer possible to navigate through the operating menu or change the values of individual parameters. Users can only read the measured values on the operational display.



The keypad lock is switched on and off via the context menu.

To activate the keylock manually:

1. The device is in the measured value display.
Press the  and  keys for 3 seconds.
↳ A context menu appears.
2. In the context menu select the Keylock on option.
↳ The keypad lock is switched on.

 If the user attempts to access the operating menu while the keypad lock is active, the Keylock on message appears.

Switching off the keypad lock

- ▶ The keypad lock is switched on.
Press the  and  keys for 3 seconds.
↳ The keypad lock is switched off.

8.4 Access to the operating menu via the operating tool

The structure of the operating menu in the operating tools is the same as for operation via the local display.

8.4.1 Connecting the operating tool

Via HART protocol

This communication interface is available in device versions with a HART output.

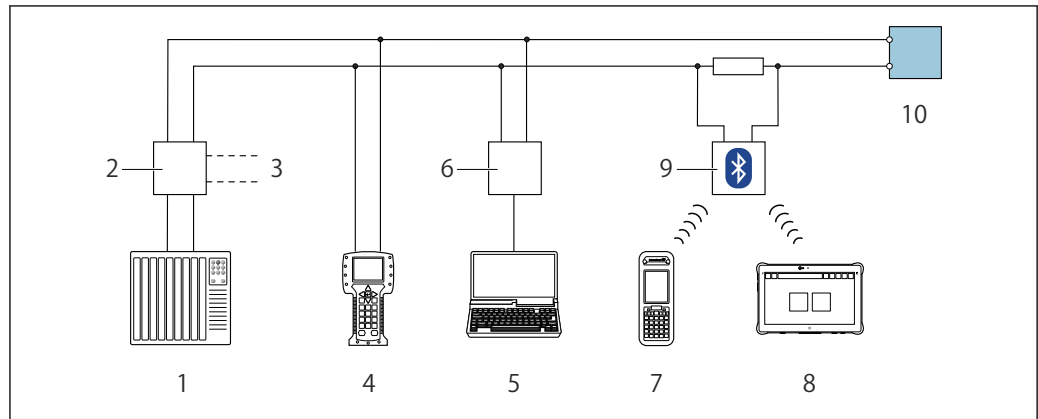

A0028746

Options for remote operation via HART protocol (passive)

- 1 Control system (e.g. PLC)
- 2 Transmitter power supply unit, e.g. RN221N (with communication resistor)
- 3 Connection for Commubox FXA195 and Field Communicator 475
- 4 Field Communicator 475
- 5 Computer with web browser (e.g. Internet Explorer) for accessing computers with operating tool (e.g. FieldCare, DeviceCare, AMS Device Manager, SIMATIC PDM) with COM DTM "CDI Communication TCP/IP"
- 6 Commubox FXA195 (USB)
- 7 Field Xpert SFX350 or SFX370
- 8 VIATOR Bluetooth modem with connecting cable
- 9 Transmitter

9 System integration

9.1 Overview of device description files

9.1.1 Current version data for the device

Firmware version	01.03.00	<ul style="list-style-type: none"> • On the title page of the Operating Instructions • On the transmitter nameplate • Firmware version parameter Diagnostics → Device information → Firmware version
Release date of firmware version	01.2018	---
Manufacturer ID	0x11	Manufacturer ID parameter Diagnostics → Device information → Manufacturer ID
Device type ID	0x38	Device type parameter Diagnostics → Device information → Device type
HART protocol revision	7	---
Device revision	4	<ul style="list-style-type: none"> • On the transmitter nameplate • Device revision parameter Diagnostics → Device information → Device revision



For an overview of the different firmware versions for the device

10 Commissioning

10.1 Function check

Before commissioning the measuring device:

- ▶ Make sure that the post-installation and post-connection checks have been performed.
- "Post-installation check" checklist → See 6.3
- "Post-connection check" checklist → See 7.4

10.2 Switching on the measuring device

- ▶ After a successful function check, switch on the measuring device.
 - ↳ After a successful startup, the local display switches automatically from the startup display to the operational display.

i If nothing appears on the local display or a diagnostic message is displayed, refer to the section on "Diagnostics and troubleshooting" → See 12.1

10.3 Setting the operating language

Factory setting: English or ordered local language

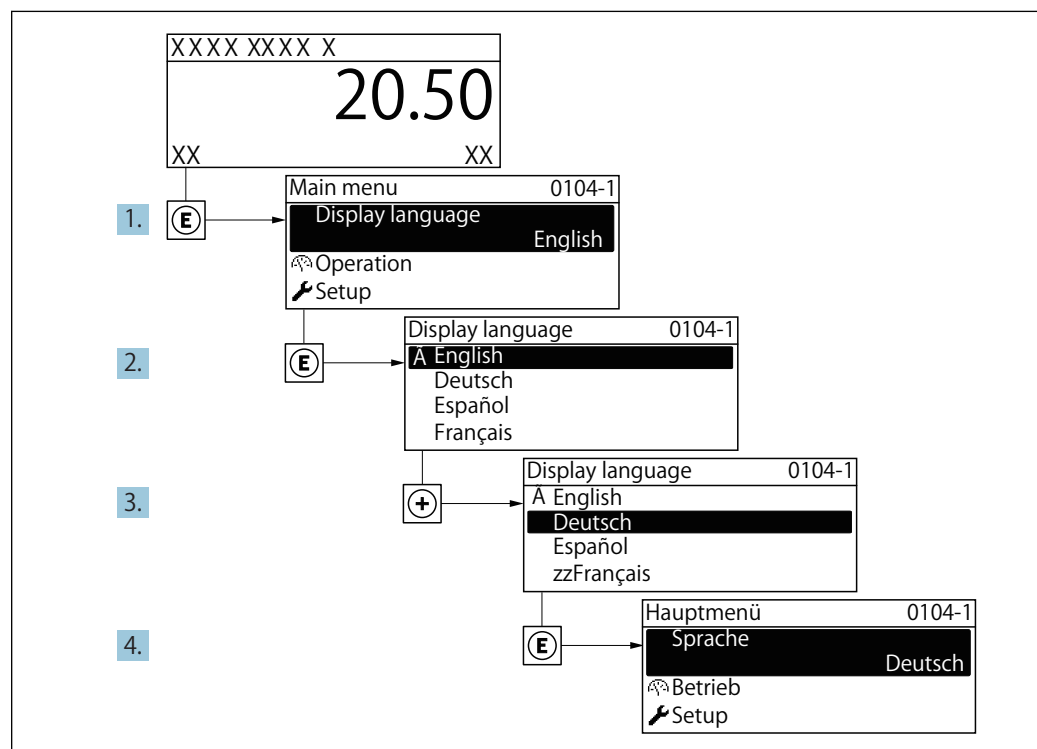

Taking the example of the local display

A0029420

10.4 Configuring the measuring device

- The Setup menu with its guided wizards contains all the parameters needed for standard operation.
- Navigation to the Setup menu

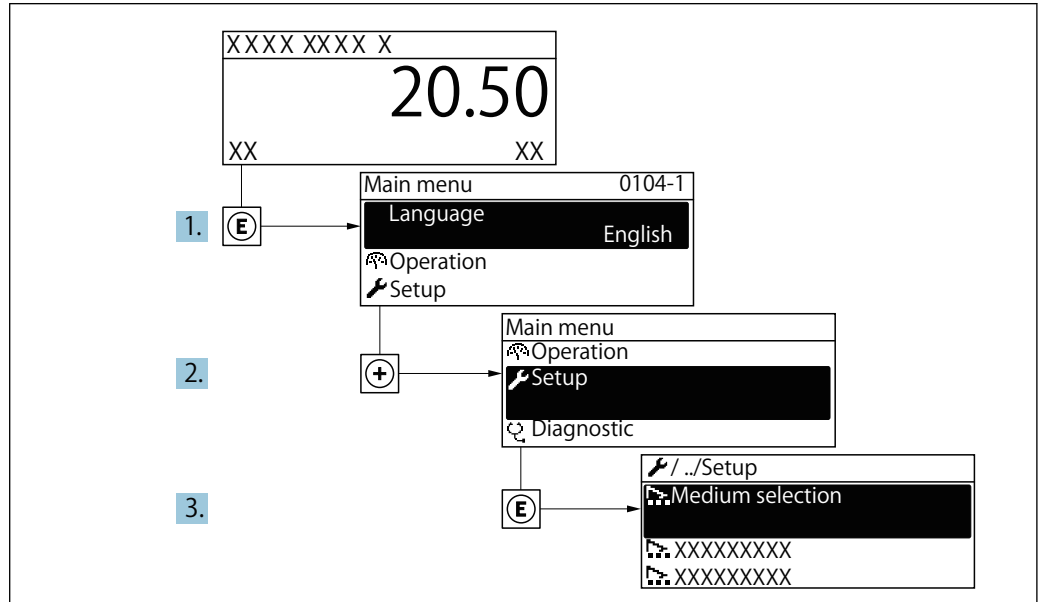

A0034189-EN

Taking the example of the local display

🔧 Setup	
Device tag	→ See 10.4.1
▶ System units	→ See 10.4.2
▶ Medium selection	→ See 10.4.3
▶ Current input	→ See 10.4.4
▶ Current output 1 to n	→ See 10.4.5
▶ Pulse/frequency/switch output	→ See 10.4.6
▶ Display	→ See 10.4.7
▶ Low flow cut off	→ See 10.4.8
▶ Advanced setup	→ See 10.5

10.4.1 Defining the tag name

To enable fast identification of the measuring point within the system, you can enter a unique designation using the Device tag parameter and thus change the factory setting.

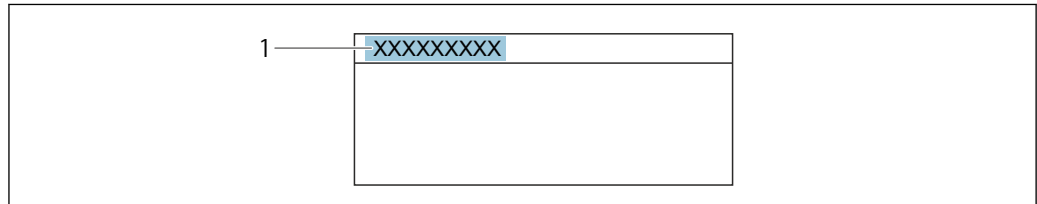

A0029422

Header of the operational display with tag name

1 Tag name

 Enter the tag name in the "FieldCare" operating tool

Navigation

"Setup" menu → Device tag

Parameter overview with brief description

Parameter	Description	User entry	Factory setting
Device tag	Enter the name for the measuring point.	Max. 32 characters, such as letters, numbers or special characters (e.g. @, %, /).	Prowirl

10.4.2 Setting the system units

In the System units submenu the units of all the measured values can be set.

 The number of submenus and parameters can vary depending on the device version. Certain submenus and parameters in these submenus are not described in the Operation Instructions. Instead a description is provided in the Special Documentation for the device (→ "Supplementary documentation" section).

Navigation

"Setup" menu → System units

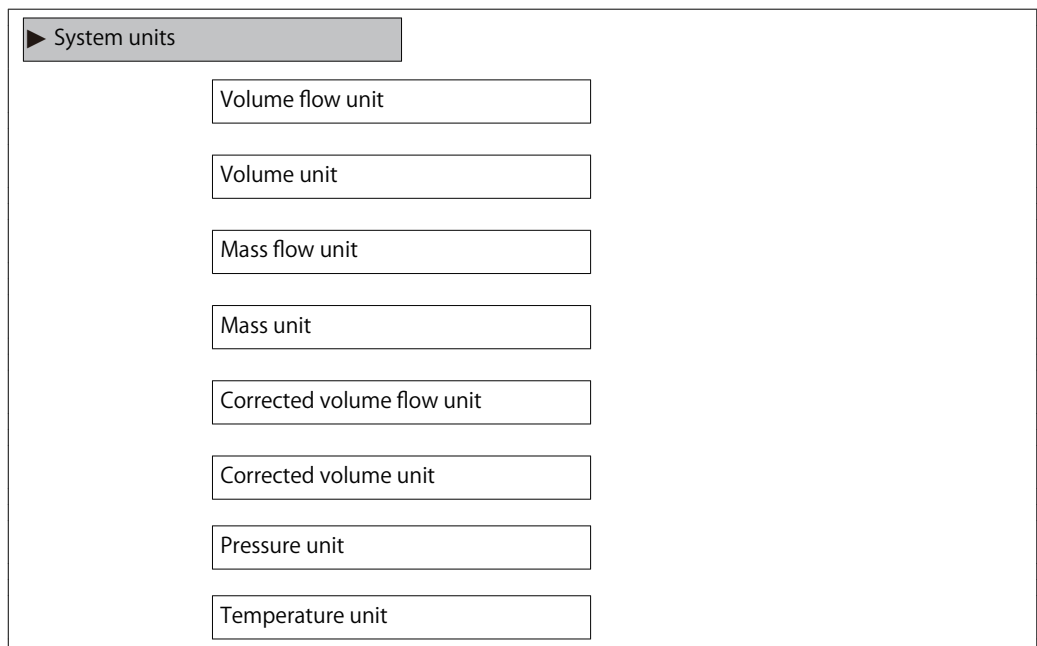

Energy flow unit
Energy unit
Calorific value unit
Calorific value unit
Velocity unit
Density unit
Specific volume unit
Dynamic viscosity unit
Length unit

Parameter overview with brief description

Parameter	Prerequisite	Description	Selection	Factory setting
Volume flow unit	–	Select volume flow unit. Result The selected unit applies for: • Output • Low flow cut off • Simulation process variable	Unit choose list	Country-specific: • m ³ /h • ft ³ /min
Volume unit	–	Select volume unit.	Unit choose list	Country-specific: • m ³ • ft ³
Mass flow unit	–	Select mass flow unit. Result The selected unit applies for: • Output • Low flow cut off • Simulation process variable	Unit choose list	Country-specific: • kg/h • lb/min
Mass unit	–	Select mass unit.	Unit choose list	Country-specific: • kg • lb
Corrected volume flow unit	–	Select corrected volume flow unit. Result The selected unit applies for: Corrected volume flow parameter (→ See 11.4.1)	Unit choose list	Country-specific: • Nm ³ /h • Sft ³ /h
Corrected volume unit	–	Select corrected volume unit.	Unit choose list	Country-specific: • Nm ³ • Sft ³

Parameter	Prerequisite	Description	Selection	Factory setting
Pressure unit	-	Select process pressure unit. Result The unit is taken from: <ul style="list-style-type: none"> • Calculated saturated steam pressure • Atmospheric pressure • Maximum value • Fixed process pressure • Pressure • Reference pressure 	Unit choose list	Country-specific: <ul style="list-style-type: none"> • bar • psi
Temperature unit	-	Select temperature unit. Result The selected unit applies for: <ul style="list-style-type: none"> • Temperature • Maximum value • Minimum value • Average value • Maximum value • Minimum value • Maximum value • Minimum value • 2nd temperature delta heat • Fixed temperature • Reference combustion temperature • Reference temperature • Saturation temperature 	Unit choose list	Country-specific: <ul style="list-style-type: none"> • ° C • ° F
Energy flow unit	-	Select energy flow unit. Result The selected unit applies for: <ul style="list-style-type: none"> • Heat flow difference parameter • Energy flow parameter 	Unit choose list	Country-specific: <ul style="list-style-type: none"> • kW • Btu/h
Energy unit	-	Select energy unit.	Unit choose list	Country-specific: <ul style="list-style-type: none"> • kWh • Btu
Calorific value unit	<ul style="list-style-type: none"> • The Gross calorific value volume option or the Net calorific value volume option is selected in the Calorific value type parameter. 	Select calorific value unit. Result The selected unit applies for: Reference gross calorific value	Unit choose list	Country-specific: <ul style="list-style-type: none"> • kJ/Nm³ • Btu/Sft³

Parameter	Prerequisite	Description	Selection	Factory setting
Calorific value unit (Mass)	<ul style="list-style-type: none"> The Gross calorific value mass option or the Net calorific value mass option is selected in the Calorific value type parameter. 	Select calorific value unit.	Unit choose list	Country-specific: <ul style="list-style-type: none"> kJ/kg Btu/lb
Velocity unit	–	Select velocity unit. Result The selected unit applies for: <ul style="list-style-type: none"> Flow velocity Maximum value 	Unit choose list	Country-specific: <ul style="list-style-type: none"> m/s ft/s
Density unit	–	Select density unit. Result The selected unit applies for: <ul style="list-style-type: none"> Output Simulation process variable 	Unit choose list	Country-specific: <ul style="list-style-type: none"> kg/m³ lb/ft³
Specific volume unit	–	Select the unit for the specific volume. Result The selected unit applies for: Specific volume	Unit choose list	Country-specific: <ul style="list-style-type: none"> m³/kg ft³/lb
Dynamic viscosity unit	–	Select dynamic viscosity unit. Result The selected unit applies for: <ul style="list-style-type: none"> Dynamic viscosity parameter (gases) Dynamic viscosity parameter (liquids) 	Unit choose list	Pa s
Length unit	–	Select length unit for nominal diameter. Result The selected unit applies for: <ul style="list-style-type: none"> Inlet run Mating pipe diameter 	Unit choose list	Country-specific: <ul style="list-style-type: none"> mm in

10.4.3 Selecting and setting the medium

The Medium selection wizard systematically guides the user through all the parameters that must be configured in order to select and set the medium.

Navigation

"Setup" menu → Medium selection



▶ Medium selection

 This product is intended for use with steam, water and air.

Parameter overview with brief description

Parameter	Prerequisite	Description	Selection / User entry	Factory setting
Select medium	–	Select medium type.	<ul style="list-style-type: none"> • Gas • Liquid • Steam 	Steam
Select gas type	The Gas option is selected in the Select medium parameter parameter.	Select measured gas type.	<ul style="list-style-type: none"> • Single gas • Gas mixture • Air • Natural gas • User-specific gas 	User-specific gas

Parameter	Prerequisite	Description	Selection / User entry	Factory setting
Gas type	The following conditions are met: <ul style="list-style-type: none"> In the Select medium parameter, theGas option is selected. In the Select gas type parameter, theSingle gas option is selected. 	Select measured gas type.	<ul style="list-style-type: none"> Hydrogen H2 Helium He Neon Ne Argon Ar Krypton Kr Xenon Xe Nitrogen N2 Oxygen O2 Chlorine Cl2 Ammonia NH3 Carbon monoxide CO Carbon dioxide CO2 Sulfur dioxide SO2 Hydrogen sulfide H2S Hydrogen chloride HCl Methane CH4 Ethane C2H6 Propane C3H8 Butane C4H10 Ethylene C2H4 Vinyl Chloride C2H3Cl 	Methane CH4
Relative humidity	The following conditions are met: <ul style="list-style-type: none"> In the Select medium parameter, theGas option is selected. In the Select gas type parameter, theAir option is selected. 	Enter humidity content of air in %.	0 to 100 %	0 %
Steam calculation mode	The Steam option is selected in the Select medium parameter parameter.	Select calculation mode of steam: based on saturated steam (T-compensated) or automatic detection (p-/T-compensated).	<ul style="list-style-type: none"> Saturated steam (T-compensated) Automatic (p-/T-compensated) 	Saturated steam (T-compensated)
Select liquid type	The following conditions are met: <ul style="list-style-type: none"> Order code for "Sensor version": <ul style="list-style-type: none"> Option "Mass (integrated temperature measurement)" or Option "Mass (integrated Pressure/temperature measurement)" The Liquid option is selected in the Select medium parameter parameter. 	Select measured liquid type.	<ul style="list-style-type: none"> Water LPG (Liquefied Petroleum Gas) User-specific liquid 	Water

Parameter	Prerequisite	Description	Selection / User entry	Factory setting
Select liquid type	The following conditions are met: <ul style="list-style-type: none"> • Order code for "Sensor version", • Option "Mass (integrated temperature measurement)" or • Option "Mass (integrated pressure/temperature measurement)" • The Liquid option is selected in the Select medium parameter. 	Select measured liquid type.	<ul style="list-style-type: none"> • Water • LPG (Liquefied Petroleum Gas) • User-specific liquid 	Water
Fixed process pressure	The following conditions are met: <ul style="list-style-type: none"> • Order code for "Sensor version", • Option "Mass flow (integrated temperature measurement)" or • Option "Mass flow (integrated pressure/temperature measurement)" • In the External value parameter (→ See 10.5.2) the Pressure option is not selected. 	Enter fixed value for process pressure. Dependency The unit is taken from the Pressure unit parameter.  For detailed information on the calculation of the measured variables with steam: → See 10.9.4  For detailed information on setting the parameter in steam applications, see the Special Documentation for the Wet Steam Detection and Wet Steam Measurement application package	0 to 250 bar abs.	0 bar abs.
Enthalpy calculation	In the Select medium parameter, the Gas option is selected and in the Select gas type parameter, the Natural gas option is selected.	Select the norm the enthalpy calculation is based on.	<ul style="list-style-type: none"> • AGA5 • ISO 6976 	AGA5

Parameter	Prerequisite	Description	Selection / User entry	Factory setting
Density calculation	The following conditions are met: <ul style="list-style-type: none"> In the Select medium parameter, theGas option is selected. In the Select gas type parameter, theNatural gas option is selected. 	Select the norm the density calculation is based on.	<ul style="list-style-type: none"> AGA Nx19 ISO 12213- 2 ISO 12213- 3 	AGA Nx19
Enthalpy type	The following conditions are met: <ul style="list-style-type: none"> In the Select gas type parameter, theUser-specific gas option is selected. Or <ul style="list-style-type: none"> In the Select liquid type parameter, theUser-specific liquid option is selected. 	Define which kind of enthalpy is used.	<ul style="list-style-type: none"> Heat Calorific value 	Heat

10.4.4 Configuring the current input

The "Current input" wizard guides the user systematically through all the parameters that have to be set for configuring the current input.

Navigation

"Setup" menu → Current input

10.4.5 Configuring the current output

The Current output wizard guides you systematically through all the parameters that have to be set for configuring the current output.

Navigation

"Setup" menu → Current output 1

▶ Current output 1

Assign current output 1

Current span

4 mA value

20 mA value

Fixed current

Damping output 1

Failure mode

Failure current

Parameter overview with brief description

Parameter	Prerequisite	Description	Selection / User entry	Factory setting
Assign current output	–	Select process variable for current output.	<ul style="list-style-type: none"> • Off • Volume flow • Corrected volume flow • Mass flow • Flow velocity • Temperature • Pressure • Calculated saturated steam pressure* • Steam quality* • Total mass flow* • Energy flow* • Heat flow difference* 	Volume flow
Current span	–	Select current range for process value output and upper/lower level for alarm signal.	<ul style="list-style-type: none"> • 4...20 mA NAMUR • 4...20 mA US • 4...20 mA • Fixed current 	Country-specific: <ul style="list-style-type: none"> • 4...20 mA NAMUR • 4...20 mA US
4 mA value	In the Current span parameter one of the following options is selected: <ul style="list-style-type: none"> • 4...20 mA NAMUR • 4...20 mA US • 4...20 mA 	Enter 4 mA value.	Signed floating-point number	Country-specific: <ul style="list-style-type: none"> • 0 m³/h • 0 ft³/min

Parameter	Prerequisite	Description	Selection / User entry	Factory setting
20 mA value	One of the following options is selected in the Current span parameter : <ul style="list-style-type: none"> • 4...20 mA NAMUR • 4...20 mA US • 4...20 mA 	Enter 20 mA value.	Signed floating-point number	Depends on country and nominal diameter
Fixed current	The Fixed current option is selected in the Current span parameter .	Defines the fixed output current.	3.59 to 22.5 mA	4 mA
Damping output 1	–	Set the reaction time of the output signal of the current output to fluctuations in the measured value.	0 to 999.9 s	1 s
Failure mode	A process variable is selected in the Assign current output parameter and one of the following options is selected in the Current span parameter : <ul style="list-style-type: none"> • 4...20 mA NAMUR • 4...20 mA US • 4...20 mA 	Define output behavior in alarm condition.	<ul style="list-style-type: none"> • Min. • Max. • Last valid value • Actual value • Defined value 	Max.
Failure current	The Defined value option is selected in the Failure mode parameter.	Enter current output value in alarm condition.	3.59 to 22.5 mA	22.5 mA

* Visibility depends on order options or device settings

10.4.6 Configuring the pulse/frequency/switch output

The Pulse/frequency/switch output wizard guides you systematically through all the parameters that can be set for configuring the selected output type.

Navigation

"Setup" menu → Pulse/frequency/switch output

Pulse/frequency/switch output

Operating mode

Parameter overview with brief description

Parameter	Description	Selection	Factory setting
Operating mode	Define the output as a pulse, frequency or switch output.	<ul style="list-style-type: none"> • Pulse • Frequency • Switch 	Pulse

Configuring the pulse output

Navigation

"Setup" menu → Pulse/frequency/switch output

Pulse/frequency/switch output

Assign pulse output 1

Value per pulse

Pulse width

Failure mode

Invert output signal

Parameter overview with brief description

Parameter	Prerequisite	Description	Selection / User entry	Factory setting
Assign pulse output 1	The Pulse option is selected in the Operating mode parameter parameter.	Select process variable for pulse output.	<ul style="list-style-type: none"> • Off • Volume flow • Corrected volume flow • Mass flow • Total mass flow * • Energy flow * • Heat flow difference* 	Volume flow
Value per pulse	The Pulse option is selected in the Operating mode parameter and a process variable is selected in the Assign pulse output parameter.	Enter measured value at which a pulse is output.	Positive floating point number	Depends on country and nominal diameter
Pulse width	The Pulse option is selected in the Operating mode parameter and a process variable is selected in the Assign pulse output parameter.	Define time width of the output pulse.	5 to 2000 ms	100 ms
Failure mode	The Pulse option is selected in the Operating mode parameter and a process variable is selected in the Assign pulse output parameter .	Define output behavior in alarm condition.	<ul style="list-style-type: none"> • Actual value • No pulses 	No pulses
Invert output signal	–	Invert the output signal.	<ul style="list-style-type: none"> • No • Yes 	No

* Visibility depends on order options or device settings

Configuring the frequency output

Navigation

"Setup" menu → Pulse/frequency/switch output

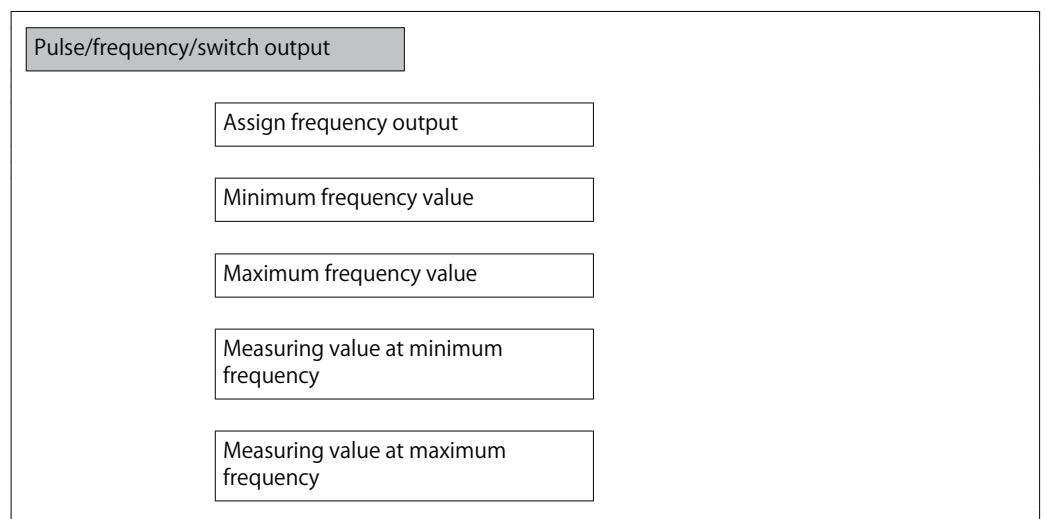

Failure mode
Failure frequency
Invert output signal

Parameter overview with brief description

Parameter	Prerequisite	Description	Selection / User entry	Factory setting
Assign frequency output	The Frequency option is selected in the Operating mode parameter (→ See 10.4.6).	Select process variable for frequency output.	<ul style="list-style-type: none"> • Off • Volume flow • Corrected volume flow • Mass flow • Flow velocity • Temperature • Pressure • Calculated saturated steam pressure* • Steam quality* • Total mass flow* • Energy flow* • Heat flow difference* 	Off
Minimum frequency value	The Frequency option is selected in the Operating mode parameter and a process variable is selected in the Assign frequency output parameter.	Enter minimum frequency.	0 to 1 000 Hz	0 Hz
Maximum frequency value	The Frequency option is selected in the Operating mode parameter and a process variable is selected in the Assign frequency output parameter.	Enter maximum frequency.	0 to 1 000 Hz	1 000 Hz
Measuring value at minimum frequency	The Frequency option is selected in the Operating mode parameter and a process variable is selected in the Assign frequency output parameter.	Enter measured value for minimum frequency.	Signed floating-point number	Depends on country and nominal diameter
Measuring value at maximum frequency	The Frequency option is selected in the Operating mode parameter and a process variable is selected in the Assign frequency output parameter.	Enter measured value for maximum frequency.	Signed floating-point number	Depends on country and nominal diameter
Failure mode	The Frequency option is selected in the Operating mode parameter and a process variable is selected in the Assign frequency output parameter.	Define output behavior in alarm condition.	<ul style="list-style-type: none"> • Actual value • Defined value • 0 Hz 	0 Hz

Parameter	Prerequisite	Description	Selection / User entry	Factory setting
Failure frequency	The Frequency option is selected in the Operating mode parameter and a process variable is selected in the Assign frequency output parameter.	Enter frequency output value in alarm condition.	0.0 to 1 250.0 Hz	0.0 Hz
Invert output signal	–	Invert the output signal.	<ul style="list-style-type: none"> • No • Yes 	No

* Visibility depends on order options or device settings

Configuring the switch output

Navigation

"Setup" menu → Pulse/frequency/switch output

Pulse/frequency/switch output

Parameter overview with brief description

Parameter	Prerequisite	Description	Selection / User entry	Factory setting
Switch output function	The Switch option is selected in the Operating mode parameter.	Select function for switch output.	<ul style="list-style-type: none"> • Off • On • Diagnostic behavior • Limit • Status 	Off
Assign diagnostic behavior	<ul style="list-style-type: none"> • In the Operating mode parameter, the Switch option is selected. • In the Switch output function parameter, the Diagnostic behavior option is selected. 	Select diagnostic behavior for switch output.	<ul style="list-style-type: none"> • Alarm • Alarm or warning • Warning 	Alarm
Assign limit	<ul style="list-style-type: none"> • The Switch option is selected in the Operating mode parameter. • The Limit option is selected in the Switch output function parameter. 	Select process variable for limit function.	<ul style="list-style-type: none"> • Volume flow • Corrected volume flow • Mass flow • Flow velocity • Temperature • Pressure • Calculated saturated steam pressure* • Steam quality* • Total mass flow* • Energy flow* • Heat flow difference* • Reynolds number* • Totalizer 1 • Totalizer 2 • Totalizer 3 	Volume flow
Assign status	<ul style="list-style-type: none"> • The Switch option is selected in the Operating mode parameter. • The Status option is selected in the Switch output function parameter. 	Select device status for switch output.	Low flow cut off	Low flow cut off
Switch-on value	<ul style="list-style-type: none"> • The Switch option is selected in the Operating mode parameter. • The Limit option is selected in the Switch output function parameter. 	Enter measured value for the switch-on point.	Signed floating-point number	Country-specific: <ul style="list-style-type: none"> • 0 m³/h • 0 ft³/h
Switch-off value	<ul style="list-style-type: none"> • The Switch option is selected in the Operating mode parameter. • The Limit option is selected in the Switch output function parameter. 	Enter measured value for the switch-off point.	Signed floating-point number	Country-specific: <ul style="list-style-type: none"> • 0 m³/h • 0 ft³/h
Switch-on delay	<ul style="list-style-type: none"> • The Switch option is selected in the Operating mode parameter. • The Limit option is selected in the Switch output function parameter. 	Define delay for the switch-on of status output.	0.0 to 100.0 s	0.0 s

Parameter	Prerequisite	Description	Selection / User entry	Factory setting
Switch-off delay	<ul style="list-style-type: none"> The Switch option is selected in the Operating mode parameter. The Limit option is selected in the Switch output function parameter. 	Define delay for the switch-off of status output.	0.0 to 100.0 s	0.0 s
Failure mode	–	Define output behavior in alarm condition.	<ul style="list-style-type: none"> Actual status Open Closed 	Open
Invert output signal **	–	Invert the output signal.	<ul style="list-style-type: none"> No Yes 	No

* Visibility depends on order options or device settings

** Switch output isn't inverted when "Open" or "Close" is selected for the Failure mode option

10.4.7 Configuring the local display

The Display wizard guides you systematically through all the parameters that can be configured for configuring the local display.

Navigation

"Setup" menu → Display

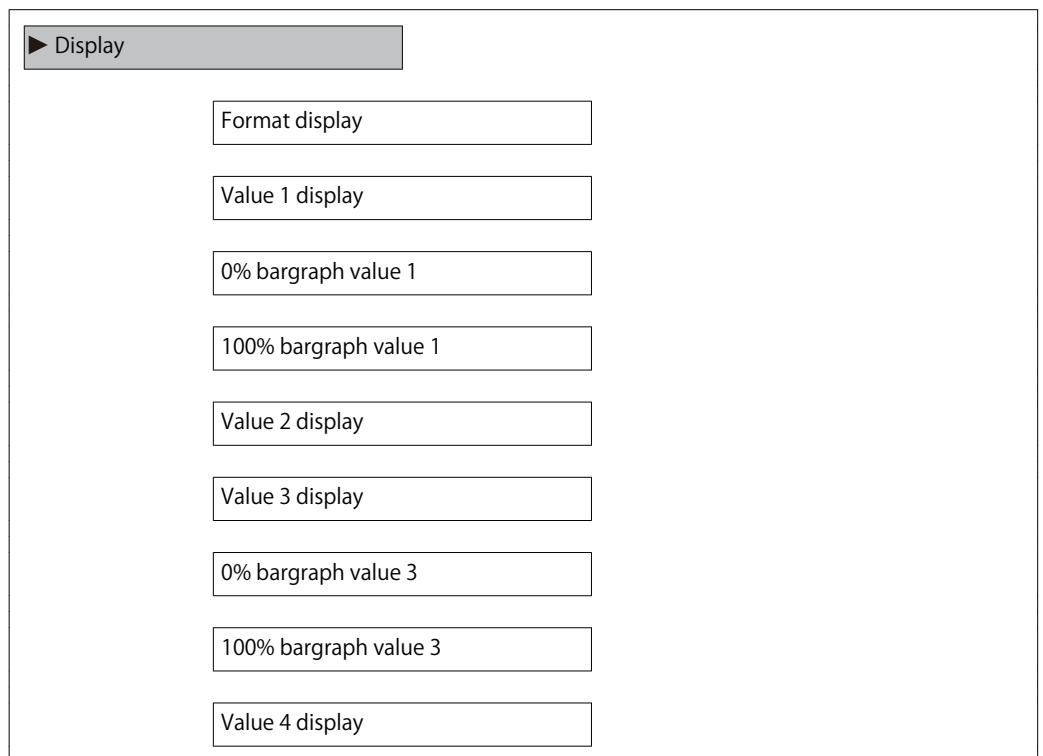

Parameter overview with brief description

Parameter	Prerequisite	Description	Selection / User entry	Factory setting
Format display	A local display is provided.	Select how measured values are shown on the display.	<ul style="list-style-type: none"> • 1 value, max. size • 1 bargraph + 1 value • 2 values • 1 value large + 2 values • 4 values 	1 value, max. size
Value 1 display	A local display is provided.	Select the measured value that is shown on the local display.	<ul style="list-style-type: none"> • Volume flow • Corrected volume flow • Mass flow • Flow velocity • Temperature • Calculated saturated steam pressure* • Steam quality* • Total mass flow* • Condensate mass flow* • Energy flow* • Heat flow difference* • Reynolds number* • Density* • Pressure* • Specific volume* • Degrees of superheat* • Totalizer 1 • Totalizer 2 • Totalizer 3 • Current output 1 • Current output 2* 	Volume flow
0% bargraph value 1	A local display is provided.	Enter 0% value for bar graph display.	Signed floating-point number	Country-specific: • 0 m ³ /h • 0 ft ³ /h
100% bargraph value 1	A local display is provided.	Enter 100% value for bar graph display.	Signed floating-point number	Depends on country and nominal diameter
Value 2 display	A local display is provided.	Select the measured value that is shown on the local display.	For the picklist, see the Value 1 display parameter	None
Value 3 display	A local display is provided.	Select the measured value that is shown on the local display.	For the picklist, see the Value 1 display parameter (→ See 10.5.5)	None
0% bargraph value 3	A selection was made in the Value 3 display parameter.	Enter 0% value for bar graph display.	Signed floating-point number	Country-specific: • 0 m ³ /h • 0 ft ³ /h
100% bargraph value 3	A selection was made in the Value 3 display parameter.	Enter 100% value for bar graph display.	Signed floating-point number	0
Value 4 display	A local display is provided.	Select the measured value that is shown on the local display.	For the picklist, see the Value 1 display parameter (→ See 10.5.5)	None

* Visibility depends on order options or device settings

10.4.8 Configuring the low flow cut off

The Low flow cut off wizard systematically guides the user through all the parameters that must be set to configure low flow cut off.

The measuring signal must have a certain minimum signal amplitude so that the signals can be evaluated without any errors. Using the nominal diameter, the corresponding flow can also be derived from this amplitude. The minimum signal amplitude depends on the setting for the sensitivity of the DSC sensor (s), the steam quality (x) and the force of the vibrations present (a). The value mf corresponds to the lowest measurable flow velocity without vibration (no wet steam) at a density of 1 kg/m³ (0.0624 lbm/ft³). The value mf can be set in the range from 6 to 20 m/s (1.8 to 6 ft/s) (factory setting 12 m/s (3.7 ft/s)) with the Sensitivity parameter (value range 1 to 9, factory setting 5).

The lowest flow velocity that can be measured on account of the signal amplitude v_{AmpMin} is derived from the Sensitivity parameter and the steam quality (x) or from the force of vibrations present (a).

Navigation

"Setup" menu → Low flow cut off

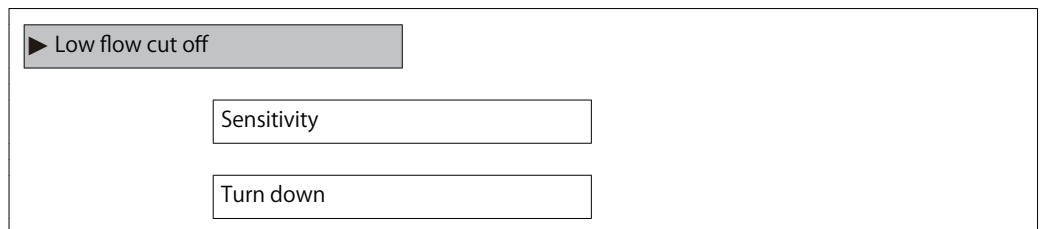

Parameter overview with brief description

Parameter	Description	User entry	Factory setting
Sensitivity	Adjust sensitivity of the device in the lower flow range. Lower sensitivity leads to more robustness against external interference. The parameter determines the level of sensitivity at the lower end of the measuring range (start of measuring range). Low values can improve the robustness of the device with regard to external influences. The start of measuring range is then set to a higher value. The smallest specified measuring range is when sensitivity is at a maximum.	1 to 9	5
Turn down	Adjust the turn down. Lower turn down increases the minimum measureable flow frequency. The measuring range can be limited with this parameter, if necessary. The upper end of the measuring range is not affected. The start of the low end of the measuring range can be changed to a higher flow value, making it possible to cut off low flows, for example.	50 to 100 %	100 %

10.5 Advanced settings

The Advanced setup submenu together with its submenus contains parameters for specific settings.

Navigation to the "Advanced setup" submenu

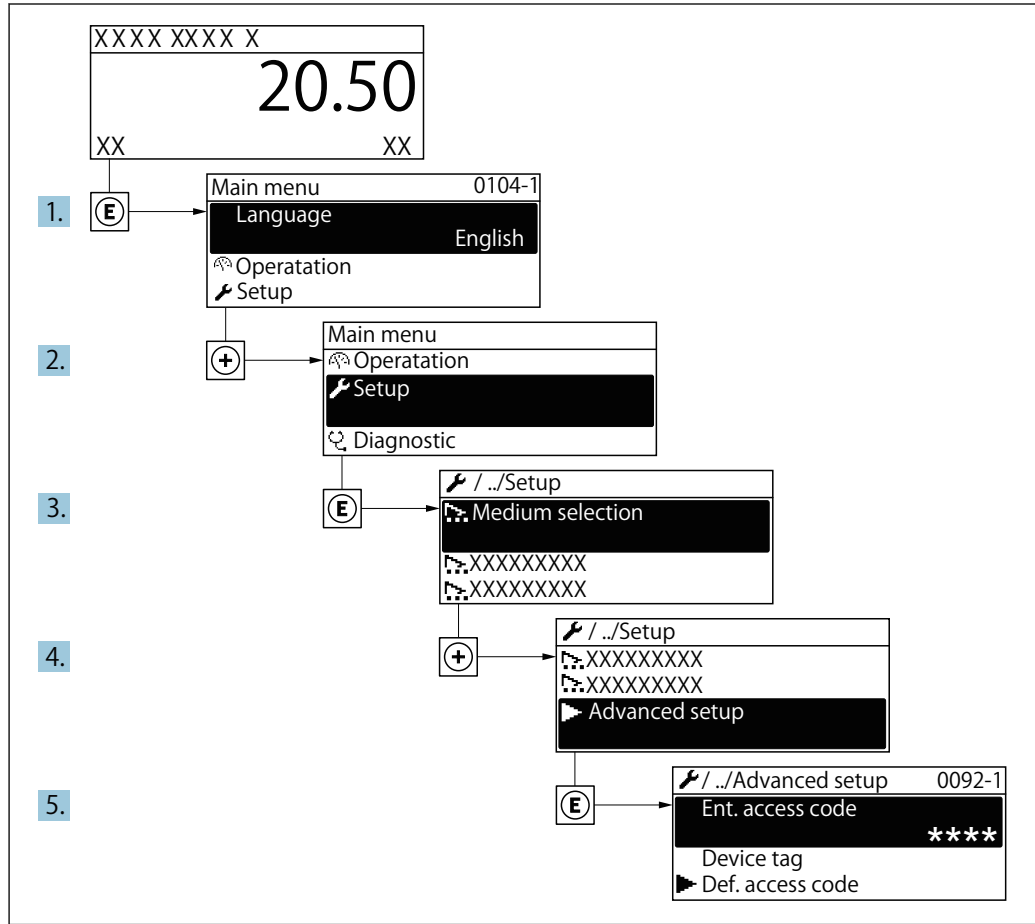

A0034208-EN

i The number of submenus can vary depending on the device version. Some submenus are not dealt with in the Operating Instructions. These submenus and the parameters they contain are explained in the Special Documentation for the device.

Navigation

"Setup" menu → Advanced setup

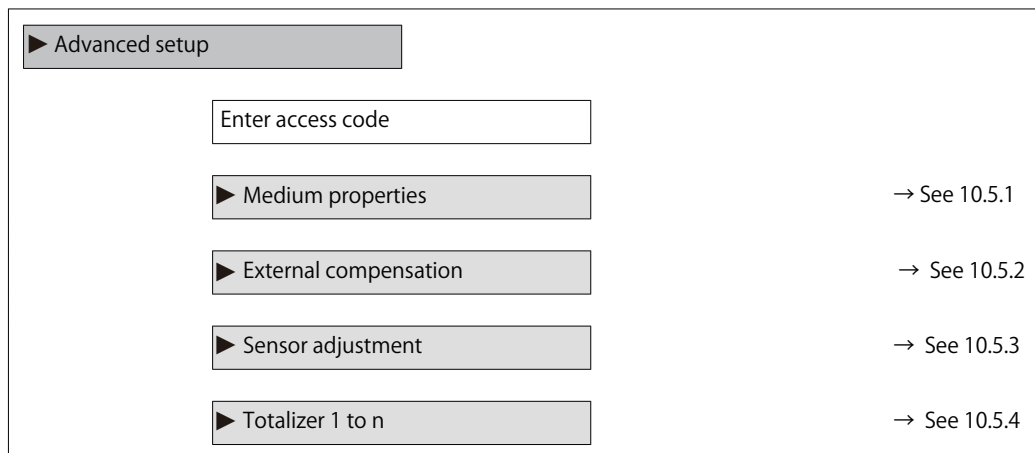

▶ SIL confirmation	
▶ Deactivate SIL	
▶ Display	→ See 10.5.5
▶ Heartbeat setup	
▶ Configuration backup display	→ See 10.5.6
▶ Administration	→ See 10.5.7

10.5.1 Setting the medium properties

In the Medium properties submenu the reference values for the measuring application can be set.

Navigation

"Setup" menu → Advanced setup → Medium properties

▶ Medium properties
Enthalpy type
Calorific value type
Reference combustion temperature
Reference density
Reference gross calorific value
Reference pressure
Reference temperature
Reference Z-factor
Linear expansion coefficient
Relative density
Specific heat capacity
Calorific value
Z-factor
Dynamic viscosity

<input type="text" value="Dynamic viscosity"/> <input checked="" type="radio"/> Gas composition
--

Parameter overview with brief description

Parameter	Prerequisite	Description	Selection / User entry	Factory setting
Enthalpy type	The following conditions are met: <ul style="list-style-type: none"> In the Select gas type parameter, the User-specific gas option is selected. Or In the Select liquid type parameter, the User-specific liquid option is selected. 	Define which kind of enthalpy is used.	<ul style="list-style-type: none"> Heat Calorific value 	Heat
Calorific value type	The Calorific value type parameter is visible.	Select calculation based on gross calorific value or net calorific value.	<ul style="list-style-type: none"> Gross calorific value volume Net calorific value volume Gross calorific value mass Net calorific value mass 	Gross calorific value mass
Reference combustion temperature	The Reference combustion temperature parameter is visible.	Enter reference combustion temperature to calculate the natural gas energy value. Dependency The unit is taken from the Temperature unit parameter	-200 to 450 ° C	20 ° C
Reference density	The following conditions are met: <ul style="list-style-type: none"> In the Select gas type parameter, the User-specific gas option is selected. Or In the Select liquid type parameter, the Water option or User-specific liquid option is selected. 	Enter fixed value for reference density. Dependency The unit is taken from the Density unit parameter	0.01 to 15 000 kg/m ³	1 000 kg/m ³
Reference gross calorific value	The following conditions are met: <ul style="list-style-type: none"> In the Select medium parameter, the Gas option is selected. In the Select gas type parameter, the Natural gas option is selected. In the Density calculation parameter, the ISO 12213-3 option is selected. 	Enter reference gross calorific value of the natural gas. Dependency The unit is taken from the Calorific value unit parameter	Positive floating-point number	50 000 kJ/Nm ³

Parameter	Prerequisite	Description	Selection / User entry	Factory setting
Reference pressure	The following conditions are met: <ul style="list-style-type: none"> • Order code for "Sensor version", • Option "Mass (integrated temperature measurement)" or • Option "Mass (integrated pressure/temperature measurement)" • The Gas option is selected in the Select medium parameter parameter. 	Enter reference pressure for the calculation of the reference density. Dependency The unit is taken from the Pressure unit parameter.	0 to 250 bar	1.01325 bar
Reference temperature	The following conditions are met: <ul style="list-style-type: none"> • The Gas option is selected in the Select medium parameter. Or • The Liquid option is selected in the Select medium parameter. 	Enter reference temperature for calculating the reference density. Dependency The unit is taken from the Temperature unit parameter	-200 to 450 ° C	20 ° C
Reference Z-factor	In the Select gas type parameter, the User-specific gas option is selected.	Enter real gas constant Z for gas under reference conditions.	0.1 to 2	1
Linear expansion coefficient	The following conditions are met: <ul style="list-style-type: none"> • The Liquid option is selected in the Select medium parameter. • The User-specific liquid option is selected in the Select liquid type parameter. 	Enter linear, medium-specific expansion coefficient for calculating the reference density.	$1.0 \cdot 10^{-6}$ to $2.0 \cdot 10^{-3}$	$2.06 \cdot 10^{-4}$
Relative density	The following conditions are met: <ul style="list-style-type: none"> • In the Select medium parameter, the Gas option is selected. • In the Select gas type parameter, the Natural gas option is selected. • In the Density calculation parameter, the ISO 12213-3 option is selected. 	Enter a relative density of the natural gas.	0.55 to 0.9	0.664
Specific heat capacity	The following conditions are met: <ul style="list-style-type: none"> • Selected medium: <ul style="list-style-type: none"> • In the Select gas type parameter, the User-specific gas option is selected. Or • In the Select liquid type parameter, the User-specific liquid option is selected. • In the Enthalpy type parameter, the Heat option is selected. 	Enter the specific heat capacity of the medium. Dependency The unit is taken from the Specific heat capacity unit parameter	0 to 50 kJ/(kgK)	4.187 kJ/(kgK)

Parameter	Prerequisite	Description	Selection / User entry	Factory setting
Calorific value	The following conditions are met: <ul style="list-style-type: none"> Selected medium: <ul style="list-style-type: none"> In the Select gas type parameter, the User-specific gas option is selected. Or In the Select liquid type parameter, the User-specific liquid option is selected. In the Enthalpy type parameter, the Calorific value option is selected. In the Calorific value type parameter, the Gross calorific value volume option or Gross calorific value mass option is selected. 	Enter gross calorific value to calculate the energy flow.	Positive floating-point number	50 000 kJ/kg
Z-factor	In the Select gas type parameter, the User-specific gas option is selected.	Enter real gas constant Z for gas under operation conditions.	0.1 to 2.0	1
Dynamic viscosity (Gases)	The following conditions are met: <ul style="list-style-type: none"> Order code for "Sensor version", <ul style="list-style-type: none"> Option "Volume" or Option "Volume high temperature" The Gas option or the Steam option is selected in the Select medium parameter. or The User-specific gas option is selected in the Select gas type parameter. 	Enter fixed value for dynamic viscosity for a gas/steam. Dependency The unit is taken from the Dynamic viscosity unit parameter.	Positive floating-point number	0.015 cP
Dynamic viscosity (Liquids)	The following conditions are met: <ul style="list-style-type: none"> Order code for "Sensor version", <ul style="list-style-type: none"> Option "Volume" or Option "Volume high temperature" The Liquid option is selected in the Select medium parameter. or The User-specific liquid option is selected in the Select liquid type parameter. 	Enter fixed value for dynamic viscosity for a liquid. Dependency The unit is taken from the Dynamic viscosity unit parameter.	Positive floating-point number	1 cP

Configuring the gas composition

In the Gas composition submenu the gas composition for the measuring application can be set.

Navigation

"Setup" menu → Advanced setup → Medium properties → Gas composition

 This product is intended for use with steam, water and air.

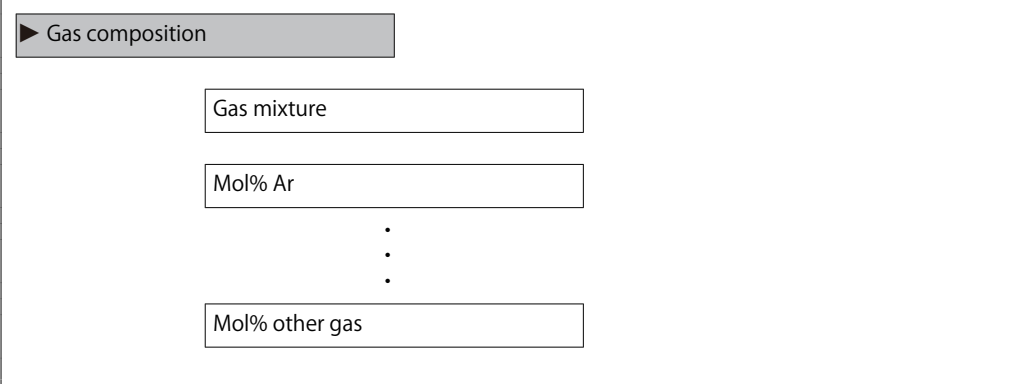

The screenshot shows a software interface for setting gas composition. At the top, there is a grey button labeled "Gas composition" with a right-pointing triangle. Below this button, there are four input fields arranged vertically. The first field is labeled "Gas mixture". The second field is labeled "Mol% Ar". Below the second field, there are three vertical dots indicating a list of other gas components. The final field is labeled "Mol% other gas".

10.5.2 Performing external compensation

The External compensation submenu contains parameters which can be used to enter external or fixed values. These values are used for internal calculations.

Navigation



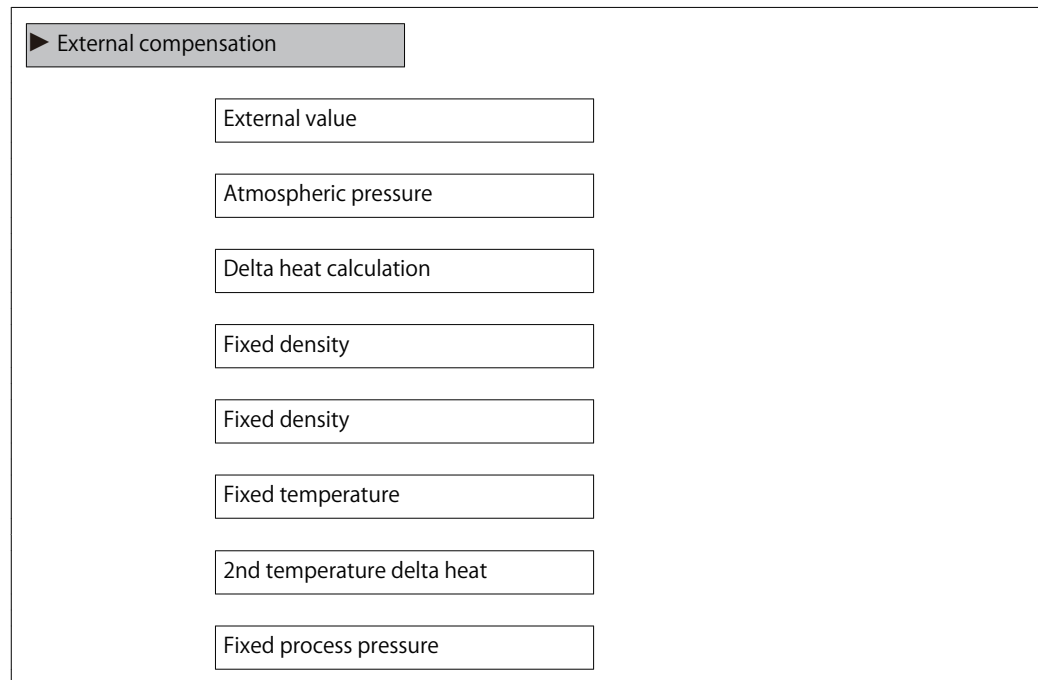

"Setup" menu → Advanced setup → External compensation



The image shows a screenshot of the 'External compensation' submenu. At the top left, there is a grey header box with a right-pointing triangle and the text 'External compensation'. Below this header, there are eight rectangular input fields, each containing a parameter name:

- External value
- Atmospheric pressure
- Delta heat calculation
- Fixed density
- Fixed density
- Fixed temperature
- 2nd temperature delta heat
- Fixed process pressure

Parameter overview with brief description

Parameter	Prerequisite	Description	Selection / User entry	Factory setting
External value	-	<p>Assign variable from external device to process variable.</p> <p> For detailed information on the calculation of the measured variables with steam: → See 10.9.4</p> <p> For detailed information on setting the parameter in steam applications, see the Special Documentation for the Wet Steam Detection and Wet Steam Measurement application package</p>	<ul style="list-style-type: none"> • Off • Pressure • Gauge pressure • Density • Temperature • 2nd temperature delta heat 	Off
Atmospheric pressure	In the External value parameter, the Gauge pressure option is selected.	<p>Enter atmospheric pressure value to be used for pressure correction.</p> <p>Dependency The unit is taken from the Pressure unit parameter</p>	0 to 250 bar	1.01325 bar
Delta heat calculation	The Delta heat calculation parameter is visible.	Calculates the transferred heat of a heat exchanger (= delta heat).	<ul style="list-style-type: none"> • Off • Device on cold side • Device on warm side 	Device on warm side
Fixed temperature	-	<p>Enter a fixed value for process temperature.</p> <p>Dependency The unit is taken from the Temperature unit parameter</p>	-200 to 450 ° C	20 ° C
2nd temperature delta heat	The 2nd temperature delta heat parameter is visible.	<p>Enter 2nd temperature value to calculate the delta heat.</p> <p>Dependency The unit is taken from the Temperature unit parameter</p>	-200 to 450 ° C	20 ° C
Fixed process pressure	-	<p>Enter fixed value for process pressure.</p> <p>Dependency The unit is taken from the Pressure unit parameter.</p> <p> For detailed information on the calculation of the measured variables with steam: → See 10.9.4</p> <p> For detailed information on setting the parameter in steam applications, see the Special Documentation for the Wet Steam Detection and Wet Steam Measurement application package</p>	0 to 250 bar abs.	0 bar abs.

10.5.3 Carrying out a sensor adjustment

The Sensor adjustment submenu contains parameters that pertain to the functionality of the sensor.

Navigation

"Setup" menu → Advanced setup → Sensor adjustment

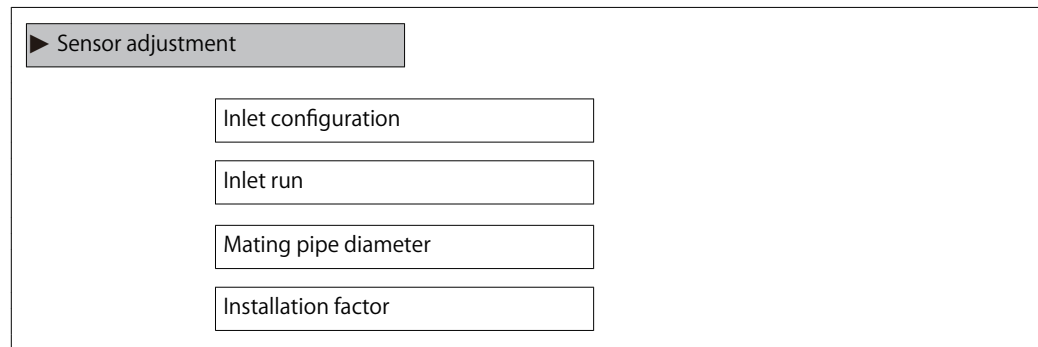

Parameter overview with brief description

Parameter	Prerequisite	Description	Selection / User entry	Factory setting
Inlet configuration	The inlet run correction feature: <ul style="list-style-type: none"> Is a standard feature and can only be used in EF200R-C. Can be used for the following pressure ratings and nominal diameters: DN 15 to 150 (1 to 6") <ul style="list-style-type: none"> EN (DIN) ASME B16.5, Sch. 40/80 	Select inlet configuration.	<ul style="list-style-type: none"> Off Single elbow Double elbow Double elbow 3D Reduction 	Off
Inlet run	The inlet run correction feature: <ul style="list-style-type: none"> Is a standard feature and can only be used in EF200R-C. Can be used for the following pressure ratings and nominal diameters: DN 15 to 150 (1 to 6") <ul style="list-style-type: none"> EN (DIN) ASME B16.5, Sch. 40/80 	Define length of the straight inlet run. Dependency The unit is taken from the Length unit parameter	0 to 20 m	0 m
Mating pipe diameter	–	Enter diameter of mating pipe to enable diameter mismatch correction. Detailed information on diameter mismatch correction: → See 10.5.3 Dependency The unit is taken from the Length unit parameter.	0 to 1 m (0 to 3 ft) Input value = 0: Diameter mismatch correction is disabled.	Country-specific: <ul style="list-style-type: none"> 0 m 0 ft
Installation factor	–	Enter factor to adjust for installation conditions.	Positive floating-point number	1.0

Diameter mismatch correction

 The measuring device is calibrated according to the ordered process connection. This calibration takes account of the edge at the transition from the mating pipe to the process connection. If the mating pipe used deviates from the ordered process connection, a diameter mismatch correction can compensate for the effects. The difference between the internal diameter of the ordered process connection and the internal diameter of the mating pipe used must be taken into consideration.

The measuring device can correct shifts in the calibration factor which are caused, for example, by a diameter mismatch between the device flange (e.g. ASME B16.5/Sch. 80, DN 50 (2")) and the mating pipe (e.g. ASME B16.5/Sch. 40, DN 50 (2")). Only apply diameter mismatch correction within the following limit values (listed below) for which test measurements have also been performed.

Flange connection:

- DN 15 (½"): ±20 % of the internal diameter
- DN 25 (1"): ±15 % of the internal diameter
- DN 40 (1½"): ±12 % of the internal diameter
- DN ≥ 50 (2"): ±10 % of the internal diameter

If the standard internal diameter of the ordered process connection differs from the internal diameter of the mating pipe, an additional measuring uncertainty of approx. 2 % o.r. must be expected.

Example

Influence of the diameter mismatch without using the correction function:

- Mating pipe DN 100 (4"), Schedule 80
- Device flange DN 100 (4"), Schedule 40
- This installation position results in a diameter mismatch of 5 mm (0.2 in). If the correction function is not used, an additional measuring uncertainty of approx. 2 % o.r. must be expected.
- If the basic conditions are met and the feature is enabled, the additional measuring uncertainty is 1 % o.r.

10.5.4 Configuring the totalizer

In the "Totalizer 1 to n" submenu the individual totalizer can be configured.

Navigation

"Setup" menu → Advanced setup → Totalizer 1 to n

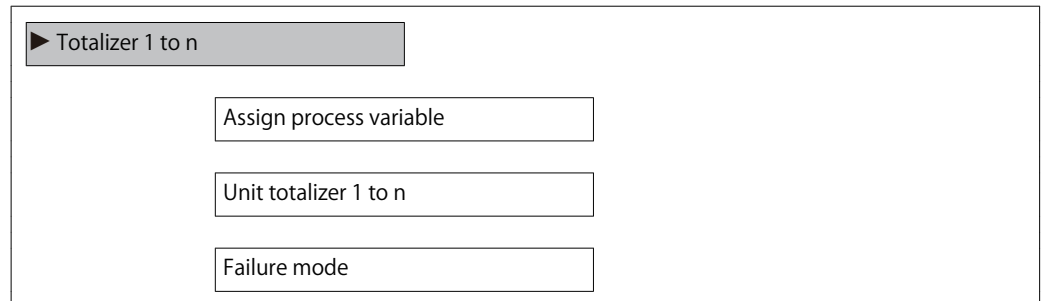

Parameter overview with brief description

Parameter	Prerequisite	Description	Selection	Factory setting
Assign process variable	–	Select process variable for totalizer.	<ul style="list-style-type: none"> • Off • Volume flow • Corrected volume flow • Mass flow • Total mass flow * • Condensate mass flow * • Energy flow * • Heat flow difference * 	<ul style="list-style-type: none"> • Totalizer 1: Volume flow • Totalizer 2: Mass flow • Totalizer 3: Corrected volume flow
Unit totalizer 1 to n	A process variable is selected in the Assign process variable parameter (→ See 11.6) of the Totalizer 1 to n submenu.	Select process variable totalizer unit.	Unit choose list	Country-specific: <ul style="list-style-type: none"> • m³ • ft³
Totalizer operation mode	A process variable is selected in the Assign process variable parameter of the Totalizer 1 to n submenu.	Select totalizer calculation mode.	<ul style="list-style-type: none"> • Net flow total • Forward flow total • Reverse flow total 	Net flow total
Failure mode	A process variable is selected in the Assign process variable parameter (→ See 10.4.5) of the Totalizer 1 to n submenu.	Define totalizer behavior in alarm condition.	<ul style="list-style-type: none"> • Stop • Actual value • Last valid value 	Stop

* Visibility depends on order options or device settings

10.5.5 Carrying out additional display configurations

In the Display submenu you can set all the parameters associated with the configuration of the local display.

Navigation

"Setup" menu → Advanced setup → Display

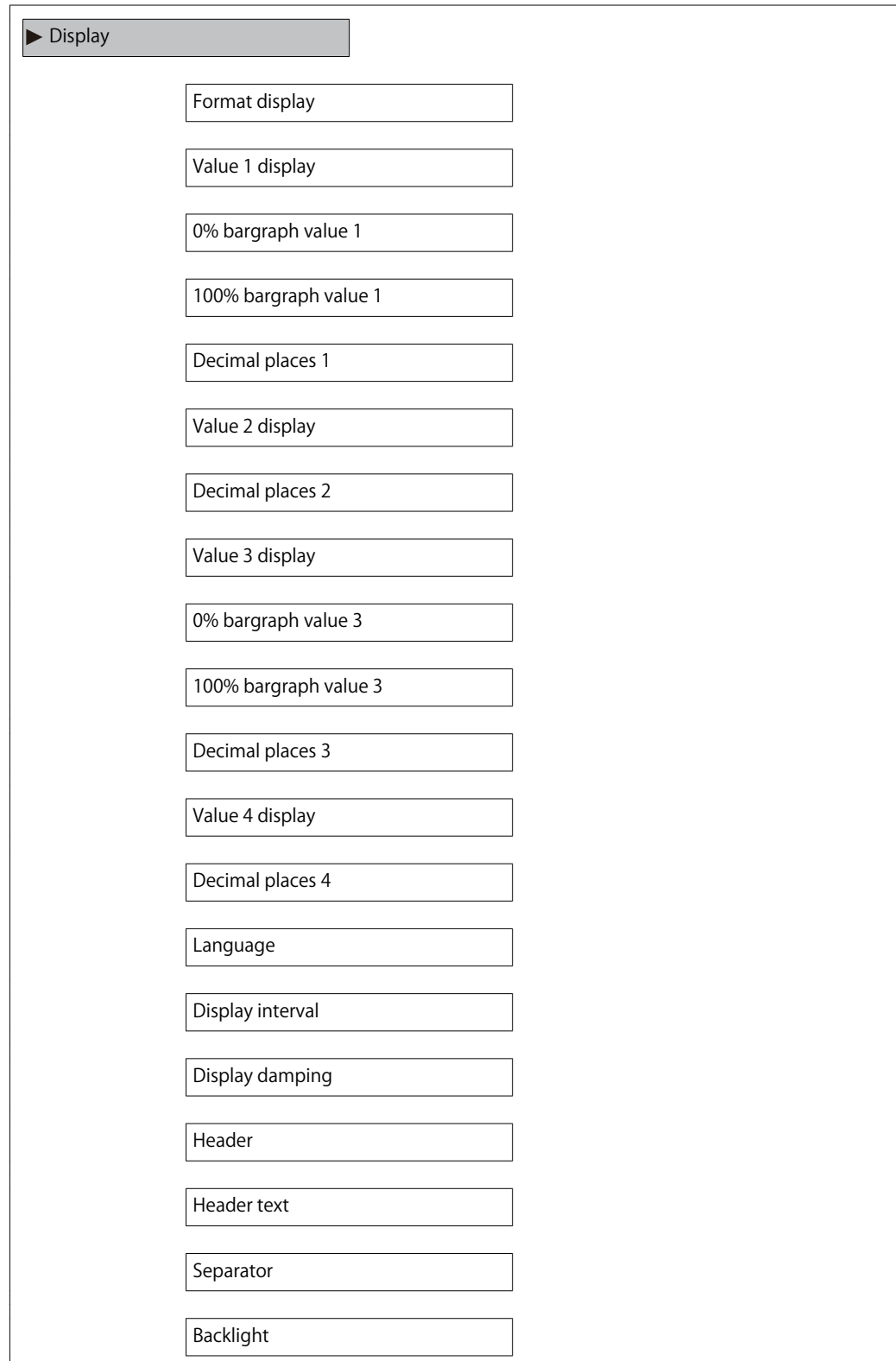

The image shows a screenshot of a configuration menu titled "Display". The menu is contained within a rectangular frame. At the top left, there is a grey header bar with a right-pointing triangle and the text "Display". Below this header, there is a vertical list of 18 rectangular input fields, each containing a text label. The labels are: "Format display", "Value 1 display", "0% bargraph value 1", "100% bargraph value 1", "Decimal places 1", "Value 2 display", "Decimal places 2", "Value 3 display", "0% bargraph value 3", "100% bargraph value 3", "Decimal places 3", "Value 4 display", "Decimal places 4", "Language", "Display interval", "Display damping", "Header", "Header text", "Separator", and "Backlight".

▶ Display
Format display
Value 1 display
0% bargraph value 1
100% bargraph value 1
Decimal places 1
Value 2 display
Decimal places 2
Value 3 display
0% bargraph value 3
100% bargraph value 3
Decimal places 3
Value 4 display
Decimal places 4
Language
Display interval
Display damping
Header
Header text
Separator
Backlight

Parameter overview with brief description

Parameter	Prerequisite	Description	Selection / User entry	Factory setting
Format display	A local display is provided.	Select how measured values are shown on the display.	<ul style="list-style-type: none"> • 1 value, max. size • 1 bargraph + 1 value • 2 values • 1 value large + 2 values • 4 values 	1 value, max. size
Value 1 display	A local display is provided.	Select the measured value that is shown on the local display.	<ul style="list-style-type: none"> • Volume flow • Corrected volume flow • Mass flow • Flow velocity • Temperature • Calculated saturated steam pressure* • Steam quality* • Total mass flow* • Condensate mass flow* • Energy flow* • Heat flow difference* • Reynolds number* • Density* • Pressure* • Specific volume* • Degrees of superheat* • Totalizer 1 • Totalizer 2 • Totalizer 3 • Current output 1 • Current output 2* 	Volume flow
0% bargraph value 1	A local display is provided.	Enter 0% value for bar graph display.	Signed floating-point number	Country-specific: <ul style="list-style-type: none"> • 0 m³/h • 0 ft³/h
100% bargraph value 1	A local display is provided.	Enter 100% value for bar graph display.	Signed floating-point number	Depends on country and nominal diameter
Decimal places 1	A measured value is specified in the Value 1 display parameter.	Select the number of decimal places for the display value.	<ul style="list-style-type: none"> • x • x.x • x.xx • x.xxx • x.xxxx 	x.xx
Value 2 display	A local display is provided.	Select the measured value that is shown on the local display.	For the picklist, see the Value 1 display parameter	None
Decimal places 2	A measured value is specified in the Value 2 display parameter.	Select the number of decimal places for the display value.	<ul style="list-style-type: none"> • x • x.x • x.xx • x.xxx • x.xxxx 	x.xx
Value 3 display	A local display is provided.	Select the measured value that is shown on the local display.	For the picklist, see the Value 1 display parameter	None
0% bargraph value 3	A selection was made in the Value 3 display parameter.	Enter 0% value for bar graph display.	Signed floating-point number	Country-specific: <ul style="list-style-type: none"> • 0 m³/h • 0 ft³/h

Parameter	Prerequisite	Description	Selection / User entry	Factory setting
100% bargraph value 3	A selection was made in the Value 3 display parameter.	Enter 100% value for bar graph display.	Signed floating-point number	0
Decimal places 3	A measured value is specified in the Value 3 display parameter.	Select the number of decimal places for the display value.	<ul style="list-style-type: none"> • x • x.x • x.xx • x.xxx • x.xxxx 	x.xx
Value 4 display	A local display is provided.	Select the measured value that is shown on the local display.	For the picklist, see the Value 1 display parameter	None
Decimal places 4	A measured value is specified in the Value 4 display parameter.	Select the number of decimal places for the display value.	<ul style="list-style-type: none"> • x • x.x • x.xx • x.xxx • x.xxxx 	x.xx
Language	A local display is provided.	Set display language.	<ul style="list-style-type: none"> • English • Deutsch * • Français * • Español * • Italiano * • Nederlands * • Portuguesa * • Polski * • русский язык (Russian) * • Svenska * • Türkçe * • 中文 (Chinese) * • 日本語 (Japanese) * • 한국어 (Korean) * • العربية (Arabic) * • Bahasa Indonesia * • Thai • tiếng Việt (Vietnamese) * • čeština (Czech) * 	English (alternatively, the ordered language is preset in the device)
Display interval	A local display is provided.	Set time measured values are shown on display if display alternates between values.	1 to 10 s	5 s
Display damping	A local display is provided.	Set display reaction time to fluctuations in the measured value.	0.0 to 999.9 s	0.0 s
Header	A local display is provided.	Select header contents on local display.	<ul style="list-style-type: none"> • Device tag • Free text 	Device tag
Header text	In the Header parameter, the Free text option is selected.	Enter display header text.	Max. 12 characters such as letters, numbers or special characters (e.g. @, %, /)	-----
Separator	A local display is provided.	Select decimal separator for displaying numerical values.	<ul style="list-style-type: none"> • . (point) • , (comma) 	.(point)

* Visibility depends on order options or device settings

10.5.6 Configuration management

After commissioning, you can save the current device configuration, copy it to another measuring point or restore the previous device configuration.

You can do so using the Configuration management parameter and the related options found in the Configuration backup display submenu.

Navigation

"Setup" menu → Advanced setup → Configuration backup display

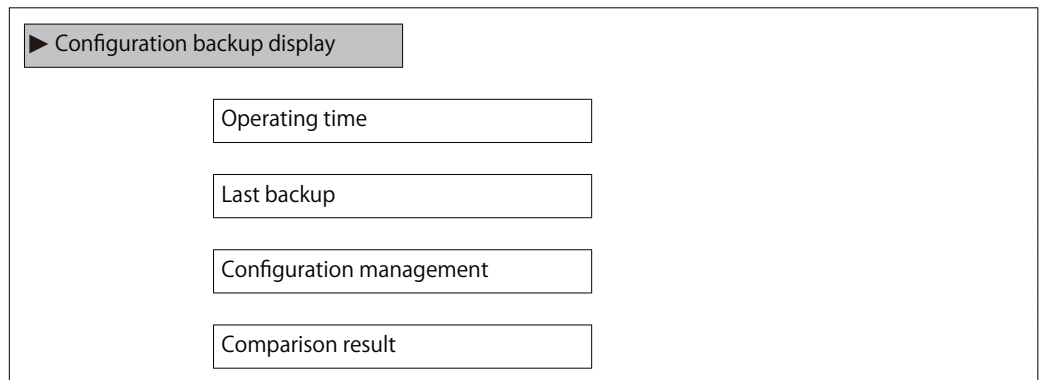

Parameter overview with brief description

Parameter	Prerequisite	Description	User interface / Selection	Factory setting
Operating time	–	Indicates how long the device has been in operation.	Days (d), hours (h), minutes (m) and seconds (s)	–
Last backup	A local display is provided.	Indicates when the last data backup was saved to the display module.	Days (d), hours (h), minutes (m) and seconds (s)	–
Configuration management	A local display is provided.	Select action for managing the device data in the display module.	<ul style="list-style-type: none"> • Cancel • Execute backup • Restore • Duplicate • Compare • Clear backup data 	Cancel
Comparison result	A local display is provided.	Comparison between present device data and display backup.	<ul style="list-style-type: none"> • Settings identical • Settings not identical • No backup available • Backup settings corrupt • Check not done • Dataset incompatible 	Check not done

Function scope of the "Configuration management" parameter

Options	Description
Cancel	No action is executed and the user exits the parameter.
Execute backup	A backup copy of the current device configuration is saved from the HistoROM backup to the display module of the device. The backup copy includes the transmitter data of the device.

Options	Description
Restore	The last backup copy of the device configuration is restored from the display module to the device's HistoROM backup. The backup copy includes the transmitter data of the device.
Compare	The device configuration saved in the display module is compared with the current device configuration of the HistoROM backup.
Duplicate	The transmitter configuration from another device is duplicated to the device using the display module.
Clear backup data	The backup copy of the device configuration is deleted from the display module of the device.

i HistoROM backup
A HistoROM is a "non-volatile" device memory in the form of an EEPROM.

i While this action is in progress, the configuration cannot be edited via the local display and a message on the processing status appears on the display.

10.5.7 Using parameters for device administration

The Administration submenu systematically guides the user through all the parameters that can be used for device administration purposes.

Navigation

"Setup" menu → Advanced setup → Administration

The screenshot shows a menu structure for device administration. At the top is a grey bar with a right-pointing arrow and the text 'Administration'. Below this, there are four more grey bars, each with a right-pointing arrow and text: 'Define access code', 'Define access code', 'Confirm access code', and 'Device reset'. Below each of these grey bars is a white rectangular input field corresponding to the text above it.

Parameter overview with brief description

Parameter	Description	User entry / Selection	Factory setting
Define access code	Restrict write-access to parameters to protect the configuration of the device against unintentional changes via the local display.	0 to 9999	0
Confirm access code	Confirm the entered access code.	0 to 9999	0
Device reset	Reset the device configuration - either entirely or in part - to a defined state.	<ul style="list-style-type: none"> • Cancel • To factory defaults* • To delivery settings* • Restart device 	Cancel

* "Factory defaults" and "Delivery settings" are initial settings provided by an OEM supplier. These settings are different from those set at the TLV factory.

10.6 Configuration management

After commissioning, you can save the current device configuration, copy it to another measuring point or restore the previous device configuration.

You can do so using the Configuration management parameter and the related options found in the Configuration backup display submenu.

Navigation

"Setup" menu → Advanced setup → Configuration backup display

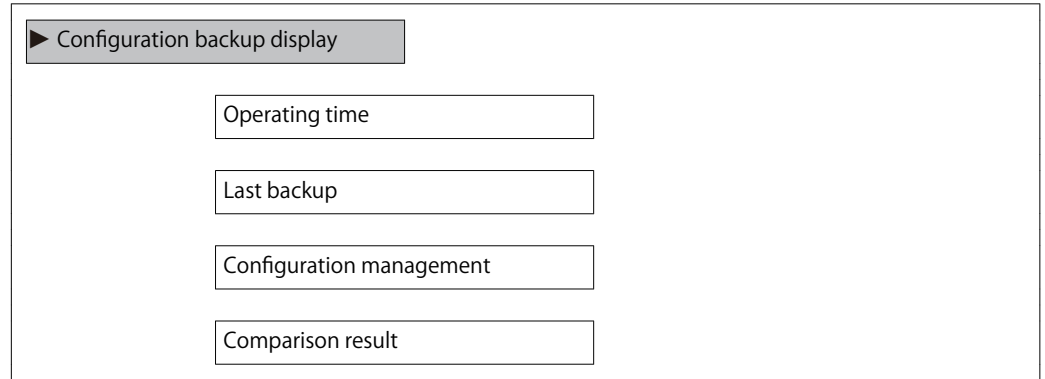

Parameter overview with brief description

Parameter	Prerequisite	Description	User interface / Selection	Factory setting
Operating time	–	Indicates how long the device has been in operation.	Days (d), hours (h), minutes (m) and seconds (s)	–
Last backup	A local display is provided.	Indicates when the last data backup was saved to the display module.	Days (d), hours (h), minutes (m) and seconds (s)	–
Configuration management	A local display is provided.	Select action for managing the device data in the display module.	<ul style="list-style-type: none"> • Cancel • Execute backup • Restore • Duplicate • Compare • Clear backup data 	Cancel
Comparison result	A local display is provided.	Comparison between present device data and display backup.	<ul style="list-style-type: none"> • Settings identical • Settings not identical • No backup available • Backup settings corrupt • Check not done • Dataset incompatible 	Check not done

10.6.1 Function scope of the "Configuration management" parameter

Options	Description
Cancel	No action is executed and the user exits the parameter.
Execute backup	A backup copy of the current device configuration is saved from the HistoROM backup to the display module of the device. The backup copy includes the transmitter data of the device.
Restore	The last backup copy of the device configuration is restored from the display module to the device's HistoROM backup. The backup copy includes the transmitter data of the device.
Compare	The device configuration saved in the display module is compared with the current device configuration of the HistoROM backup.

Options	Description
Duplicate	The transmitter configuration from another device is duplicated to the device using the display module.
Clear backup data	The backup copy of the device configuration is deleted from the display module of the device.

i **HistoROM backup**
A HistoROM is a "non-volatile" device memory in the form of an EEPROM.

i While this action is in progress, the configuration cannot be edited via the local display and a message on the processing status appears on the display.

10.7 Simulation

The Simulation submenu enables you to simulate, without a real flow situation, various process variables in the process and the device alarm mode and to verify downstream signal chains (switching valves or closed-control loops).

Navigation

"Diagnostics" menu → Simulation

▶ Simulation

Assign simulation process variable

Process variable value

Current input 1 simulation

Value current input 1

Current output 1 to n simulation

Value current output 1 to n

Frequency output simulation

Frequency value

Pulse output simulation

Pulse value

Switch output simulation

Switch status

Device alarm simulation

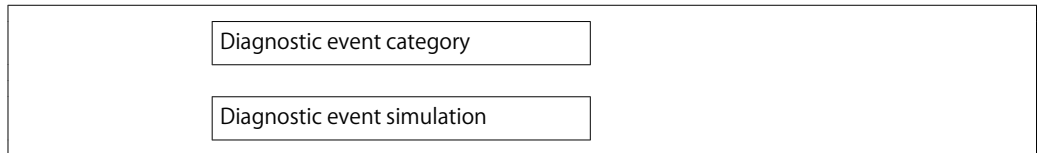

Parameter overview with brief description

Parameter	Prerequisite	Description	Selection / User entry	Factory setting
Assign simulation process variable	–	Select a process variable for the simulation process that is activated.	<ul style="list-style-type: none"> • Off • Mass flow • Flow velocity • Volume flow • Corrected volume flow • Temperature • Calculated saturated steam pressure* • Steam quality* • Total mass flow* • Condensate mass flow* • Energy flow • Heat flow difference* • Reynolds number 	Off
Process variable value	A process variable is selected in the Assign simulation process variable parameter.	Enter the simulation value for the selected process variable.	Depends on the process variable selected	0
Current input 1 simulation	–	Switch simulation of the current input on and off.	<ul style="list-style-type: none"> • Off • On 	Off
Value current input 1	In the Current input simulation parameter, the On option is selected.	Enter the current value for simulation.	3.59 to 22.5 mA	3.59 mA
Current output 1 to n simulation	–	Switch the simulation of the current output on and off.	<ul style="list-style-type: none"> • Off • On 	Off
Value current output 1 to n	In the Current output 1 to n simulation parameter, the On option is selected.	Enter the current value for simulation.	3.59 to 22.5 mA	3.59 mA
Frequency output simulation	In the Operating mode parameter, the Frequency option is selected.	Switch the simulation of the frequency output on and off.	<ul style="list-style-type: none"> • Off • On 	Off
Frequency value	In the Frequency output simulation parameter, the On option is selected.	Enter the frequency value for the simulation.	0.0 to 1 250.0 Hz	0.0 Hz
Pulse output simulation	In the Operating mode parameter, the Pulse option is selected.	Set and switch off the pulse output simulation.  For Fixed value option: Pulse width parameter (→ See 10.4.6) defines the pulse width of the pulses output.	<ul style="list-style-type: none"> • Off • Fixed value • Down-counting value 	Off
Pulse value	In the Pulse output simulation parameter, the Down-counting value option is selected.	Enter the number of pulses for simulation.	0 to 65 535	0

Parameter	Prerequisite	Description	Selection / User entry	Factory setting
Switch output simulation	In the Operating mode parameter, the Switch option is selected.	Switch the simulation of the switch output on and off.	<ul style="list-style-type: none"> • Off • On 	Off
Switch status	In the Switch output simulation parameter Switch output simulation 1 to n simulation Switch output simulation 1 to n parameter, the On option is selected.	Select the status of the status output for the simulation.	<ul style="list-style-type: none"> • Open • Closed 	Open
Device alarm simulation	–	Switch the device alarm on and off.	<ul style="list-style-type: none"> • Off • On 	Off
Diagnostic event category	–	Select a diagnostic event category.	<ul style="list-style-type: none"> • Sensor • Electronics • Configuration • Process 	Process
Diagnostic event simulation	–	Select a diagnostic event to simulate this event.	<ul style="list-style-type: none"> • Off • Diagnostic event picklist (depends on the category selected) 	Off

* Visibility depends on order options or device settings

10.8 Protecting settings from unauthorized access

The following options exist for protecting the configuration of the measuring device from unintentional modification after commissioning:

- Write protection via access code
- Write protection via write protection switch
- Write protection via keypad lock

10.8.1 Write protection via access code

The effects of the user-specific access code are as follows:

- Via local operation, the parameters for the measuring device configuration are write-protected and their values can no longer be changed.
- Device access is protected via the Web browser, as are the parameters for the measuring device configuration.

Defining the access code via local display

1. Navigate to the Enter access code parameter.
2. Define a max. 16-digit character string comprising numbers, letters and special characters as the access code.
3. Enter the access code again in the to confirm the code.
 - ↳ The -symbol appears in front of all write-protected parameters.

The device automatically locks the write-protected parameters again if a key is not pressed for 10 minutes in the navigation and editing view. The device locks the write-protected

parameters automatically after 60 s if the user skips back to the operational display mode from the navigation and editing view.

- i** • If parameter write protection is activated via an access code, it can also only be deactivated via this access code → See 8.3.11
- The user role with which the user is currently logged on via the local display → See 8.3.10 is indicated by the Access status display parameter. Navigation path: Operation → Access status display

Parameters which can always be modified via the local display

Certain parameters that do not affect the measurement are excepted from parameter write protection via the local display. Despite the user-specific access code, they can always be modified, even if the other parameters are locked.

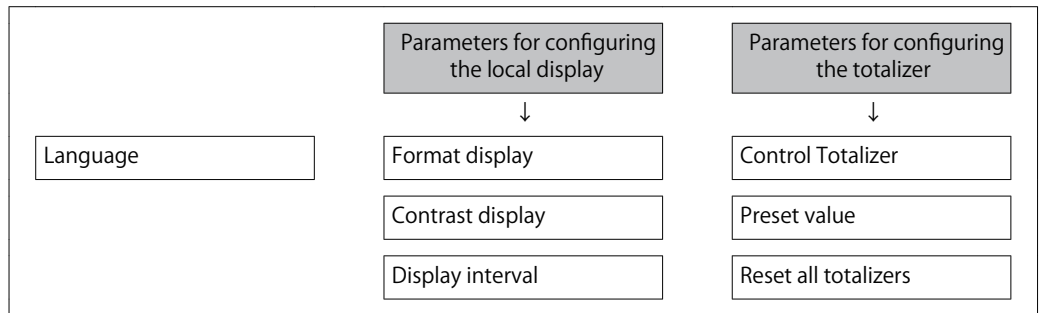

10.8.2 Write protection via write protection switch

Unlike parameter write protection via a user-specific access code, this allows write access to the entire operating menu - except for the "Contrast display" parameter - to be locked.

The parameter values are now read only and cannot be edited any more (exception "Contrast display" parameter):

- Via local display
- Via service interface (CDI)
- Via HART protocol

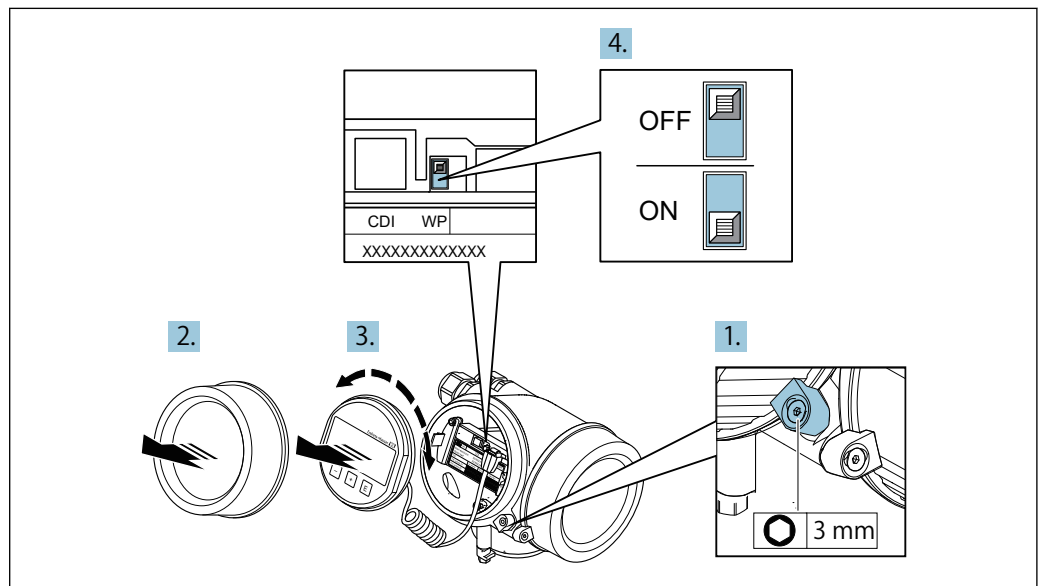

1. Loosen the securing clamp.
2. Unscrew the electronics compartment cover.

A0032230

3. Pull out the display module with a gentle rotational movement. To make it easier to access the write protection switch, attach the display module to the edge of the electronics compartment.
 - ↳ Display module is attached to the edge of the electronics compartment.

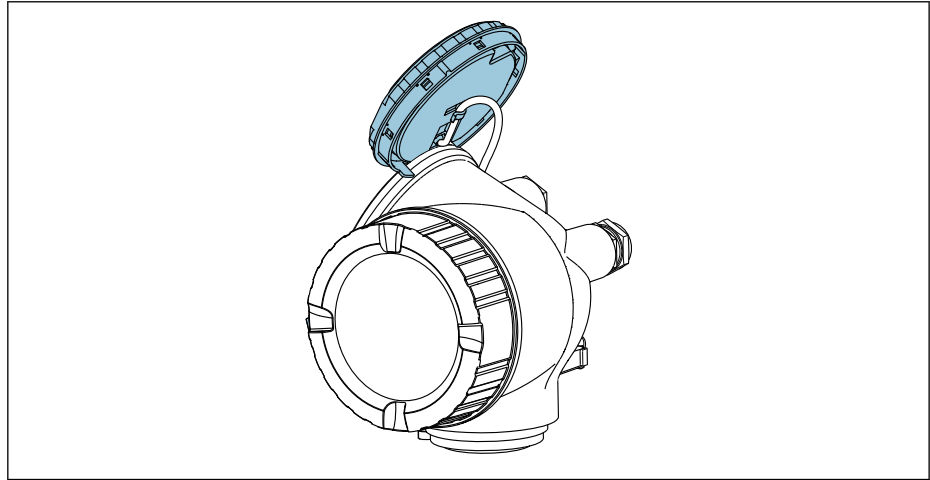

A0032236

4. Setting the write protection switch (WP) on the main electronics module to the ON position enables hardware write protection. Setting the write protection switch (WP) on the main electronics module to the OFF position (factory setting) disables hardware write protection.
 - ↳ If the hardware write protection is enabled: The Hardware locked option is displayed in the Locking status parameter . In addition, on the local display the -symbol appears in front of the parameters in the header of the operational display and in the navigation view.

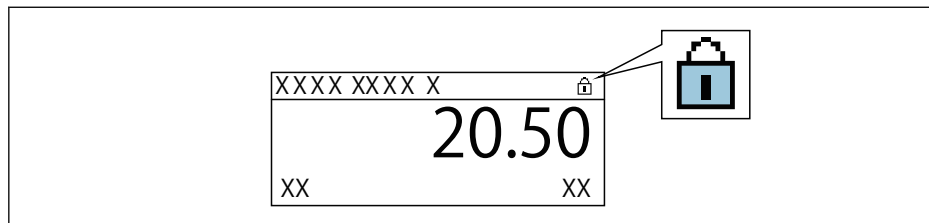

A0029425

If the hardware write protection is disabled: No option is displayed in the Locking status parameter . On the local display, the -symbol disappears from in front of the parameters in the header of the operational display and in the navigation view.

5. Feed the cable into the gap between the housing and main electronics module and plug the display module into the electronics compartment in the desired direction until it engages.
6. Reverse the removal procedure to reassemble the transmitter.

10.9 Application-specific commissioning

 This product is intended for use with steam, water and air.

10.9.1 Steam application

Select medium

Navigation:

Setup → Medium selection

1. Call up the Medium selection wizard.

2. In the Select medium parameter, select the Steam option.
3. When pressure measured value is read in:¹⁾
In the Steam calculation mode parameter, select the Automatic (p-/T-compensated) option.
4. If pressure measured value is not read in:
In the Steam calculation mode parameter, select the Saturated steam (T-compensated) option.
5. In the Steam quality value parameter, enter the steam quality present in the pipe.
 - ↳ Without Wet Steam Detection/Measurement application package: Measuring device uses this value to calculate the mass flow of the steam.
 - With Wet Steam Detection/Measurement application package: Measuring device uses this value if the steam quality cannot be calculated (steam quality is not compliant with basic conditions).

Configuring the current output

6. Configure current output → See 10.4.5.

Configuring the external compensation

7. With Wet Steam Detection/Measurement application package:
In the Steam quality parameter, select the Calculated value option.



For detailed information on the basic conditions for wet steam applications, see the Special Documentation.

10.9.2 Liquid application

User-specific liquid, e. g. heat carrier oil

Select medium

Navigation:

Setup → Medium selection

1. Call up the Medium selection wizard.
2. In the Select medium parameter, select the Liquid option.
3. In the Select liquid type parameter, select the User-specific liquid option.
4. In the Enthalpy type parameter, select the Heat option.
 - ↳ Heat option: Non-flammable liquid that serves as a heat carrier.
 - Calorific value option: Flammable liquid whose combustion energy is calculated.

Configuring fluid properties

Navigation:

Setup → Advanced setup → Medium properties

5. Call up the Medium properties submenu.
6. In the Reference density parameter, enter the reference density of the fluid.
7. In the Reference temperature parameter, enter the fluid temperature associated with the reference density.
8. In the Linear expansion coefficient parameter, enter the expansion coefficient of the fluid.
9. In the Specific heat capacity parameter, enter the heat capacity of the fluid.

1) Sensor version option "mass (integrated pressure and temperature measurement)", Pressure read in via current input/HART/

10. In the Dynamic viscosity parameter, enter the viscosity of the fluid.

10.9.3 Gas applications

- i** For accurate mass or corrected volume measurement, it is recommended to use the pressure-/temperature-compensated sensor version.
If neither of these two options is possible, the pressure can also be entered as a fixed value in the Fixed process pressure parameter.

Air

Select medium

Navigation:

Setup → Medium selection

1. Call up the Medium selection wizard.
2. In the Select medium parameter (→ See 10.4.3), select the Gas option.
3. In the Select gas type parameter (→ See 10.4.3), select the Air option.
↳ The density is determined according to NEL 40.
4. Enter the value in the Relative humidity parameter (→ See 10.4.3).
↳ The relative humidity is entered as a %. The relative humidity is converted internally to absolute humidity and is then factored into the density calculation according to NEL 40.
5. In the Fixed process pressure parameter (→ See 10.4.3), enter the value of the process pressure present.

Configuring fluid properties

Navigation:

Setup → Advanced setup → Medium properties

6. Call up the Medium properties submenu.
7. In the Reference pressure parameter (→ See 10.5.1) enter the reference pressure for calculating the reference density.
↳ Pressure that is used as a static reference for combustion. This makes it possible to compare combustion processes at different pressures.
8. In the Reference temperature parameter (→ See 10.5.1) enter the temperature for calculating the reference density.

10.9.4 Calculation of the measured variables

A flow computer can be found in the electronics of the measuring device with order code for "Sensor version", option "mass (integrated temperature measurement)" and option "mass (integrated pressure/temperature measurement)". This computer can calculate the following secondary measured variables directly from the primary measured variables recorded using the pressure value (entered or external) and/or temperature value (measured or entered).

Mass flow and corrected volume flow

Medium	Fluid	Standards	Explanation
Steam ¹⁾	Water vapor	IAPWS-IF97/ ASME	<ul style="list-style-type: none"> • For integrated temperature measurement • For fixed process pressure.
Gas	Air	NEL40	For fixed process pressure.
Liquids	Water	IAPWS-IF97/ ASME	–

- 1) The measuring device is capable of calculating the volume flow, and other measured variables derived from the volume flow, across all steam types with full compensation using the pressure and temperature. To configure device behavior → See 10.5.2

Mass flow calculation

Volume flow × operating density

- Operating density for saturated steam, water and other liquids: depends on the temperature
- Operating density for superheated steam and all other gases: depends on the temperature and process pressure

Corrected volume flow calculation

(Volume flow × operating density)/reference density

- Operating density for water and other liquids: depends on the temperature
- Operating density for all other gases: depends on the temperature and process pressure

Energy flow

Medium	Fluid	Standards	Explanation	Heat/energy option
Steam ¹⁾	–	IAPWS-IF97/ASME	For fixed process pressure or if the pressure is read in via current input/HART	Heat Gross calorific value ²⁾ in relation to mass Net calorific value ³⁾ in relation to mass Gross calorific value ²⁾ in relation to corrected volume Net calorific value ³⁾ in relation to corrected volume
Gas	Air	NEL40	For fixed process pressure.	
Liquids	Water	IAPWS-IF97/ASME	–	

- 1) The measuring device is capable of calculating the volume flow, and other measured variables derived from the volume flow, across all steam types with full compensation using the pressure and temperature. To configure device behavior → See 10.5.2
- 2) Gross calorific value: combustion energy + condensation energy of the flue gas (gross calorific value > net calorific value)
- 3) Net calorific value: only combustion energy

Mass flow and energy flow calculation

NOTICE

The process pressure (p) in the process pipe is required to calculate the process variables and the limit values of the measuring range.

- ▶ With the HART device, the process pressure can be entered via the 4 to 20mA current input or via HART from an external pressure measuring device (e. g. Cerabar M) or entered as a fixed value in the External compensation submenu (→ See 10.5.2).

Steam is calculated based on the following factors:

- Fully compensated calculation of density using the "pressure" and "temperature" measured variables
- Calculation based on overheated steam until saturation point is reached
Configuration of diagnostic behavior of the \triangle S871 Near steam saturation limit diagnostic message Assign behavior of diagnostic no. 871 parameter set to Off option (factory setting) as standard → See 12.3.1
Optional configuration of diagnostic behavior to the Alarm option or Warning option → See 12.3.1 option.
At 2 K above saturation, activation of the \triangle S871 Near steam saturation limit diagnostic message.
- The smaller of the following two pressure values is always used to calculate the density:
 - Pressure measured directly at meter body or pressure read in via current input/HART
 - Saturated steam pressure, which is derived from the saturated steam line (IAPWS-IF97/ASME)
- Depending on setting in the Steam calculation mode parameter (→ See 10.4.3)
 - If Saturated steam (T-compensated) option is selected, the measuring device only calculates on the saturated steam curve using temperature compensation.
 - If Automatic (p-/T-compensated) option is selected, the device calculates using full compensation either along the saturation line or in the superheated region, depending on the steam state.
 - If Automatic (p-/T-compensated) option is selected in combination with one of the application packages wet steam detection or wet steam measurement, the measuring device can also calculate in the wet steam region.



For detailed information on how to perform external compensation, see → See 10.5.2.

Calculated value

The unit calculates the mass flow, heat flow, energy flow, density and specific enthalpy from the measured volume flow and the measured temperature and/or the pressure based on international standard IAPWS-IF97/ASME.

Formulae for calculation:

- Mass flow: $\dot{m} = \dot{v} \times \rho (T, p)$
- Heat flow: $\dot{Q} = \dot{v} \times \rho (T, p) \times h_D (T, p)$

\dot{m} = Mass flow

\dot{Q} = Heat flow

\dot{v} = Volume flow (measured)

h_D = Specific enthalpy

T = Process temperature (measured)

p = Process pressure

ρ = Density²⁾

Energy flow calculation

Volume flow \times operating density \times specific enthalpy

- Operating density for saturated steam and water: depends on the temperature
- Operating density for superheated steam, natural gas ISO 6976 (contains GPA 2172), natural gas AGA5: depends on the temperature and pressure

11 Operation

11.1 Reading the device locking status

Device active write protection: Locking status parameter

Operation → Locking status

Function scope of the "Locking status" parameter

Options	Description
None	The access status displayed in the Access status display parameter applies → See 8.3.10. Only appears on local display.
Hardware locked	The DIP switch for hardware locking is activated on the main electronics module. This locks write access to the parameters (e.g. via local display or operating tool)
Temporarily locked	Write access to the parameters is temporarily locked on account of internal processes running in the device (e.g. data upload/download, reset etc.). Once the internal processing has been completed, the parameters can be changed once again.

11.2 Adjusting the operating language

i Detailed information:

- To configure the operating language → See 10.3
- For information on the operating languages supported by the measuring device → See 16.11

11.3 Configuring the display

Detailed information:

- On the basic settings for the local display → See 10.4.7
- On the advanced settings for the local display → See 10.5.5

11.4 Reading measured values

With the Measured values submenu, it is possible to read all the measured values.

Navigation

"Diagnostics" menu → Measured values → Process variables

▶ Measured values	
▶ Process variables	→ See 11.4.1
▶ Totalizer	→ See 11.4.2
▶ Input values	→ See 11.4.3
▶ Output values	→ See 11.4.4

11.4.1 Process variables

The Process variables submenu contains all the parameters needed to display the current measured values for each process variable.

Navigation

"Diagnostics" menu → Measured values → Process variables

The image shows a screenshot of a software interface. At the top left, there is a grey button with a right-pointing triangle and the text 'Process variables'. Below this button is a vertical list of 14 rectangular buttons, each containing a parameter name. The parameters are: Volume flow, Corrected volume flow, Mass flow, Flow velocity, Temperature, Calculated saturated steam pressure, Energy flow, Heat flow difference, Reynolds number, Density, Specific volume, Pressure, Compressibility factor, and Degrees of superheat.

Process Variable
Volume flow
Corrected volume flow
Mass flow
Flow velocity
Temperature
Calculated saturated steam pressure
Energy flow
Heat flow difference
Reynolds number
Density
Specific volume
Pressure
Compressibility factor
Degrees of superheat

Parameter overview with brief description

Parameter	Prerequisite	Description	User interface
Volume flow	–	Displays the volume flow that is currently measured. Dependency The unit is taken from the Volume flow unit parameter (→ See 10.4.2).	Signed floating-point number
Corrected volume flow	–	Displays the corrected volume flow that is currently calculated. Dependency The unit is taken from the Corrected volume flow unit parameter (→ See 10.4.2).	Signed floating-point number
Mass flow	–	Displays the mass flow currently calculated. Dependency The unit is taken from the Mass flow unit parameter (→ See 10.4.2).	Signed floating-point number
Flow velocity	–	Displays the flow velocity that is currently calculated. Dependency The unit is taken from the Velocity unit parameter (→ See 10.4.2).	Signed floating-point number
Temperature	–	Displays the temperature that is currently measured. Dependency The unit is taken from the Temperature unit parameter (→ See 10.4.2).	Signed floating-point number
Calculated saturated steam pressure	• The Steam option is selected in the Select medium parameter (→ See 10.4.3).	Displays the saturated steam pressure that is currently calculated. Dependency The unit is taken from the Pressure unit parameter (→ See 10.4.2).	Signed floating-point number
Energy flow	With order code for "Sensor version": • option "Mass (integrated temperature measurement)" or • option "Mass (integrated pressure/ temperature measurement)"	Displays the energy flow that is currently calculated. Dependency The unit is taken from the Energy flow unit parameter (→ See 10.4.2).	Signed floating-point number
Heat flow difference	• In the Select gas type parameter (→ <input checked="" type="checkbox"/> 79), one of the following options is selected: Single gas Gas mixture Natural gas User-specific gas	Displays the heat flow difference that is currently calculated. Dependency The unit is taken from the Energy flow unit parameter (→ See 10.4.2).	Signed floating-point number
Reynolds number	With order code for "Sensor version": • option "Mass (integrated temperature measurement)" or • option "Mass (integrated pressure/ temperature measurement)"	Displays the Reynolds number that is currently calculated.	Signed floating-point number
Density	With order code for "Sensor version": • Option "Mass (integrated temperature measurement)" or • Option "Mass (integrated pressure/ temperature measurement)"	Displays the density currently measured. Dependency The unit is taken from the Density unit parameter.	Positive floating-point number

Parameter	Prerequisite	Description	User interface
Specific volume	-	Displays the current value for the specific volume. Dependency The unit is taken from the Specific volume unit parameter.	Positive floating-point number
Pressure	The Pressure option is selected in the External value parameter.	Displays the current process pressure. Dependency The unit is taken from the Pressure unit parameter.	0 to 250 bar
Compressibility factor	The Gas option or the Steam option is selected in the Select medium parameter.	Displays the compressibility factor currently calculated.	0 to 2
Degrees of superheat	In the Select medium parameter, the Steam option is selected.	Displays the degree of superheating currently calculated.	0 to 500 K

11.4.2 "Totalizer" submenu

The Totalizer submenu contains all the parameters needed to display the current measured values for every totalizer.

Navigation

"Diagnostics" menu → Measured values → Totalizer

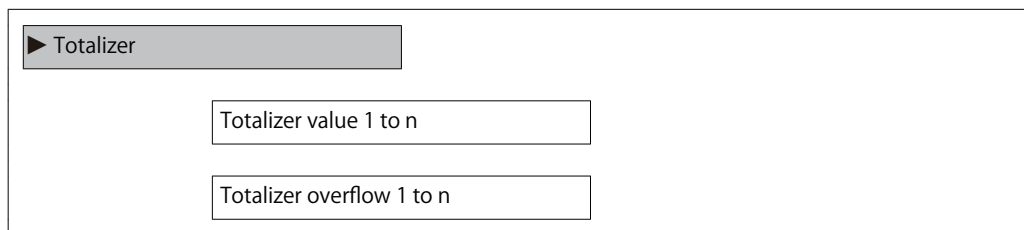

Parameter overview with brief description

Parameter	Prerequisite	Description	User interface
Totalizer value 1 to n	One of the following options is selected in the Assign process variable parameter (→ See 10.5.4) of the Totalizer 1 to n submenu: <ul style="list-style-type: none"> • Volume flow • Corrected volume flow • Mass flow • Total mass flow * • Condensate mass flow * • Energy flow * • Heat flow difference * 	Displays the current totalizer counter value.	Signed floating-point number
Totalizer overflow 1 to n	One of the following options is selected in the Assign process variable parameter (→ See 10.5.4) of the Totalizer1 to n submenu: <ul style="list-style-type: none"> • Volume flow • Corrected volume flow • Mass flow • Total mass flow * • Condensate mass flow * • Energy flow * • Heat flow difference * 	Displays the current totalizer overflow.	Integer with sign

* Visibility depends on order options or device settings

11.4.3 Input values

Not applicable for this version.

11.4.4 Output values

The Output values submenu contains all the parameters needed to display the current measured values for every output.

Navigation

"Diagnostics" menu → Measured values → Output values

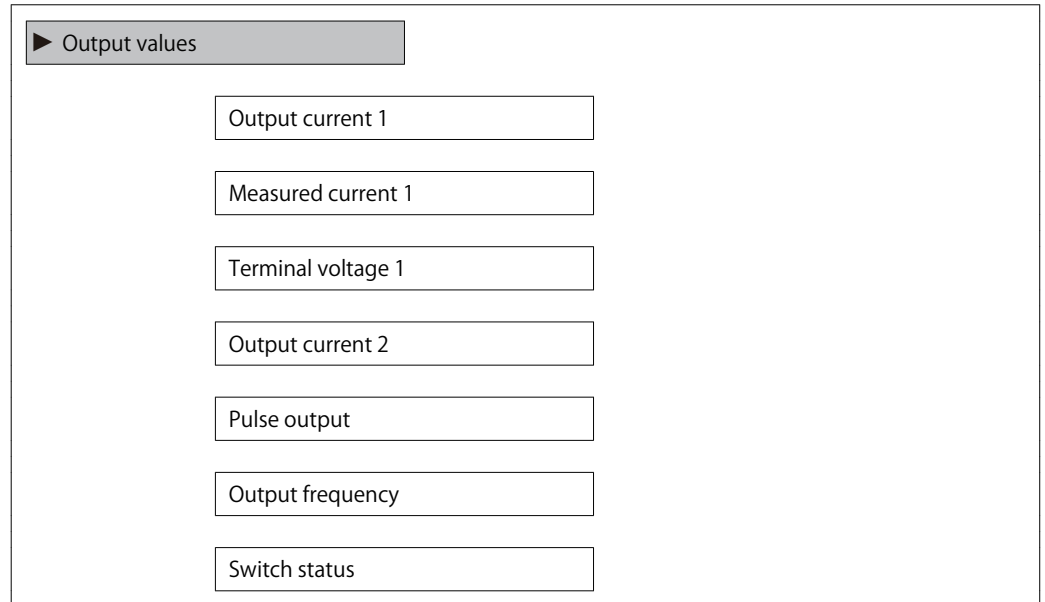

Parameter overview with brief description

Parameter	Prerequisite	Description	User interface
Output current 1	–	Displays the current value currently calculated for the current output.	3.59 to 22.5 mA
Measured current 1	–	Displays the current value currently measured for the current output.	0 to 30 mA
Terminal voltage 1	–	Displays the current terminal voltage that is applied at the output.	0.0 to 50.0 V
Output current 2	–	Displays the current value currently calculated for the current output.	3.59 to 22.5 mA
Pulse output	The Pulse option is selected in the Operating modeparameter parameter.	Displays the pulse frequency currently output.	Positive floating-point number
Output frequency	In the Operating modeparameter, the Frequency option is selected.	Displays the value currently measured for the frequency output.	0 to 1250 Hz
Switch status	The Switch option is selected in the Operating modeparameter.	Displays the current switch output status.	<ul style="list-style-type: none"> • Open • Closed

11.5 Adapting the measuring device to the process conditions

The following are available for this purpose:

- Basic settings using the Setup menu (→ See 10.4)
- Advanced settings using the Advanced setup submenu (→ See 10.5)

11.6 Performing a totalizer reset

The totalizers are reset in the Operation submenu:

- Control Totalizer
- Reset all totalizers

Navigation

"Operation" menu → Totalizer handling

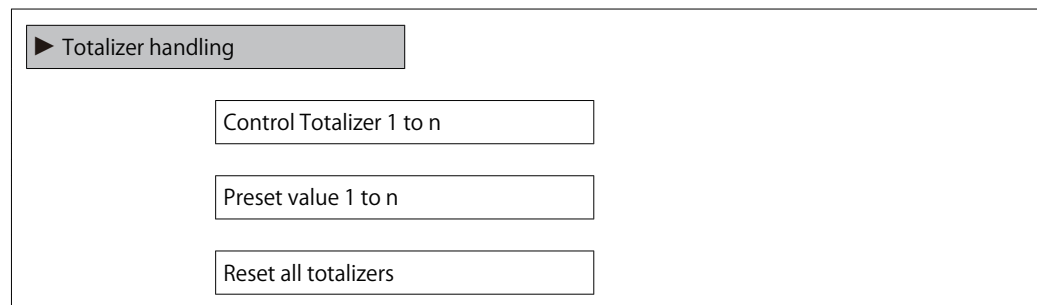

Parameter overview with brief description

Parameter	Prerequisite	Description	Selection / User entry	Factory setting
Control Totalizer 1 to n	A process variable is selected in the Assign process variable parameter (→ See 10.5.4) of the Totalizer 1 to n submenu.	Control totalizer value.	<ul style="list-style-type: none"> • Totalize • Reset + hold • Preset + hold • Reset + totalize • Preset + totalize • Hold 	Totalize
Preset value 1 to n	A process variable is selected in the Assign process variable parameter (→ See 10.5.4) of the Totalizer 1 to n submenu.	Specify start value for totalizer. Dependency  The unit of the selected process variable is specified for the totalizer in the Unit totalizer parameter (→ See 10.5.4).	Signed floating-point number	Country-specific: • 0 m ³ • 0 ft ³
Reset all totalizers	–	Reset all totalizers to 0 and start.	<ul style="list-style-type: none"> • Cancel • Reset + totalize 	Cancel

* Visibility depends on order options or device settings

11.6.1 Function scope of the "Control Totalizer" parameter

Options	Description
Totalize	The totalizer is started or continues running.
Reset + hold	The totaling process is stopped and the totalizer is reset to 0.
Preset + hold	The totaling process is stopped and the totalizer is set to its defined start value from the Preset value parameter.
Reset + totalize	The totalizer is reset to 0 and the totaling process is restarted.
Preset + totalize	The totalizer is set to the defined start value from the Preset value parameter and the totaling process is restarted.

11.6.2 Function scope of the "Reset all totalizers" parameter

Options	Description
Cancel	No action is executed and the user exits the parameter.
Reset + totalize	Resets all totalizers to 0 and restarts the totaling process. This deletes all the flow values previously totalized.

12 Diagnostics and troubleshooting

12.1 General troubleshooting

For local display

Error	Possible causes	Solution
Local display dark and no output signals	Supply voltage does not match the value indicated on the nameplate.	Apply the correct supply voltage → See 7.1.5.
	The polarity of the supply voltage is wrong.	Correct the polarity.
	No contact between connecting cables and terminals.	Check the connection of the cables and correct if necessary.
	Terminals are not plugged into the I/O electronics module correctly.	Check terminals.
	I/O electronics module is defective.	Order spare part → See 14.2 .
Local display dark and output signals in failure current	Sensor short-circuit, electronics module short-circuit	1. Contact service.
Local display is dark, but signal output is within the valid range	Display is set too bright or too dark.	<ul style="list-style-type: none"> Set the display brighter by simultaneously pressing + . Set the display darker by simultaneously pressing + .
Local display is dark, but signal output is within the valid range	The cable of the display module is not plugged in correctly.	Insert the plug correctly into the main electronics module and display module.
Local display is dark, but signal output is within the valid range	Display module is defective.	Order spare part → See 14.2.
Text on local display appears in a foreign language and cannot be understood.	Incorrect operating language is configured.	<ol style="list-style-type: none"> Press + for 2 s ("home position"). Press . Set the desired language in the Display language parameter (→ See 10.5.5).
Message on local display: "Communication Error" "Check Electronics"	Communication between the display module and the electronics is interrupted.	<ul style="list-style-type: none"> Check the cable and the connector between the main electronics module and display module. Order spare part → See 14.2.

For output signals

Error	Possible causes	Solution
Signal output outside the valid range	Main electronics module is defective.	Order spare part → See 14.2.
Signal output outside the valid current range (< 3.6 mA or > 22 mA)	I/O electronics module is defective.	Order spare part → See 14.2 .
Device shows correct value on local display, but signal output is incorrect, though in the valid range.	Configuration error	Check and correct the parameter configuration.
Device measures incorrectly.	Configuration error or device is operated outside the application.	<ol style="list-style-type: none"> Check and correct parameter configuration. Observe limit values specified in the "Technical Data".

For access

Error	Possible causes	Solution
No write access to parameters	Hardware write protection enabled	Set the write protection switch on main electronics module to the OFF position → See 10.8.2.
No write access to parameters	Current user role has limited access authorization	1. Check user role → See 8.3.10. 2. Enter correct customer-specific access code → See 3.10.

12.2 Diagnostic information on local display

12.2.1 Diagnostic message

Faults detected by the self-monitoring system of the measuring device are displayed as a diagnostic message in alternation with the operational display.

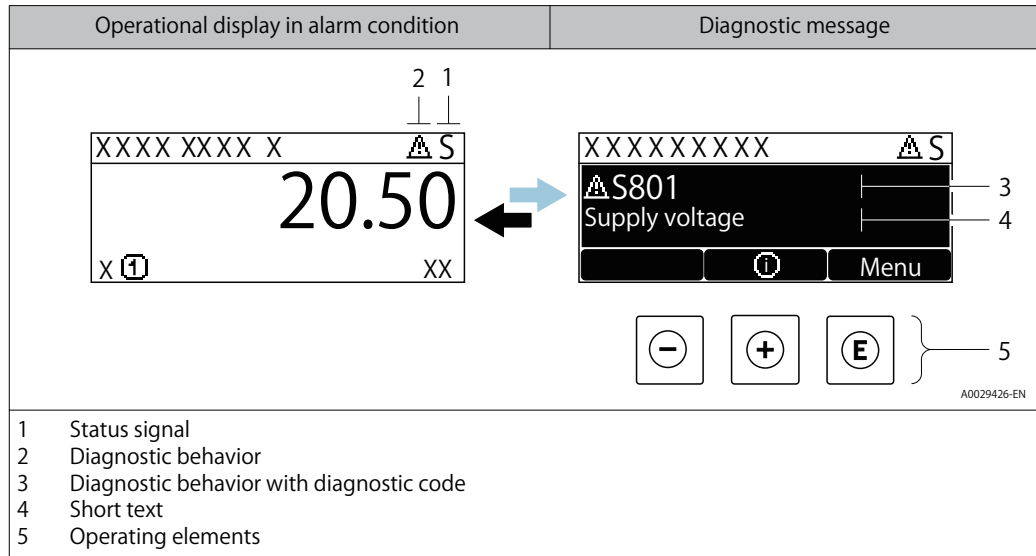

If two or more diagnostic events are pending simultaneously, only the message of the diagnostic event with the highest priority is shown.

- i** Other diagnostic events that have occurred can be displayed in the Diagnostics menu:
 - Via parameter → See 12.7.1
 - Via submenus → See 12.7.1



Status signals

The status signals provide information on the state and reliability of the device by categorizing the cause of the diagnostic information (diagnostic event).

- i** The status signals are categorized according to VDI/VDE 2650 and NAMUR Recommendation NE 107: F = Failure, C = Function Check, S = Out of Specification, M = Maintenance Required

Symbol	Meaning
F	Failure A device error has occurred. The measured value is no longer valid.
C	Function check The device is in service mode (e.g. during a simulation).
S	Out of specification The device is operated: <ul style="list-style-type: none"> • Outside its technical specification limits (e.g. outside the process temperature range) • Outside of the configuration carried out by the user (e.g. maximum flow in parameter 20 mA value)
M	Maintenance required Maintenance is required. The measured value remains valid.

Diagnostic behavior



Symbol	Meaning
	Alarm • Measurement is interrupted. • Signal outputs and totalizers assume the defined alarm condition. • A diagnostic message is generated. • For local display with touch control: the background lighting changes to red.
	Warning Measurement is resumed. The signal outputs and totalizers are not affected. A diagnostic message is generated.

Diagnostic information

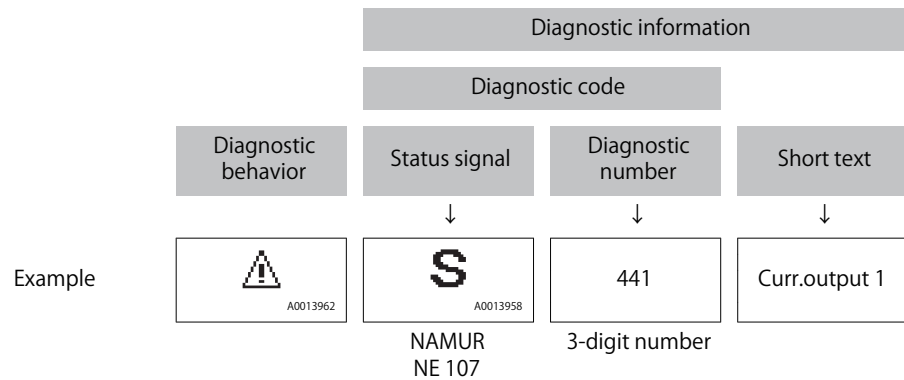
The fault can be identified using the diagnostic information. The short text helps you by providing information about the fault. In addition, the corresponding symbol for the diagnostic behavior is displayed in front of the diagnostic information on the local display.



Operating elements

Key	Meaning
	Plus key In a menu, submenu Opens the message about remedy information.
	Enter key In a menu, submenu Opens the operating menu.

12.2.2 Calling up remedial measures

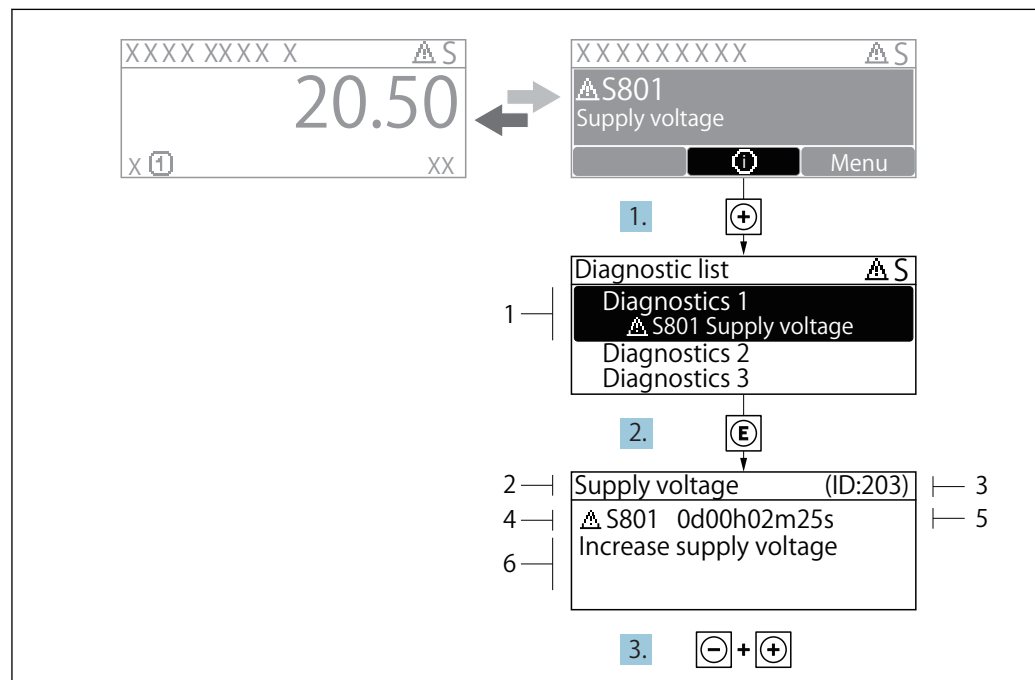

A0029431-EN

Message about remedial measures

- 1 Diagnostic information
- 2 Short text
- 3 Service ID
- 4 Diagnostic behavior with diagnostic code
- 5 Operation time of occurrence
- 6 Remedial measures

1. The user is in the diagnostic message.
Press (symbol).
↳ The Diagnostic list submenu opens.
2. Select the desired diagnostic event with or and press .
3. Press + simultaneously.
↳ The message about the remedial measures closes.

The user is in the Diagnostics menu at an entry for a diagnostics event, e.g. in the Diagnostic list submenu or Previous diagnostics parameter.

1. Press .
- ↳ The message for the remedial measures for the selected diagnostic event opens.
2. Press + simultaneously.
↳ The message for the remedial measures closes.

12.3 Adapting the diagnostic information

12.3.1 Adapting the diagnostic behavior

Each item of diagnostic information is assigned a specific diagnostic behavior at the factory. The user can change this assignment for specific diagnostic information in the Diagnostic behavior submenu.

Expert → System → Diagnostic handling → Diagnostic behavior

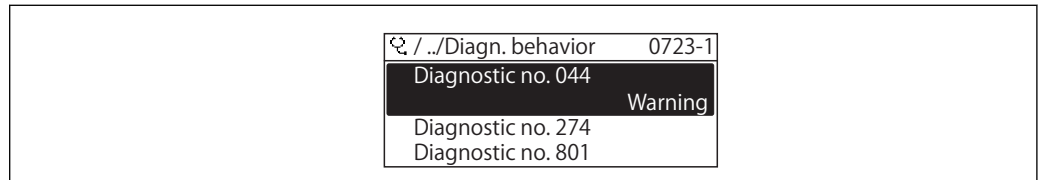

A0014048-EN

Taking the example of the local display

You can assign the following options to the diagnostic number as the diagnostic behavior:

Options	Description
Alarm	The device stops measurement. The signal outputs and totalizers assume the defined alarm condition. A diagnostic message is generated. For local display with touch control: the background lighting changes to red.
Warning	The device continues to measure. The signal outputs and totalizers are not affected. A diagnostic message is generated.
Logbook entry only	The device continues to measure. The diagnostic message is displayed only in the Event logbook submenu (Event list submenu) and is not displayed in alternation with the operational display.
Off	The diagnostic event is ignored, and no diagnostic message is generated or entered.

12.3.2 Adapting the status signal

Each item of diagnostic information is assigned a specific status signal at the factory. The user can change this assignment for specific diagnostic information in the Diagnostic event category submenu.

Expert → Communication → Diagnostic event category

Available status signals

Configuration as per HART 7 Specification (Condensed Status), in accordance with NAMUR NE107.

Symbol	Meaning
F <small>A0013956</small>	Failure A device error is present. The measured value is no longer valid.
C <small>A0013959</small>	Function check The device is in service mode (e.g. during a simulation).
S <small>A0013958</small>	Out of specification The device is being operated: <ul style="list-style-type: none"> • Outside its technical specification limits (e.g. outside the process temperature range) • Outside of the configuration carried out by the user (e.g. maximum flow in parameter 20 mA value)
M <small>A0013957</small>	Maintenance required Maintenance is required. The measured value is still valid.
N <small>A0023076</small>	Has no effect on the condensed status.

12.4 Overview of diagnostic information

 The amount of diagnostic information and the number of measured variables affected increase if the measuring device has one or more application packages.

 In the case of some items of diagnostic information, the status signal and the diagnostic behavior can be changed. Change the diagnostic information → See 12.3.1

Diagnostic number	Short text	Remedy instructions	Status signal [from the factory]	Diagnostic behavior [from the factory]
Diagnostic of sensor				
004	Sensor defective	1. Check plug connections 2. Change pre-amplifier 3. Change DSC sensor	F	Alarm
022	Temperature sensor defective	1. Check plug connections 2. Change pre-amplifier 3. Change DSC sensor	F	Alarm ¹⁾
046	Sensor limit exceeded	1. Check plug connections 2. Change pre-amplifier 3. Change DSC sensor	S	Warning

Diagnostic number	Short text	Remedy instructions	Status signal [from the factory]	Diagnostic behavior [from the factory]
062	Sensor connection defective	1. Check plug connections 2. Change pre-amplifier 3. Change DSC sensor	F	Alarm
082	Data storage	1. Check module connections 2. Contact service	F	Alarm
083	Memory content	1. Restart device 2. Restore S-Dat data 3. Change sensor	F	Alarm
114	Sensor leaky	Change DSC sensor	F	Alarm
122	Temperature sensor defective	1. Check plug connections 2. Change pre-amplifier 3. Change DSC sensor	M	Warning ¹⁾
170	Pressure cell connection defective	1. Check plug connections 2. Replace pressure cell	F	Alarm
171	Ambient temperature too low	Increase ambient temperature	S	Warning
172	Ambient temperature too high	Reduce ambient temperature	S	Warning
173	Sensor range exceeded	1. Check process cond. 2. Increase system pressure	S	Warning
174	Pressure cell electronics defective	Replace pressure cell	F	Alarm
175	Pressure cell deactivated	Enable pressure cell	M	Warning
Diagnostic of electronic				
242	Software incompatible	1. Check software 2. Flash or change main electronics module	F	Alarm
252	Modules incompatible	1. Check if correct electronic modul is plugged 2. Replace electronic module	F	Alarm
261	Electronic modules	1. Restart device 2. Check electronic modules 3. Change I/O Modul or main electronics	F	Alarm
262	Module connection	1. Check module connections 2. Change electronic modules	F	Alarm
270	Main electronic failure	Change main electronic module	F	Alarm
271	Main electronic failure	1. Restart device 2. Change main electronic module	F	Alarm
272	Main electronic failure	1. Restart device 2. Contact service	F	Alarm
272	ECC settings faulty		F	Alarm
273	Main electronic failure	1. Emergency operation via display 2. Change main electronics	F	Alarm
275	I/O module defective	Change I/O module	F	Alarm
276	I/O module faulty	1. Restart device 2. Change I/O module	F	Alarm
276	I/O module faulty		F	Alarm
277	Electronics defective	1. Change pre-amplifier 2. Change main electronic module	F	Alarm
282	Data storage	1. Restart device 2. Contact service	F	Alarm

Diagnostic number	Short text	Remedy instructions	Status signal [from the factory]	Diagnostic behavior [from the factory]
283	Memory content	1. Transfer data or reset device 2. Contact service	F	Alarm
302	Device verification active	Device verification active, please wait.	C	Warning
311	Electronic failure	Maintenance required! 1. Do not perform reset 2. Contact service	M	Warning
350	Pre-amplifier defective	Change pre-amplifier	F	Alarm ¹⁾
351	Pre-amplifier defective	Change pre-amplifier	F	Alarm
370	Pre-amplifier defective	1. Check plug connections 2. Check cabel connection of remote version 3. Change pre-amplifier or main electronic module	F	Alarm
371	Temperature sensor defective	1. Check plug connections 2. Change pre-amplifier 3. Change DSC sensor	M	Warning ¹⁾
Diagnostic of configuration				
410	Data transfer	1. Check connection 2. Retry data transfer	F	Alarm
412	Processing download	Download active, please wait	C	Warning
431	Trim 1 to n	Carry out trim	C	Warning
437	Configuration incompatible	1. Restart device 2. Contact service	F	Alarm
438	Dataset	1. Check data set file 2. Check device configuration 3. Up- and download new configuration	M	Warning
441	Current output 1 to n	1. Check process 2. Check current output settings	S	Warning ¹⁾
442	Frequency output	1. Check process 2. Check frequency output settings	S	Warning ¹⁾
443	Pulse output	1. Check process 2. Check pulse output settings	S	Warning ¹⁾
444	Current input 1	1. Check process 2. Check current input settings	S	Warning ¹⁾
453	Flow override	Deactivate flow override	C	Warning
484	Failure mode simulation	Deactivate simulation	C	Alarm
485	Measured variable simulation	Deactivate simulation	C	Warning
486	Current input 1 simulation	Deactivate simulation	C	Warning
491	Current output 1 to n simulation	Deactivate simulation	C	Warning
492	Simulation frequency output	Deactivate simulation frequency output	C	Warning
493	Simulation pulse output	Deactivate simulation pulse output	C	Warning
494	Switch output simulation	Deactivate simulation switch output	C	Warning

Diagnostic number	Short text	Remedy instructions	Status signal [from the factory]	Diagnostic behavior [from the factory]
495	Diagnostic event simulation	Deactivate simulation	C	Warning
538	Flow computer configuration incorrect	Check input value (pressure, temperature)	S	Warning
539	Flow computer configuration incorrect	1. Check input value (pressure, temperature) 2. Check allowed values of the medium properties	S	Alarm
540	Flow computer configuration incorrect	Check entered reference value using the document Operating Instructions	S	Warning
570	Inverted delta heat	Check configuration of mounting location (parameter Installation direction)	F	Alarm
Diagnostic of process				
801	Supply voltage too low	Increase supply voltage	F	Alarm ¹⁾
803	Current loop	1. Check wiring 2. Change I/O module	F	Alarm
828	Ambient temperature too low	Increase ambient temperature of pre-amplifier	S	Warning ¹⁾
829	Ambient temperature too high	Reduce ambient temperature of pre-amplifier	S	Warning ¹⁾
832	Electronic temperature too high	Reduce ambient temperature	S	Warning ¹⁾
833	Electronic temperature too low	Increase ambient temperature	S	Warning ¹⁾
834	Process temperature too high	Reduce process temperature	S	Warning ¹⁾
835	Process temperature too low	Increase process temperature	S	Warning ¹⁾
841	Flow velocity too high	Reduce flow velocity	S	Warning ¹⁾
842	Process limit	Low flow cut off active! 1. Check low flow cut off configuration	S	Warning
844	Sensor range exceeded	Reduce flow velocity	S	Warning ¹⁾
870	Measuring inaccuracy increased	1. Check process 2. Increase flow volume	S	Warning ¹⁾
871	Near steam saturation limit	Check process conditions	S	Warning ¹⁾
872	Wet steam detected	1. Check process 2. Check plant	S	Warning ¹⁾
873	Water detected	Check process (water in piping)	S	Warning ¹⁾
874	X% spec invalid	1. Check pressure, temperature 2. Check flow velocity 3. Check for flow fluctuation	S	Warning ¹⁾
882	Input signal	1. Check input configuration 2. Check external device or process conditions	F	Alarm
945	Sensor range exceeded	Check immediately process conditions (pressure-temperature rating)	S	Warning ¹⁾

Diagnostic number	Short text	Remedy instructions	Status signal [from the factory]	Diagnostic behavior [from the factory]
946	Vibration detected	Check installation	S	Warning
947	Vibration exceeded	Check installation	S	Alarm ¹⁾
948	Signal quality bad	1. Check process conditions: wet gas, pulsation 2. Check installation: vibration	S	Warning
972	Degrees of superheat limit exceeded	1. Controll process conditions 2. Install pressure transmitter or enter correct fixed pressure value	S	Warning ¹⁾

1) Diagnostic behavior can be changed.

12.4.1 Operating conditions for displaying the following diagnostics information

-  Operating conditions for displaying the following diagnostics information:
- 871 Near steam saturation limit diagnostic message: The process temperature is less than 2K from the saturated steam line.
 - Diagnostics information 872: The measured steam quality has dropped below the configured limit value for the steam quality (limit value: Expert → System → Diagnostic handling → Diagnostic limits → Steam quality limit).
 - Diagnostics information 873: The process temperature is $\leq 0^{\circ}\text{C}$.
 - Diagnostics information 874: Wet steam detection/measurement is outside the specified limits for the following process parameters: pressure, temperature, velocity.
 - Pressure: 0.5 to 100 bar
 - Temperature: $+81.3$ to $+320^{\circ}\text{C}$ ($+178.3$ to $+608^{\circ}\text{F}$)
 - Velocity: Depends on the measuring tube and is configured via EhDS.
 - Diagnostics information 972: The degree of superheat has exceeded the configured limit value (limit value: Expert → System → Diagnostic handling → Diagnostic limits → Degrees of superheat limit).

12.4.2 Emergency mode in the event of pressure compensation

- ▶ Disable the pressure measuring cell: in the Disable pressure cell parameter (7747) select the Yes option.
 - ↳ The measuring device uses the fixed process pressure to calculate.

12.4.3 Emergency mode in event of temperature compensation

- ▶ Change temperature measurement: PT1+PT2 to the PT1 option, PT2 option or the Off option.
 - ↳ If the Off option is selected, the measuring device calculates by using the fixed process pressure.

12.5 Pending diagnostic events

The Diagnostics menu allows the user to view the current diagnostic event and the previous diagnostic event separately.

 To call up the measures to rectify a diagnostic event:

- Via local display → See 12.2.2

 Other pending diagnostic events can be displayed in the Diagnostic list submenu → See 12.6

Navigation

"Diagnostics" menu

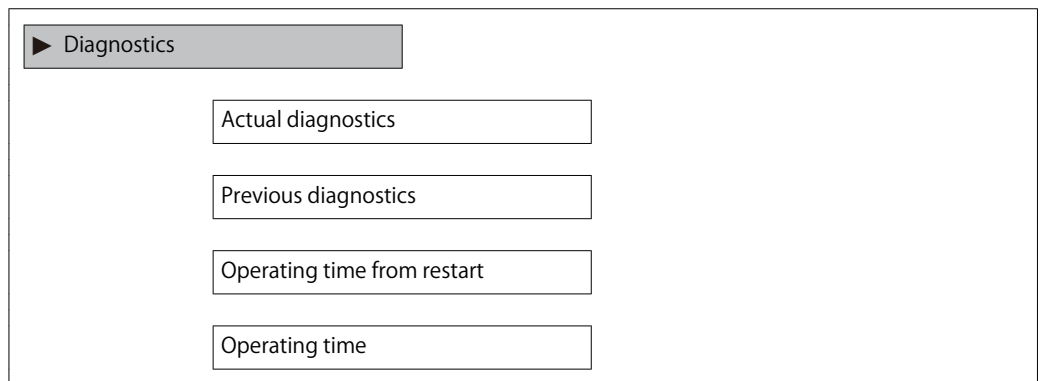

Parameter overview with brief description

Parameter	Prerequisite	Description	User interface
Actual diagnostics	A diagnostic event has occurred.	Shows the current occurred diagnostic event along with its diagnostic information.  If two or more messages occur simultaneously, the message with the highest priority is shown on the display.	Symbol for diagnostic behavior, diagnostic code and short message.
Previous diagnostics	Two diagnostic events have already occurred.	Shows the diagnostic event that occurred prior to the current diagnostic event along with its diagnostic information.	Symbol for diagnostic behavior, diagnostic code and short message.
Operating time from restart	–	Shows the time the device has been in operation since the last device restart.	Days (d), hours (h), minutes (m) and seconds (s)
Operating time	–	Indicates how long the device has been in operation.	Days (d), hours (h), minutes (m) and seconds (s)

12.6 Diagnostic list

Up to 5 currently pending diagnostic events can be displayed in the Diagnostic list submenu along with the associated diagnostic information. If more than 5 diagnostic events are pending, the events with the highest priority are shown on the display.

Navigation path

Diagnostics → Diagnostic list

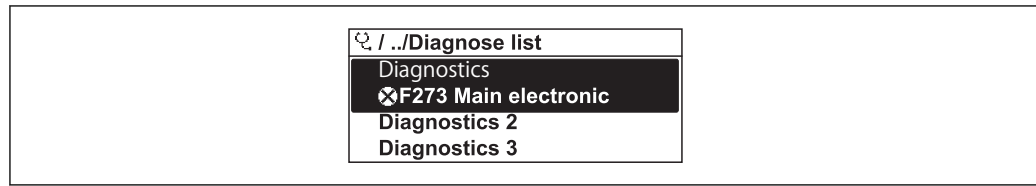

A0014006-EN

Taking the example of the local display

- To call up the measures to rectify a diagnostic event:
- Via local display → See 12.2.2

12.7 Event logbook

12.7.1 Reading out the event logbook

A chronological overview of the event messages that have occurred is provided in the Events list submenu.

Navigation path

Diagnostics menu → Event logbook submenu → Event list

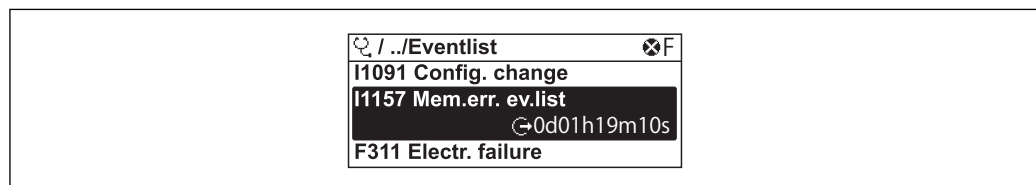

A0014008-EN

Taking the example of the local display

- A maximum of 20 event messages can be displayed in chronological order.
- If the Extended HistoROM application package (order option) is enabled in the device, the event list can contain up to 100 entries .

The event history includes entries for:

- Diagnostic events → See 12.3.2
- Information events → See 12.7.3

In addition to the operation time of its occurrence, each event is also assigned a symbol that indicates whether the event has occurred or is ended:

- Diagnostic event
 - → : Occurrence of the event
 - ⇨ : End of the event
- Information event
 - → : Occurrence of the event

- To call up the measures to rectify a diagnostic event:
- Via local display → See 12.2.2

For filtering the displayed event messages → See 12.7.2

12.7.2 Filtering the event logbook

Using the Filter options parameter you can define which category of event message is displayed in the Events list submenu.

Navigation path

Diagnostics → Event logbook → Filter options

Filter categories

- All
- Failure (F)
- Function check (C)
- Out of specification (S)
- Maintenance required (M)
- Information (I)

12.7.3 Overview of information events

Unlike a diagnostic event, an information event is displayed in the event logbook only and not in the diagnostic list.

Info number	Info name
I1000	------(Device ok)
I1079	Sensor changed
I1089	Power on
I1090	Configuration reset
I1091	Configuration changed
I1092	HistoROM backup deleted
I1110	Write protection switch changed
I1137	Electronic changed
I1151	History reset
I1154	Reset terminal voltage min/max
I1155	Reset electronic temperature
I1156	Memory error trend
I1157	Memory error event list
I1185	Display backup done
I1186	Restore via display done
I1187	Settings downloaded with display
I1188	Display data cleared
I1189	Backup compared
I1227	Sensor emergency mode activated
I1228	Sensor emergency mode failed
I1256	Display: access status changed
I1264	Safety sequence aborted
I1335	Firmware changed
I1397	Fieldbus: access status changed
I1398	CDI: access status changed
I1444	Device verification passed
I1445	Device verification failed
I1459	I/O module verification failed
I1461	Sensor verification failed
I1512	Download started
I1513	Download finished

Info number	Info name
I1514	Upload started
I1515	Upload finished
I1552	Failed: Main electronic verification
I1553	Failed: Pre-amplifier verification
I1554	Safety sequence started
I1555	Safety sequence confirmed
I1556	Safety mode off

12.8 Resetting the measuring device

Using the Device reset parameter (→ See 10.5.7) it is possible to reset the entire device configuration or some of the configuration to a defined state.

12.8.1 Function scope of the "Device reset" parameter

Options	Description
Cancel	No action is executed and the user exits the parameter.
To factory defaults	Every parameter is reset to its factory setting.
To delivery settings	Every parameter for which a customer-specific default setting was ordered is reset to this customer-specific value. All other parameters are reset to the factory setting.  This option is not visible if no customer-specific settings have been ordered.
Restart device	The restart resets every parameter whose data are in the volatile memory (RAM) to the factory setting (e.g. measured value data). The device configuration remains unchanged.

12.9 Device information

The Device information submenu contains all parameters that display different information for device identification.



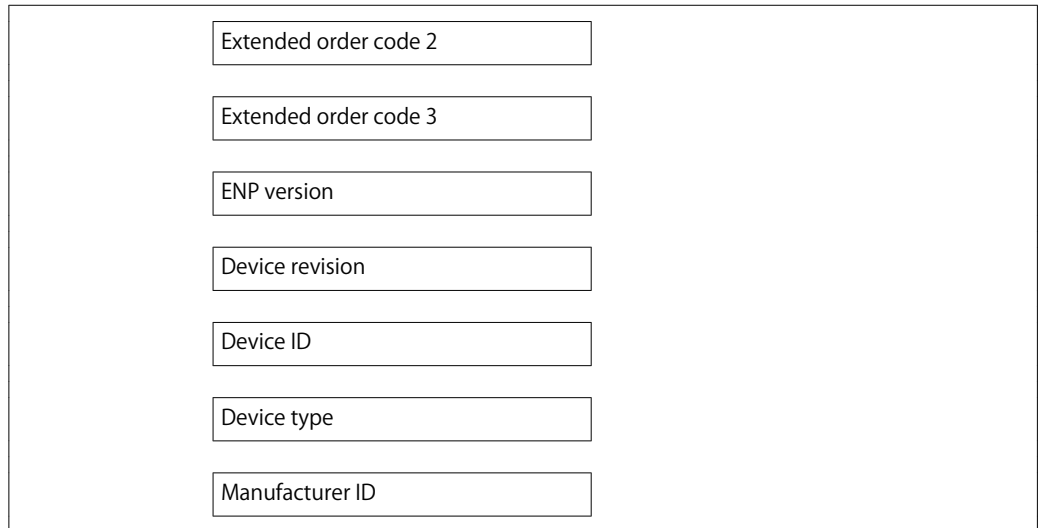

Navigation

"Diagnostics" menu → Device information

▶ Device information



Parameter overview with brief description

Parameter	Description	User interface	Factory setting
Device tag	Shows name of measuring point.	Max. 32 characters, such as letters, numbers or special characters (e.g. @, %, /).	EF200-C
Serial number	Shows the serial number of the measuring device.	Max. 11-digit character string comprising letters and numbers.	-
Firmware version	Shows the device firmware version installed.	Character string in the format xx.yy.zz	-
Device name	Shows the name of the transmitter.  The name can be found on the nameplate of the transmitter.	Max. 32 characters such as letters or numbers.	EF200-C
Order code	Shows the device order code.  The order code can be found on the nameplate of the sensor and transmitter in the "Order code" field.	Character string composed of letters, numbers and certain punctuation marks (e.g. /).	-
Extended order code 1	Shows the 1st part of the extended order code.  The extended order code can also be found on the nameplate of the sensor and transmitter in the "Ext. ord. cd." field.	Character string	-
Extended order code 2	Shows the 2nd part of the extended order code.  The extended order code can also be found on the nameplate of the sensor and transmitter in the "Ext. ord. cd." field.	Character string	-
Extended order code 3	Shows the 3rd part of the extended order code.  The extended order code can also be found on the nameplate of the sensor and transmitter in the "Ext. ord. cd." field.	Character string	-
ENP version	Shows the version of the electronic nameplate (ENP).	Character string	2.02.00

Parameter	Description	User interface	Factory setting
Device revision	Shows the device revision with which the device is registered with the HART Communication Foundation.	2-digit hexadecimal number	0x03
Device ID	Shows the device ID for identifying the device in a HART network.	6-digit hexadecimal number	–
Device type	Shows the device type with which the measuring device is registered with the HART Communication Foundation.	2-digit hexadecimal number	0x0038
Manufacturer ID	Shows the manufacturer ID device is registered with the HART Communication Foundation.	2-digit hexadecimal number	0x11

13 Maintenance

13.1 Maintenance tasks

No special maintenance work is required.

13.1.1 Exterior cleaning

When cleaning the exterior of measuring devices, always use cleaning agents that do not attack the surface of the housing or the seals.

13.1.2 Interior cleaning

NOTICE

The use of unsuitable equipment or cleaning liquids can damage the transducer.

- ▶ Do not use pigs to clean the pipe.

13.1.3 Replacing seals

Replacing sensor seals

NOTICE

Seals in contact with fluid must always be replaced!

- ▶ Only TLV sensor seals may be used: replacement seals

Replacing housing seals

NOTICE

When using the device in a dusty atmosphere:

- ▶ only use the associated TLV housing seals.

1. Replace defect seals only with original seals from TLV.
2. The housing seals must be clean and undamaged when inserted into their grooves.
3. Dry, clean or replace the seals if necessary.

13.1.4 Adjusting the pressure measuring cell

Navigation:

Expert → Sensor → Sensor adjustment

1. Apply reference pressure to pressure measuring cell.
2. Enter this reference pressure as a value in the Reference pressure parameter (7748).
3. Select an option in the Pressure cell adjustment parameter (7754):
 - ▶ Yes option: Confirm entry.
 - Cancel option: Cancel entry by entering "Cancel".
 - Discard offset option: Reset offset to 0.

The Pressure cell offset value parameter (7749) indicates the calculated offset value.

14 Repair

14.1 General notes

14.1.1 Repair and conversion concept

The repair and conversion concept provides for the following:

- The measuring devices have a modular design.
- Spare parts are grouped into logical kits with the associated Installation Instructions.
- Repairs are carried out by TLV Service or by appropriately trained customers.

14.1.2 Notes for repair and conversion

For repair and modification of a measuring device, observe the following notes:

- ▶ Use only original TLV spare parts.
- ▶ Carry out the repair according to the Installation Instructions.
- ▶ Observe the applicable standards, federal/national regulations, Ex documentation (XA) and certificates.

14.2 Spare parts

Some interchangeable measuring device components are listed on an overview sign in the connection compartment cover.

EF200R-C Spare parts

Item	Description	TLV No.
EF200 preamplifier kit		5-966891
EF200 I/O board (standard)		5-969029
EF200 I/O board (input)		5-969030
EF200 display		5-969031
EF200 connecting cable	For remote version	5-966878
EF200 pipe mounting kit	DK8WM-B	5-969122
EF200 pipe mounting kit		5-969121
EF200-C nameplate	NP-2100/compact version	5-968528
EF200-C nameplate	NP-2101/remote display	5-968529
EF200-C nameplate	NP-2102/remote sensor	5-968530
EF200-C main module		5-968502
EF200R-C DSC sensor set		5-968506
EF200R-C DSC sensor set	Device with pressure sensor	5-968507

14.3 Disposal



If required by the Directive 2012/19/EU on waste electrical and electronic equipment (WEEE), the product is marked with the depicted symbol in order to minimize the disposal of WEEE as unsorted municipal waste. Do not dispose of products bearing this marking as unsorted municipal waste. Instead, return them to TLV for disposal under the applicable conditions.

14.3.1 Removing the measuring device

1. Switch off the device.



Danger to persons from process conditions.

- ▶ Beware of hazardous process conditions such as pressure in the measuring device, high temperatures or aggressive fluids.
2. Carry out the mounting and connection steps from the "Mounting the measuring device" and "Connecting the measuring device" sections in reverse order. Observe the safety instructions.

14.3.2 Disposing of the measuring device



Danger to personnel and environment from fluids that are hazardous to health.

- ▶ Ensure that the measuring device and all cavities are free of fluid residues that are hazardous to health or the environment, e.g. substances that have permeated into crevices or diffused through plastic.

Observe the following notes during disposal:

- ▶ Observe valid federal/national regulations.
- ▶ Ensure proper separation and reuse of the device components.

15 Accessories

Various accessories, which can be ordered with the device or subsequently from TLV, are available for the device. Detailed information on the order code in question is available from your local Endress+Hauser sales center or on the product page of the

15.1 Device-specific accessories

15.1.1 For the transmitter

Accessories	Description
EF200R-C	Transmitter for replacement or storage. Use the order code to define the following specifications: <ul style="list-style-type: none"> • Approvals • Output, Input • Display/operation • Housing • Software
Overvoltage protection for 2-wire devices	Ideally, the overvoltage protection module should be ordered directly with the device.
Protective cover	Is used to protect the measuring device from the effects of the weather: e.g. rainwater, excess heating from direct sunlight or extreme cold in winter.
Connecting cable for remote version	<ul style="list-style-type: none"> • 30 m (98 ft)
Post mounting kit	Post mounting kit for transmitter.  The post mounting kit can only be ordered together with a transmitter.

15.1.2 For the sensor

Accessories	Description
Flow conditioner	Is used to shorten the necessary inlet run.

Item	Size (mm)	Specification	TLV Item No.
Flow conditioner	015	ASME150	5-960655
		ASME300	5-960656
		JIS10/20K	5-960643
	025	ASME150	5-960657
		ASME300	5-969032
		JIS10/20K	5-960644
	040	ASME150	5-960658
		ASME300	5-960659
		JIS10/20K	5-960645
	050	ASME150	5-969033
		ASME300	5-969034
		JIS10K	5-960646
		JIS20K	5-969015
	080	ASME150	5-960660
		ASME300	5-960661
		JIS10K	5-960647
		JIS20K	5-969018
	100	ASME150	5-960662
		ASME300	5-969035
		JIS10K	5-960648
		JIS20K	5-969019
	150	ASME150	5-969036
		ASME300	5-960663
		JIS10K	5-960649
		JIS20K	5-960650
	200	ASME150	5-960664
		ASME300	5-960665
		JIS10K	5-960651
JIS20K		5-968786	
250	ASME150	5-968788	
	ASME300	5-968787	
	JIS10K	5-960652	
	JIS20K	5-960653	
300	ASME150	5-968790	
	ASME300	5-960666	
	JIS10K	5-960654	
	JIS20K	5-968789	

16 Technical data

16.1 Application

The measuring device is intended only for the flow measurement of liquids with a minimum conductivity of 20 µS/cm.

To ensure that the device remains in proper operating condition for its service life, use the measuring device only for media against which the process-wetted materials are sufficiently resistant.

16.2 Function and system design

Measuring principle Vortex meters work on the principle of the Karman vortex street.

Measuring system The device consists of a transmitter and a sensor.
 Two device versions are available:
 • Compact version – transmitter and sensor form a mechanical unit.
 • Remote version - transmitter and sensor are mounted in separate locations.
 For information on the structure of the device → See 3.1

16.3 Input

Measured variable Direct measured variables

"Sensor version; DSC sensor; measuring tube"	
Description	Measured variable
Mass; 316L; 316L (integrated temperature measurement)	<ul style="list-style-type: none"> • Volume flow • Temperature

"Sensor version; DSC sensor; measuring tube"	
Description	Measured variable
Mass steam; 316L; 316L (integrated pressure/temperature measurement)	<ul style="list-style-type: none"> • Volume flow • Temperature • Pressure

Calculated measured variables

Description	Measured variable
Volume high-temperature; 316L; 316L	Under constant process conditions: <ul style="list-style-type: none"> • Mass flow ¹⁾ • Corrected volume flow The totalized values for: <ul style="list-style-type: none"> • Volume flow • Mass flow • Corrected volume flow

1) A fixed density must be entered for calculating the mass flow (Setup menu → Advanced setup submenu → External compensation submenu → Fixed density parameter).

Description	Measured variable
Mass; 316L; 316L (integrated temperature measurement)	<ul style="list-style-type: none"> • Corrected volume flow • Mass flow • Calculated saturated steam pressure • Energy flow • Heat flow difference • Specific volume • Degrees of superheat

Measuring range

The measuring range is dependent on the nominal diameter, the fluid and environmental influences.

 The following specified values are the largest possible flow measuring ranges (Q_{\min} to Q_{\max}) for each nominal diameter. Depending on the fluid properties and environmental influences, the measuring range may be subject to additional restrictions. Additional restrictions apply to both the lower range value and the upper range value.

Flow measuring ranges in SI units

DN [mm]	Liquids [m ³ /h]	Gas/steam [m ³ /h]
25R	0.1 to 4.9	0.52 to 25
40R	0.32 to 15	1.6 to 130
50R	0.78 to 37	3.9 to 310
80R	1.3 to 62	6.5 to 820
100R	2.9 to 140	15 to 1 800
150R	5.1 to 240	25 to 3 200
200R	11 to 540	57 to 7 300

Flow measuring ranges in US units

DN	Liquids	Gas/steam
[in]	[ft ³ /min]	[ft ³ /min]
1R	0.061 to 2.9	0.31 to 15
1½R	0.19 to 8.8	0.93 to 74
2R	0.46 to 22	2.3 to 180
3R	0.77 to 36	3.8 to 480
4R	1.7 to 81	8.6 to 1 100
6R	3 to 140	15 to 1 900
8R	6.8 to 320	34 to 4 300

Flow velocity

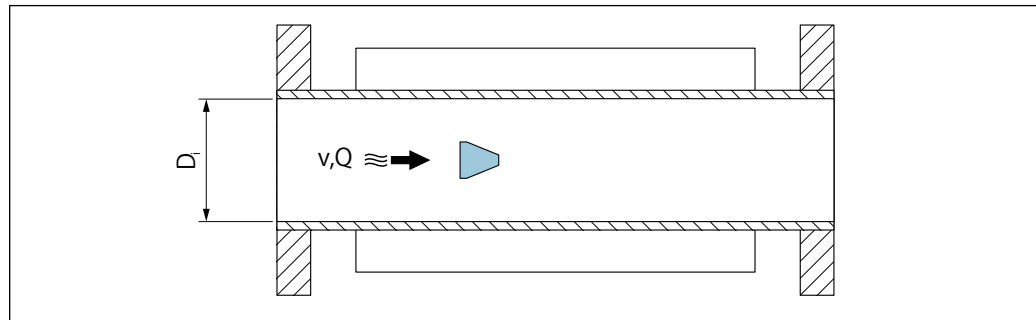

- D_i Internal diameter of measuring tube (corresponds to dimension K)
- v Velocity in measuring tube
- Q Flow

 The internal diameter of measuring tube, D_i is denoted in the dimensions as dimension K.

For detailed information, see the Technical Information.

Calculation of flow velocity:

$$v \text{ [m/s]} = \frac{4 \cdot Q \text{ [m}^3\text{/h]}}{\pi \cdot D_i \text{ [m]}^2} \cdot \frac{1}{3600 \text{ [s/h]}}$$

$$v \text{ [ft/s]} = \frac{4 \cdot Q \text{ [ft}^3\text{/min]}}{\pi \cdot D_i \text{ [ft]}^2} \cdot \frac{1}{60 \text{ [s/min]}}$$

A0034301

Lower range value

A restriction applies to the lower range value due to the turbulent flow profile, which only occurs with Reynolds numbers greater than 5000. The Reynolds number is dimensionless and indicates the ratio of the inertia force of a fluid to its viscous force when flowing and is used as a characteristic variable for pipe flows. In the case of pipe flows with Reynolds numbers less than 5000, periodic vortices are no longer generated and flow rate measurement is no longer possible.

The Reynolds number is calculated as follows:

$$\text{Re} = \frac{4 \cdot Q \text{ [m}^3/\text{s]} \cdot \rho \text{ [kg/m}^3\text{]}}{\pi \cdot D_i \text{ [m]} \cdot \mu \text{ [Pa} \cdot \text{s]}}$$

$$\text{Re} = \frac{4 \cdot Q \text{ [ft}^3/\text{s]} \cdot \rho \text{ [lbm/ft}^3\text{]}}{\pi \cdot D_i \text{ [ft]} \cdot \mu \text{ [lbf} \cdot \text{s/ft}^2\text{]}}$$

A0034291

Re	Reynolds number
Q	Flow
D_i	Internal diameter of measuring tube (corresponds to dimension K)
μ	Dynamic viscosity
ρ	Density

The Reynolds number, 5000 together with the density and viscosity of the fluid and the nominal diameter, is used to calculate the corresponding flow rate.

$$Q_{\text{Re} = 5000} \text{ [m}^3/\text{h]} = \frac{5000 \cdot \pi \cdot D_i \text{ [m]} \cdot \mu \text{ [Pa} \cdot \text{s]}}{4 \cdot \rho \text{ [kg/m}^3\text{]}} \cdot 3600 \text{ [s/h]}$$

$$Q_{\text{Re} = 5000} \text{ [ft}^3/\text{h]} = \frac{5000 \cdot \pi \cdot D_i \text{ [ft]} \cdot \mu \text{ [lbf} \cdot \text{s/ft}^2\text{]}}{4 \cdot \rho \text{ [lbm/ft}^3\text{]}} \cdot 60 \text{ [s/min]}$$

A0034302

$Q_{\text{Re} = 5000}$	Flow rate is dependent on the Reynolds number
D_i	Internal diameter of measuring tube (corresponds to dimension K)
μ	Dynamic viscosity
ρ	Density

The measuring signal must have a certain minimum signal amplitude so that the signals can be evaluated without any errors. Using the nominal diameter, the corresponding flow can also be derived from this amplitude. The minimum signal amplitude depends on the setting for the sensitivity of the DSC sensor (s), the steam quality (x) and the force of the vibrations present (a). The value mf corresponds to the lowest measurable flow velocity without vibration (no wet steam) at a density of 1 kg/m³ (0.0624 lbm/ft³). The value mf can be set in the range from 6 to 20 m/s (1.8 to 6 ft/s) (factory setting 12 m/s (3.7 ft/s)) with the Sensitivity parameter (value range 1 to 9, factory setting 5).

The lowest flow velocity that can be measured on account of the signal amplitude v_{AmpMin} is derived from the Sensitivity parameter and the steam quality (x) or from the force of vibrations present (a).

$$v_{\text{AmpMin}} \text{ [m/s]} = \max \left\{ \frac{mf \text{ [m/s]}}{x^2} \cdot \sqrt{\frac{1 \text{ [kg/m}^3\text{]}}{\rho \text{ [kg/m}^3\text{]}}} \right.$$

$$v_{\text{AmpMin}} \text{ [ft/s]} = \max \left\{ \frac{mf \text{ [ft/s]}}{x^2} \cdot \sqrt{\frac{0.062 \text{ [lb/ft}^3\text{]}}{\rho \text{ [lb/ft}^3\text{]}}} \right.$$

A0034303

- v_{AmpMin} Minimum measurable flow velocity based on signal amplitude
- mf Sensitivity
- x Steam quality
- ρ Density

$$Q_{\text{AmpMin}} \text{ [m}^3\text{/h]} = \frac{v_{\text{AmpMin}} \text{ [m/s]} \cdot \pi \cdot D_i \text{ [m]}^2}{4 \cdot \sqrt{\frac{\rho \text{ [kg/m}^3\text{]}}{1 \text{ [kg/m}^3\text{]}}}} \cdot 3600 \text{ [s/h]}$$

$$Q_{\text{AmpMin}} \text{ [ft}^3\text{/min]} = \frac{v_{\text{AmpMin}} \text{ [ft/s]} \cdot \pi \cdot D_i \text{ [ft]}^2}{4 \cdot \sqrt{\frac{\rho \text{ [lbm/ft}^3\text{]}}{0.0624 \text{ [lbm/ft}^3\text{]}}}} \cdot 60 \text{ [s/min]}$$

A0034304

- Q_{AmpMin} Minimum measurable flow rate based on signal amplitude
- v_{AmpMin} Minimum measurable flow velocity based on signal amplitude
- D_i Internal diameter of measuring tube (corresponds to dimension K)
- ρ Density

The effective lower range value Q_{Low} is determined using the largest of the three values Q_{min} , $Q_{\text{Re} = 5000}$ and Q_{AmpMin} .

$$Q_{\text{Low}} \text{ [m}^3\text{/h]} = \max \left\{ \begin{array}{l} Q_{\text{min}} \text{ [m}^3\text{/h]} \\ Q_{\text{Re} = 5000} \text{ [m}^3\text{/h]} \\ Q_{\text{AmpMin}} \text{ [m}^3\text{/h]} \end{array} \right.$$

$$Q_{\text{Low}} \text{ [ft}^3\text{/min]} = \max \left\{ \begin{array}{l} Q_{\text{min}} \text{ [ft}^3\text{/min]} \\ Q_{\text{Re} = 5000} \text{ [ft}^3\text{/min]} \\ Q_{\text{AmpMin}} \text{ [ft}^3\text{/min]} \end{array} \right.$$

A0034313

- Q_{Low} Effective lower range value
- Q_{min} Minimum measurable flow rate
- $Q_{\text{Re} = 5000}$ Flow rate is dependent on the Reynolds number
- Q_{AmpMin} Minimum measurable flow rate based on signal amplitude

Upper range value

The measuring signal amplitude must be below a certain limit value to ensure that the signals can be evaluated without error. This results in a maximum permitted flow rate Q_{AmpMax} :

$$Q_{\text{AmpMax}} [\text{m}^3/\text{h}] = \frac{350 [\text{m/s}] \cdot \pi D_i [\text{m}]^2}{4 \cdot \sqrt{\frac{\rho [\text{kg/m}^3]}{1 [\text{kg/m}^3]}}} \cdot 3600 [\text{s/h}]$$

$$Q_{\text{AmpMax}} [\text{ft}^3/\text{min}] = \frac{1148 [\text{ft/s}] \cdot \pi D_i [\text{ft}]^2}{4 \cdot \sqrt{\frac{\rho [\text{lbm/ft}^3]}{0.0624 [\text{lbm/ft}^3]}}} \cdot 60 [\text{s/min}]$$

A0034316

- Q_{AmpMax} Maximum measurable flow rate based on signal amplitude
 D_i Internal diameter of measuring tube (corresponds to dimension K)
 ρ Density

For gas applications, an additional restriction applies to the upper range value with regard to the Mach number in the measuring device, which must be less than 0.3. The Mach number Ma describes the ratio of the flow velocity v to the sound velocity c in the fluid.

$$Ma = \frac{v [\text{m/s}]}{c [\text{m/s}]}$$

$$Ma = \frac{v [\text{ft/s}]}{c [\text{ft/s}]}$$

A0034321

- Ma Mach number
 v Flow velocity
 c Sound velocity

The corresponding flow rate can be derived using the nominal diameter.

$$Q_{Ma=0.3} [\text{m}^3/\text{h}] = \frac{0.3 \cdot c [\text{m/s}] \cdot \pi D_i [\text{m}]^2}{4} \cdot 3600 [\text{s/h}]$$

$$Q_{Ma=0.3} [\text{ft}^3/\text{min}] = \frac{0.3 \cdot c [\text{ft/s}] \cdot \pi D_i [\text{ft}]^2}{4} \cdot 60 [\text{s/min}]$$

A0034337

- $Q_{Ma=0.3}$ Restricted upper range value is dependent on Mach number
 c Sound velocity
 D_i Internal diameter of measuring tube (corresponds to dimension K)
 ρ Density

The effective upper range value Q_{High} is determined using the smallest of the three values Q_{max} , Q_{AmpMax} and $Q_{\text{Ma}=0.3}$.

$$Q_{\text{High}} [\text{m}^3/\text{h}] = \min \begin{cases} Q_{\text{max}} [\text{m}^3/\text{h}] \\ Q_{\text{AmpMax}} [\text{m}^3/\text{h}] \\ Q_{\text{Ma}=0.3} [\text{m}^3/\text{h}] \end{cases}$$

$$Q_{\text{High}} [\text{ft}^3/\text{min}] = \min \begin{cases} Q_{\text{max}} [\text{ft}^3/\text{min}] \\ Q_{\text{AmpMax}} [\text{ft}^3/\text{min}] \\ Q_{\text{Ma}=0.3} [\text{ft}^3/\text{min}] \end{cases}$$

A0034338

- Q_{High} Effective upper range value
- Q_{max} Maximum measurable flow rate
- Q_{AmpMax} Maximum measurable flow rate based on signal amplitude
- $Q_{\text{Ma}=0.3}$ Restricted upper range value is dependent on Mach number

For liquids, the occurrence of cavitation may also restrict the upper range value.

Operable flow range

The value, which is typically up to 49: 1, may vary depending on the operating conditions (ratio between upper range value and lower range value)

16.4 Output

Output signal

Current output

Current output 1	4-20 mA (passive)
Resolution	< 1 μ A
Damping	Adjustable: 0.0 to 999.9 s
Assignable measured variables	<ul style="list-style-type: none"> • Volume flow • Corrected volume flow • Mass flow • Flow velocity • Temperature • Pressure • Calculated saturated steam pressure • Total mass flow • Energy flow • Heat flow difference

Pulse/frequency/switch output

Function	Can be set to pulse, frequency or switch output
Version	Passive, open collector
Maximum input values	<ul style="list-style-type: none"> • DC 35 V • 50 mA
Voltage drop	<ul style="list-style-type: none"> • For ≤ 2 mA: 2 V • For 10 mA: 8 V
Residual current	≤ 0.05 mA
Pulse output	
Pulse width	Adjustable: 5 to 2000 ms
Maximum pulse rate	100 Impulse/s
Pulse value	Adjustable
Assignable measured variables	<ul style="list-style-type: none"> • Mass flow • Volume flow • Corrected volume flow • Total mass flow • Energy flow • Heat flow difference
Frequency output	
Output frequency	Adjustable: 0 to 1000 Hz
Damping	Adjustable: 0 to 999 s
Pulse/pause ratio	1:1
Assignable measured variables	<ul style="list-style-type: none"> • Volume flow • Corrected volume flow • Mass flow • Flow velocity • Temperature • Calculated saturated steam pressure • Total mass flow • Energy flow • Heat flow difference • Pressure
Switch output	
Switching behavior	Binary, conductive or non-conductive
Switching delay	Adjustable: 0 to 100 s

Number of switching cycles	Unlimited
Assignable functions	<ul style="list-style-type: none"> • Off • On • Diagnostic behavior • Limit value <ul style="list-style-type: none"> • Volume flow • Corrected volume flow • Mass flow • Flow velocity • Temperature • Calculated saturated steam pressure • Total mass flow • Energy flow • Heat flow difference • Pressure • Reynolds number • Totalizer 1-3 • Status • Status of low flow cut off

Signal on alarm

Depending on the interface, failure information is displayed as follows:

Current output 4 to 20 mA

4 to 20 mA

Failure mode	Choose from: <ul style="list-style-type: none"> • 4 to 20 mA in accordance with NAMUR recommendation NE 43 • 4 to 20 mA in accordance with US • Min. value: 3.59 mA • Max. value: 22.5 mA • Freely definable value between: 3.59 to 22.5 mA • Actual value • Last valid value
--------------	--

Pulse/frequency/switch output

Pulse output	
Failure mode	No pulses
Frequency output	
Failure mode	Choose from: <ul style="list-style-type: none"> • Actual value • 0 Hz • Defined value: 0 to 1250 Hz
Switch output	
Failure mode	Choose from: <ul style="list-style-type: none"> • Current status • Open • Closed

Local display

Plain text display	With information on cause and remedial measures
--------------------	---

 Status signal as per NAMUR recommendation NE 107

Interface/protocol

- Via digital communication:
HART protocol
- Via service interface
CDI service interface

Plain text display	With information on cause and remedial measures
--------------------	---

Load → See 7.1.4

Low flow cut off The switch points for low flow cut off are preset and can be configured.

Galvanic isolation All inputs and outputs are galvanically isolated from one another.

Protocol-specific data

Manufacturer ID	0x11
Device type ID	0x0038
HART protocol revision	7
Device description files (DTM, DD)	Consult TLV for information.
HART load	<ul style="list-style-type: none"> • Min. 250 Ω • Max. 500 Ω
System integration	For information on system integration, see → See 10.4.3 <ul style="list-style-type: none"> • Measured variables via HART protocol • Burst Mode functionality

16.5 Power supply

Terminal assignment → See 7.1.4

Supply voltage Transmitter
An external power supply is required for each output.
The following supply voltage values apply for the outputs available:

Supply voltage for a compact version without a local display ¹⁾

"Output; input"	Minimum terminal voltage ²⁾	Maximum terminal voltage
4-20 mA HART, pulse/frequency/switch output	≥ DC 12 V	DC 35 V

- 1) In event of external supply voltage of the power supply unit with load
- 2) The minimum terminal voltage increases if local operation is used: see the following table
- 3) Voltage drop 2.2 to 3 V for 3.59 to 22 mA

Increase in minimum terminal voltage



Order code for "Display; operation"	Increase in minimum terminal voltage
Local operation	+ DC 1 V

Order code for "Sensor version; DSC sensor; measuring tube"	Increase in minimum terminal voltage
Mass steam; 316L; 316L (integrated pressure/temperature measurement)	+ DC 1 V

Power consumption

Transmitter

"Output; input"	Maximum power consumption
4-20 mA HART, pulse/frequency/switch output	<ul style="list-style-type: none"> • Operation with output 1: 770 mW • Operation with output 1 and 2: 2770 mW

Current consumption	<p>Current output</p> <p>For every 4-20 mA or 4-20 mA current output: 3.6 to 22.5 mA</p> <p> If the option Defined value is selected in the Failure mode parameter : 3.59 to 22.5 mA</p> <p>Current input</p> <p>3.59 to 22.5 mA</p> <p> Internal current limiting: max. 26 mA</p>
Power supply failure	<ul style="list-style-type: none"> • Totalizers stop at the last value measured. • Depending on the device version, the configuration is retained in the device memory or in the pluggable data memory (HistoROM DAT). • Error messages (incl. total operated hours) are stored.
Electrical connection	→ See 7.2
Potential equalization	→ See 7.2.3
Terminals	<ul style="list-style-type: none"> • For device version without integrated overvoltage protection: plug-in spring terminals for wire cross-sections 0.5 to 2.5 mm² (20 to 14 AWG) • For device version with integrated overvoltage protection: screw terminals for wire cross-sections 0.2 to 2.5 mm² (24 to 14 AWG)
Cable entries	<ul style="list-style-type: none"> • Thread for cable entry: <ul style="list-style-type: none"> • G ½"
Cable specification	→ See 7.1.2
Overvoltage protection	The device can be ordered with integrated overvoltage protection for diverse approvals: Order code for "Accessory mounted", option "Overvoltage protection"

Input voltage range	Values correspond to supply voltage specifications → See 16.5 ¹⁾
Resistance per channel	2 • 0.5 Ω max.
DC sparkover voltage	400 to 700 V
Trip surge voltage	< 800 V
Capacitance at 1 MHz	< 1.5 pF
Nominal discharge current (8/20 μs)	10 kA
Temperature range	–40 to +85 °C (–40 to +185 °F)

1) The voltage is reduced by the amount of the internal resistance $I_{min} \cdot R_i$

 Depending on the temperature class, restrictions apply to the ambient temperature for device versions with overvoltage protection .

 For detailed information on the temperature tables, see the "Safety Instructions" for the device.

16.6 Performance characteristics

Reference operating conditions

- Error limits following ISO/DIN 11631
- +20 to +30°C (+68 to +86°F)
- 2 to 4 bar (29 to 58 psi)
- Calibration system traceable to national standards
- Calibration with the process connection corresponding to the particular standard

Maximum measured error Base accuracy
o.r. = of reading

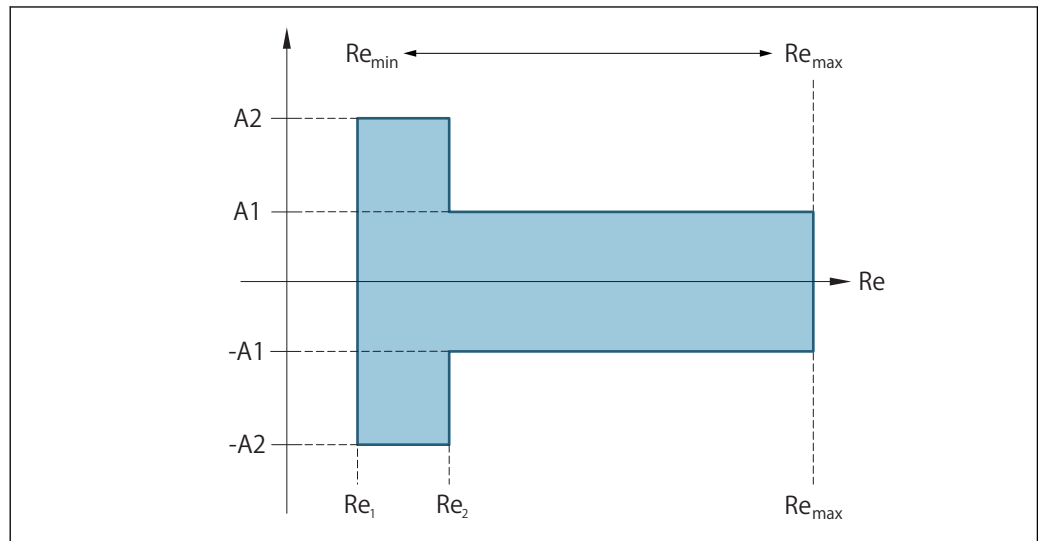

A0034077

Reynolds number	
Re ₁	5 000
Re ₂	10 000
Re _{min}	Reynolds number for minimum permitted volume flow in measuring tube
	• Standard

Reynolds number	
	$Q_{\text{AmpMin}} [\text{m}^3/\text{h}] = \frac{v_{\text{AmpMin}} [\text{m/s}] \cdot \pi \cdot D_i [\text{m}]^2}{4 \cdot \sqrt{\frac{\rho [\text{kg/m}^3]}{1 [\text{kg/m}^3]}}} \cdot 3600 [\text{s/h}]$ $Q_{\text{AmpMin}} [\text{ft}^3/\text{min}] = \frac{v_{\text{AmpMin}} [\text{ft/s}] \cdot \pi \cdot D_i [\text{ft}]^2}{4 \cdot \sqrt{\frac{\rho [\text{lbm/ft}^3]}{0.0624 [\text{lbm/ft}^3]}}} \cdot 60 [\text{s/min}]$ <p style="text-align: right;">A0034304</p>
Re _{max}	<p>Defined by internal diameter of measuring tube, Mach number and maximum permitted velocity in measuring tube</p> $Re_{\text{max}} = \frac{\rho \cdot 4 \cdot Q_{\text{Heigh}}}{\mu \cdot K}$ <p style="text-align: right;">A0034339</p> <p> Further information on effective upper range value Q_{High} → See 16.3</p>

Volume flow

Medium type		Incompressible	Compressible
Reynolds number range	Measured value deviation	Standard	Standard
Re ₂ to Re _{max}	A1	< 0.75 %	< 1.0 %
Re ₁ to Re ₂	A2	< 5.0 %	< 5.0 %

Temperature

- Saturated steam and liquids at room temperature, if T > 100 °C (212°F): < 1°C (1.8°F)
- Gas: < 1 % o.r. [K]
- Volume flow: 70 m/s (230 ft/s): 2 % o.r.
- Rise time 50 % (stirred under water, following IEC 60751): 8 s

Pressure

Order code for "Pressure component" ¹⁾	Nominal value [bar abs.]	Pressure ranges and measured errors	
		Pressure range [bar abs.]	Maximum measured error
Pressure measuring cell 40 bar_a	40	0.01 ≤ p ≤ 8 8 ≤ p ≤ 40	0.5 % of 8 bar abs. 0.5 % o.r.

1) The "mass" sensor version (integrated pressure/temperature measurement) is available only for measuring devices in HART communication mode.

Mass flow saturated steam

Sensor version				Mass (integrated temperature measurement)	Mass (integrated pressure/temperature measurement)
Process pressure [bar abs.]	Flow velocity [m/s (ft/s)]	Reynolds number range	Measured value deviation	Standard	Standard
> 4.76	20 to 50 (66 to 164)	Re ₂ to Re _{max}	A1	< 1.7 %	< 1.5 %
> 3.62	10 to 70 (33 to 230)	Re ₂ to Re _{max}	A1	< 2.0 %	< 1.8 %
In all cases not specified here, the following applies: < 5.7 %					

Mass flow of superheated steam/gases 3)

Sensor version				Mass (integrated pressure/temperature measurement) ¹⁾	Mass (integrated temperature measurement) + external pressure compensation ²⁾
Process pressure [bar abs.]	Flow velocity [m/s (ft/s)]	Reynolds number range	Measured value deviation	Standard	Standard
< 40	All velocities	Re ₂ to Re _{max}	A1	< 1.5 %	< 1.7 %
< 120		Re ₂ to Re _{max}	A1	< 2.4 %	< 2.6 %
In all cases not specified here, the following applies: < 6.6 %					

- 1) Sensor version available only for measuring devices in HART communication mode.
- 2) The use of a Cerabar S is required for the measured errors listed in the following section. The measured error used to calculate the error in the measured pressure is 0.15 %.

Water mass flow

Sensor version				Mass (integrated temperature measurement)
Process pressure [bar abs.]	Flow velocity [m/s (ft/s)]	Reynolds number range	Measured value deviation	Standard
All pressures	All velocities	Re ₂ to Re _{max}	A1	< 0.85 %
		Re ₁ to Re ₂	A2	< 2.7 %

3) single gas, gas mixture, air: NEL40; natural gas: ISO 12213-2 contains AGA8-DC92, AGA NX-19, ISO 12213-3 contains SGERG-88 and AGA8 Gross Method 1

Mass flow

Example

- Acetone is to be measured at fluid temperatures from +70 to +90 °C (+158 to +194°F).
- For this purpose, the Reference temperature parameter (7703) (here 80 °C (176 °F)), Reference density parameter (7700) (here 720.00 kg/m³) and Linear expansion coefficient parameter (7621) (here 18.0298 × 10⁻⁴1/°C) must be entered in the transmitter.
- The overall system uncertainty, which is less than 0.9 % for the example above, is comprised of the following measurement uncertainties: uncertainty of volume flow measurement, uncertainty of temperature measurement, uncertainty of the density-temperature correlation used (including the resulting uncertainty of density).

Mass flow (other media)

Depends on the selected fluid and the pressure value, which is specified in the parameters. Individual error analysis must be performed.

Accuracy of outputs

The outputs have the following base accuracy specifications.

Current output

Accuracy	±10 µA
----------	--------

Pulse/frequency output

o.r. = of reading

Accuracy	Max. ±100 ppm o.r.
----------	--------------------

Repeatability

o.r. = of reading

$$r = \left\{ \frac{100 \cdot D_1^3}{V} \right\}^{1/2} \% \text{ o.r.}$$

A0042121-EN

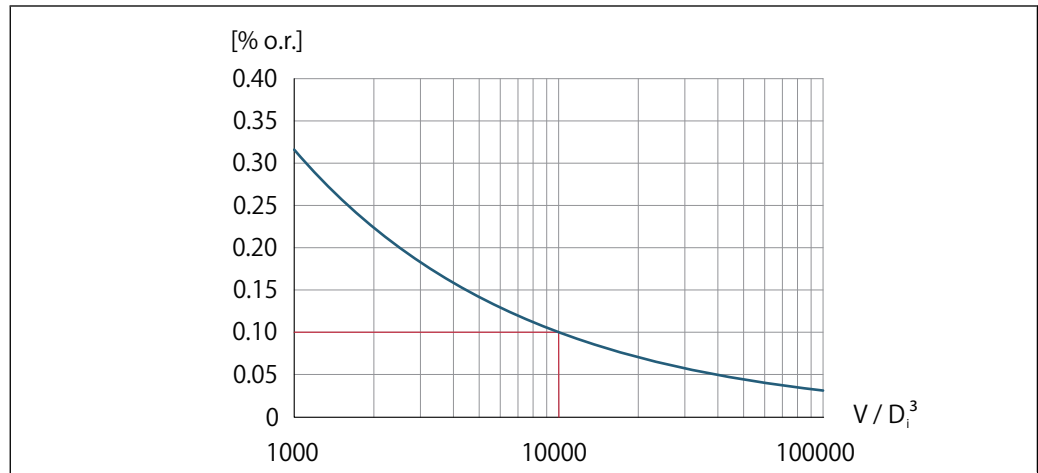

A0042123-EN

Repeatability = 0.1 % o.r. with a measured volume [m³] of $V = 10000 \cdot D_i^3$

The repeatability can be improved if the measured volume is increased. Repeatability is not a device characteristic but a statistical variable that is dependent on the boundary conditions indicated.

Response time

If all the configurable functions for filter times (flow damping, display damping, current output time constant, frequency output time constant, status output time constant) are set to 0, in the event of vortex frequencies of 10 Hz and higher a response time of $\max(T_v, 100 \text{ ms})$ can be expected.

In the event of measuring frequencies < 10 Hz, the response time is > 100 ms and can be up to 10 s. T_v is the average vortex period duration of the flowing fluid.

Influence of ambient temperature

Current output

o.r. = of reading

Additional error, in relation to the span of 16 mA:

Temperature coefficient at zero point (4 mA)	0.02 %/10 K
Temperature coefficient with span (20 mA)	0.05 %/10 K

Pulse/frequency output

o.r. = of reading

Temperature coefficient	Max. ± 100 ppm o.r.
-------------------------	-------------------------

16.7 Installation

Installation conditions

→ See 6.1.1

16.8 Environment

Ambient temperature range	<p>→ See 6.1.2</p> <p>–40 to +80 °C (–40 to +176 °F)</p>
Storage temperature	<p>All components apart from the display modules: –50 to +80 °C (–58 to +176 °F)</p> <p>Display modules</p> <p>All components apart from the display modules: –50 to +80 °C (–58 to +176 °F)</p> <p>Remote display FHX50: –50 to +80 °C (–58 to +176 °F)</p>
Climate class	DIN EN 60068-2-38 (test Z/AD)
Degree of protection	<p>Transmitter</p> <ul style="list-style-type: none"> • As standard: IP66/67, type 4X enclosure • When housing is open: IP20, type 1 enclosure • Display module: IP20, type 1 enclosure <p>Sensor</p> <p>IP66/67, type 4X enclosure</p>
Vibration resistance	<p>Vibration, sinusoidal according to IEC 60068-2-6</p> <ul style="list-style-type: none"> • 2 to 8.4 Hz, 7.5 mm peak • 8.4 to 500 Hz, 2 g peak • Order code for "Sensor version; DSC sensor; measuring tube", "mass steam; 316L; 316L (integrated pressure/temperature measurement)" • 2 to 8.4 Hz, 3.5 mm peak • 8.4 to 500 Hz, 1 g peak <p>Vibration broad-band random, according to IEC 60068-2-64</p> <ul style="list-style-type: none"> • 10 to 200 Hz, 0.01 g²/Hz • 200 to 500 Hz, 0.003 g²/Hz • Total 2.7 g rms • Order code for "Sensor version"; DSC sensor; measuring tube", "mass steam; 316L; 316L (integrated pressure/temperature measurement)" • 2 to 8.4 Hz, 3.5 mm peak • 8.4 to 500 Hz, 1 g peak

Shock resistance

Shock, half-sine according to IEC 60068-2-27
6 ms, 50 g

Shock resistance

Shock due to rough handling following IEC 60068-2-31

**Electromagnetic
compatibility (EMC)**

As per IEC/EN 61326 and NAMUR Recommendation 21 (NE 21)



Details are provided in the Declaration of Conformity.

16.9 Process

Medium temperature range DSC sensor¹⁾

Order code for "Sensor version; DSC sensor; measuring tube"	
Description	Medium temperature range
Volume; 316L; 316L	-40 to +260 °C (-40 to +500 °F), stainless steel
Mass; 316L; 316L	-200 to +400 °C (-328 to +752 °F), stainless steel

1) Capacitance sensor

Pressure measuring cell

Order code for "Pressure component"	
Description	Medium temperature range
Pressure measuring cell 40bar/580psi abs Pressure measuring cell 100bar/1450psi abs	-40 to +100 °C (-40 to +212 °F)

Seals

Order code for "DSC sensor seal"	
Description	Medium temperature range
Graphite (standard)	-200 to +400 °C (-328 to +752 °F)

Pressure-temperature ratings



An overview of the pressure-temperature ratings for the process connections is provided in the "Technical Information" document

Nominal pressure of sensor The following overpressure resistance values apply to the sensor shaft in the event of a membrane rupture:

Sensor version; DSC sensor; measuring tube	Overpressure, sensor shaft in [bar a]
Mass (integrated temperature measurement)	200
Mass steam (integrated pressure/temperature measurement) Mass gas/liquid (integrated pressure/temperature measurement)	200

Pressure specifications

-  For order code for "Sensor version; DSC sensor; measuring tube", option "Mass steam", the following applies:
 - Only available for measuring devices with the HART communication protocol
 - Oil-free or grease-free cleaning is not possible

The OPL (over pressure limit = sensor overload limit) for the measuring device depends on the lowest-rated element, with regard to pressure, of the selected components, i.e. the process connection has to be taken into consideration in addition to the measuring cell. Also observe pressure-temperature dependency. For the appropriate standards and further information → See 16.6. The OPL may only be applied for a limited period of time.

The MWP (maximum working pressure) for the sensors depends on the lowest-rated element, with regard to pressure, of the selected components, i.e. the process connection has to be taken into consideration in addition to the measuring cell. Also observe pressure-temperature dependency. For the appropriate standards and further information → See 16.6. The MWP may be applied at the device for an unlimited period. The MWP can also be found on the nameplate.

 **WARNING**

The maximum pressure for the measuring device depends on the lowest-rated element with regard to pressure.

- ▶ Note specifications regarding pressure range.
- ▶ The Pressure Equipment Directive (2014/68/EU) uses the abbreviation "PS". The abbreviation "PS" corresponds to the MWP of the device.
- ▶ MWP: The MWP is indicated on the nameplate. This value refers to a reference temperature of +20 °C (+68 °F) and may be applied to the device for an unlimited time. Note temperature dependence of MWP.
- ▶ OPL: The test pressure corresponds to the over pressure limit of the sensor and may be applied only temporarily to ensure that the measurement is within the specifications and no permanent damage occurs. In the case of sensor range and process connection combinations where the OPL of the process connection is less than the nominal value of the sensor, the device is set at the factory, at the very maximum, to the OPL value of the process connection. If using the entire sensor range, select a process connection with a higher OPL value.

Sensor	Maximum sensor measuring range		MWP	OPL
	Lower (LRL)	Upper (URL)		
	[bar (psi)]	[bar (psi)]	[bar (psi)]	[bar (psi)]
40 bar (600 psi)	0 (0)	+40 (+600)	100 (1 500)	160 (2 400)

16.10 Mechanical construction

Design, dimensions



For the dimensions and installation lengths of the device, see the "Technical Information" document, "Mechanical construction" section.

Weight

Compact version

Weight data:

- Including the transmitter:

1.8 kg (4.0 lb):

Weight in SI units

All values (weight) refer to devices with EN (DIN), PN 40 flanges. Weight information in [kg].

DN [mm]	Weight [kg] aluminum, coated, compact ¹⁾	
25R	15	6.1
40R	25	10.1
50R	40	12.1
80R	50	16.1
100R	80	23.1
150R	100	42.1
200R	150	63.1

Weight in US units

All values (weight) refer to devices with ASME B16.5, Class 300/Sch. 40 flanges. Weight information in [lbs].

DN [in]	Weight [lbs] aluminum, coated, compact ¹⁾	
1R	½	18.0
1½R	1	22.4
2R	1½	26.8
3R	2	48.8
4R	3	68.7
6R	4	121.6
8R	6	165.7

Transmitter remote version

Wall-mount housing

Dependent on the material of wall-mount housing:

"2.4 kg (5.2 lb):

Sensor remote version

Weight data:

- Including sensor connection housing:

0.8 kg (1.8 lb):

- Excluding the connecting cable
- Excluding packaging material

Weight in SI units

All values (weight) refer to devices with EN (DIN), PN 40 flanges. Weight information in [kg].

DN [mm]	Weight [kg] aluminum, coated, remote" 1)	
25R	15	5.1
40R	25	9.1
50R	40	11.1
80R	50	15.1
100R	80	21.1
150R	100	41.1
200R	150	62.1

Weight in US units

All values (weight) refer to devices with ASME B16.5, Class 300/Sch. 40 flanges. Weight information in [lbs].

DN [in]	Weight [lbs] aluminum, coated, remote" 1)	
1R	½	15.6
1½R	1	20.0
2R	1½	24.4
3R	2	46.4
4R	3	66.3
6R	4	119.2
8R	6	163.3

1) For high-temperature/low-temperature version: values + 0.4 lbs

Accessories

Flow conditioner

Weight in SI units

DN ¹⁾ [mm]	Pressure rating	Weight [kg]
15	PN 10 to 40	0.04
25	PN 10 to 40	0.1
40	PN 10 to 40	0.3
50	PN 10 to 40	0.5
80	PN 10 to 40	1.4
100	PN10 to 40	2.4
150	PN 10/16 PN 25/40	6.3 7.8
200	PN 10 PN 16/25 PN 40	11.5 12.3 15.9
250	PN 10 to 25 PN 40	25.7 27.5

1) EN (DIN)

DN ¹⁾ [mm]	Pressure rating	Weight [kg]
15	Class 150 Class 300	0.03 0.04
25	Class 150 Class 300	0.1
40	Class 150 Class 300	0.3
50	Class 150 Class 300	0.5
80	Class 150 Class 300	1.2 1.4
100	Class 150 Class 300	2.7
150	Class 150 Class 300	6.3 7.8
200	Class 150 Class 300	12.3 15.8
250	Class 150 Class 300	25.7 27.5

1) ASME

DN ¹⁾ [mm]	Pressure rating	Weight [kg]
15	20K	0.06
25	20K	0.1
40	20K	0.3
50	10K 20K	0.5
80	10K 20K	1.1
100	10K 20K	1.80
150	10K 20K	4.5 5.5
200	10K 20K	9.2
250	10K 20K	15.8 19.1

1) JIS

Weight in US units

DN ¹⁾ [in]	Pressure rating	Weight [lbs]
½	Class 150 Class 300	0.07 0.09
1	Class 150 Class 300	0.3
1½	Class 150 Class 300	0.7
2	Class 150 Class 300	1.1
3	Class 150 Class 300	2.6 3.1
4	Class 150 Class 300	6.0
6	Class 150 Class 300	14.0 16.0
8	Class 150 Class 300	27.0 35.0
10	Class 150 Class 300	57.0 61.0

1) ASME

Materials

Transmitter housing

Compact version

- Order code for "Housing", "GT20, two-chamber, aluminum, coated, compact":
Aluminum, AlSi10Mg, coated
- Window material: glass

Remote version

- Aluminum, AlSi10Mg, coated
- Window material: glass

Cable entries/cable glands

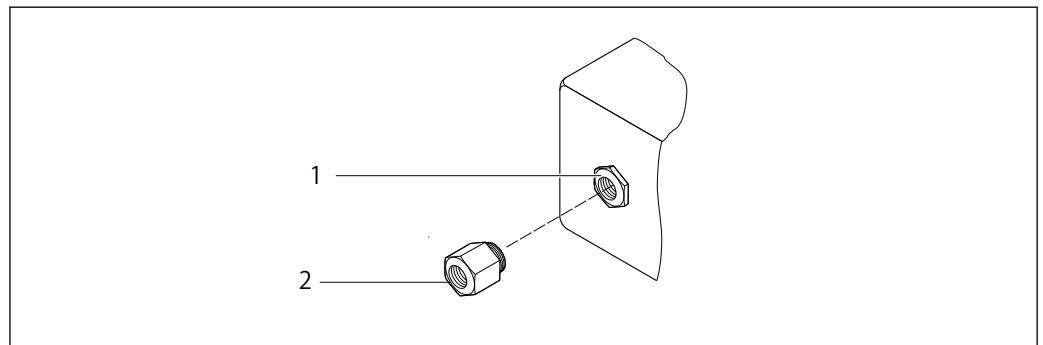

Possible cable entries/cable glands

- 1 Female thread M20 × 1.5
- 2 Adapter for cable entry with female thread G ½" or NPT ½"

Cable entry/cable gland	Type of protection	Material
Cable gland M20 × 1.5	Adapter for cable entry with female thread G ½"	Nickel-plated brass

Connecting cable for remote version

- Standard cable: PVC cable with copper shield

Sensor connection housing

The material of the sensor connection housing is dependent on the material selected for the transmitter housing.

- Coated aluminum AlSi10Mg

Measuring tubes

DN 25R to 200R (1R to 8R)/DN 40S to 250S (1½S to 10S"), Pressure ratings

PN 10/16/25/40, Class 150/300, as well as JIS 10K/20K:

Stainless cast steel, CF3M/1.4408

Compliant with:

- NACE MR0175
- NACE MR0103
- DN15 to 150 (½ to 6"): AD2000, permitted temperature range
–10 to +400 ° C (+14 to +752 ° F) restricted)

DSC sensor

Pressure ratings PN 10/16/25/40/63/100, Class 150/300/600, as well as JIS 10K/20K:

Parts in contact with medium (marked as "wet" on the DSC sensor flange):

- Stainless steel 1.4404 and 316 and 316L
- Compliant with:
 - NACE MR0175/ISO 15156-2015
 - NACE MR0103/ISO 17945-2015

Parts not in contact with medium:

Stainless steel 1.4301 (304)

- Wetted parts:
 - Process connection
Stainless steel, 1.4404/316L
 - Membrane
Stainless steel, 1.4435/316L
 - Non-wetted parts:
 - Housing
Stainless steel, 1.4404
- Order code for "Sensor version; DSC sensor; measuring tube"
- Siphon⁵⁾
Stainless steel, 1.4571
 - Adjusting nut
Stainless steel, 1.4571
 - Pressure gauge valve
Stainless steel, 1.4571
 - Welded connection on meter body
Stainless steel, multiple certifications 1.4404/316/316L
 - Seals
Copper

Process connections

DN 15 to 300 (½ to 12"), pressure ratings PN 10/16/25/40/63/100, Class 150/300, as well as JIS 10K/20K:

Welding neck flanges DN 15 to 300 (½ to 12")

Compliant with:

NACE MR0175-2003

NACE MR0103-2003

Seals

- Graphite (standard)
Sigraflex foi™ (BAM-tested for oxygen applications, "high-grade in the context of TA-Luft Clean Air Guidelines")

Housing support

Stainless steel, 1.4408 (CF3M)

Screws for DSC sensor

- Stainless steel, A2-80 according to ISO 3506-1 (304)

Accessories

Protective cover

Stainless steel, 1.4404 (316L)

Flow conditioner

- Stainless steel, multiple certifications, 1.4404 (316, 316L)
- Compliant with:
 - NACE MR0175-2003
 - NACE MR0103-2003

5) Only with order code for "Sensor version; DSC sensor; measuring tube", option available.

-
- Process connections** DN 15 to 300 (½ to 12"), pressure ratings PN 10/16/25/40/63/100, Class 150/300/600, as well as JIS 10K/20K:
- Welding neck flanges DN 15 to 300 (½ to 12")
- Compliant with:
- NACE MR0175-2003
NACE MR0103-2003
- The following materials are available depending on the pressure rating:
- Stainless steel, multiple certifications, 1.4404/F316/F316L)

 Available process connections

16.11 Operability

-
- Languages** Can be operated in the following languages:
- Via local display:
English, German, French, Spanish, Italian, Dutch, Portuguese, Polish, Russian, Swedish, Turkish, Chinese, Japanese, Korean, Bahasa (Indonesian), Vietnamese, Czech

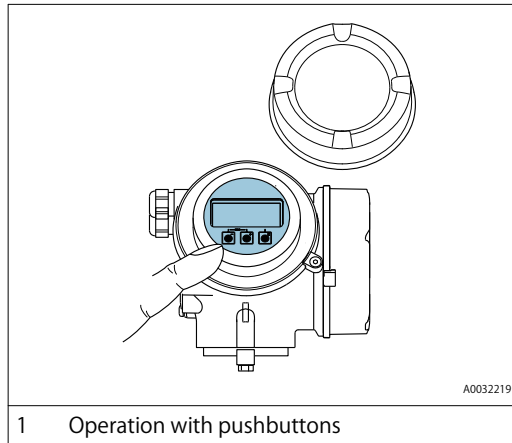

Local operation

Via display module

**Display elements**

- 4-line, illuminated, graphic display
- White background lighting; switches to red in event of device errors
- Format for displaying measured variables and status variables can be individually configured
- Permitted ambient temperature for the display: -20 to $+60$ ° C (-4 to $+140$ ° F)
The readability of the display may be impaired at temperatures outside the temperature range.

Operating elements

- Operation with 3 push buttons with open housing: , , 

Additional functionality

- Data backup function
The device configuration can be saved in the display module.
- Data comparison function
The device configuration saved in the display module can be compared to the current device configuration.
- Data transfer function
The transmitter configuration can be transmitted to another device using the display module.

16.12 Certificates and approvals

 Currently available certificates and approvals can be called up via the product configurator.

CE mark

The device meets the legal requirements of the applicable EU Directives. These are listed in the corresponding EU Declaration of Conformity along with the standards applied.

TLV confirms successful testing of the device by affixing to it the CE mark.

Pressure Equipment Directive

- With the identification PED/G1/x (x = category) on the sensor nameplate, TLV confirms conformity with the "Essential Safety Requirements" specified in Appendix I of the Pressure Equipment Directive 2014/68/EU.
- Devices not bearing this marking (PED) are designed and manufactured according to good engineering practice. They meet the requirements of Article 4 paragraph 3 of the Pressure Equipment Directive 2014/68/EU. The range of application is indicated in tables 6 to 9 in Annex II of the Pressure Equipment Directive 2014/68/EU.

Other standards and guidelines

- EN 60529
Degrees of protection provided by enclosures (IP code)
- DIN ISO 13359
Measurement of conductive liquid flow in closed conduits - Flanged-type electromagnetic flowmeters - Overall length
- EN 61010-1
Safety requirements for electrical equipment for measurement, control and laboratory use - general requirements
- IEC/EN 61326
Emission in accordance with Class A requirements. Electromagnetic compatibility (EMC requirements).
- NAMUR NE 21
Electromagnetic compatibility (EMC) of industrial process and laboratory control equipment
- NAMUR NE 32
Data retention in the event of a power failure in field and control instruments with microprocessors
- NAMUR NE 43
Standardization of the signal level for the breakdown information of digital transmitters with analog output signal.
- NAMUR NE 53
Software of field devices and signal-processing devices with digital electronics
- NAMUR NE 105
Specifications for integrating fieldbus devices in engineering tools for field devices
- NAMUR NE 107
Self-monitoring and diagnosis of field devices
- NAMUR NE 131
Requirements for field devices for standard applications

16.13 Application packages

Many different application packages are available to enhance the functionality of the device. Such packages might be needed to address safety aspects or specific application requirements.

 Detailed information on the application packages:
Special Documentation for the device

16.14 Accessories

 Overview of accessories available for order → See 15.1

16.15 Supplementary documentation

Standard documentation

Brief Operating Instructions for transmitter

Measuring device	Documentation code
EF200-C	172-5765m

Technical Information

Measuring device	Documentation code
EF200R-C	172-65758m

Description of Device Parameters

Measuring device	Documentation code
EF200-C	172-65764m

17 Flow Rate Data

Flow rate for saturated steam

Unit: kg/h

Size	25mm		40mm		50mm		80mm		100mm		150mm		200mm		Temp. (°C)
	Min.	Max.	Min.	Max.	Min.	Max.	Min.	Max.	Min.	Max.	Min.	Max.	Min.	Max.	
0.05	3.1	21	10	108	23	267	39	446	86	1001	149	1735	339	3947	111.6
0.1	3.5	27	11	142	27	349	44	583	99	1308	171	2266	388	5156	120.4
0.2	4.3	40	13	207	32	510	53	850	119	1909	206	3307	468	7523	133.7
0.3	4.9	53	15	271	37	667	61	1113	136	2498	236	4328	535	9847	143.7
0.4	5.4	65	17	334	41	823	68	1372	151	3080	262	5336	594	12140	151.9
0.5	5.9	78	18	397	44	977	74	1630	165	3657	285	6335	648	14413	158.9
0.6	6.3	90	20	459	48	1130	79	1885	177	4230	306	7327	696	16669	165.0
0.7	6.7	102	21	521	51	1282	84	2139	189	4800	326	8315	742	18915	170.5
0.8	7.1	114	22	583	54	1434	89	2392	199	5368	345	9298	784	21150	175.4
0.9	7.5	126	23	645	56	1585	94	2644	210	5934	363	10279	825	23382	179.9
1.0	7.8	138	24	706	59	1736	98	2896	219	6499	380	11257	863	25610	184.1
1.1	8.2	150	25	767	61	1887	102	3147	229	7063	396	12234	900	27832	188.0
1.2	8.5	163	26	829	64	2038	106	3398	238	7626	411	13211	935	30051	191.6
1.3	8.8	175	27	890	66	2188	110	3649	246	8190	426	14186	967	32270	195.1
1.4	9.1	187	28	951	68	2339	114	3900	255	8753	441	15162	1001	34490	198.3
1.5	9.4	199	29	1012	71	2489	117	4151	263	9316	454	16138	1033	36710	201.4
1.6	9.7	211	30	1074	73	2640	121	4403	270	9880	468	17114	1064	38935	204.3
1.7	9.9	223	31	1135	75	2791	124	4654	278	10444	481	18091	1094	41150	207.1
1.8	11	235	31	1196	77	2942	127	4906	285	11009	494	19069	1123	43380	209.8
1.9	11	247	32	1258	79	3093	131	5158	293	11574	506	20049	1152	45601	212.4
2.0	11	259	33	1319	80	3244	134	5410	300	12140	519	21030	1179	47837	214.9
2.5	12	320	36	1629	89	4005	148	6678	332	14986	576	25960	1310	59052	226.1
3.0	13	382	39	1942	97	4774	162	7961	363	17864	629	30945	1430	70390	235.7

Flow rate for air and water

Unit: m³/h

Fluid	Air (0°C Atmospheric press.)		Water (200°C)	
	Min.	Max.	Min.	Max.
Size (mm)				
25A	2.9	25	0.20	4.9
40A	8.8	125	0.35	15
50A	22	308	0.78	37
80A	36	513	1.30	62
100A	81	1,151	2.92	138
150A	140	1,995	5.05	239
200A	319	4,538	11.49	545

18 Function Matrix Details

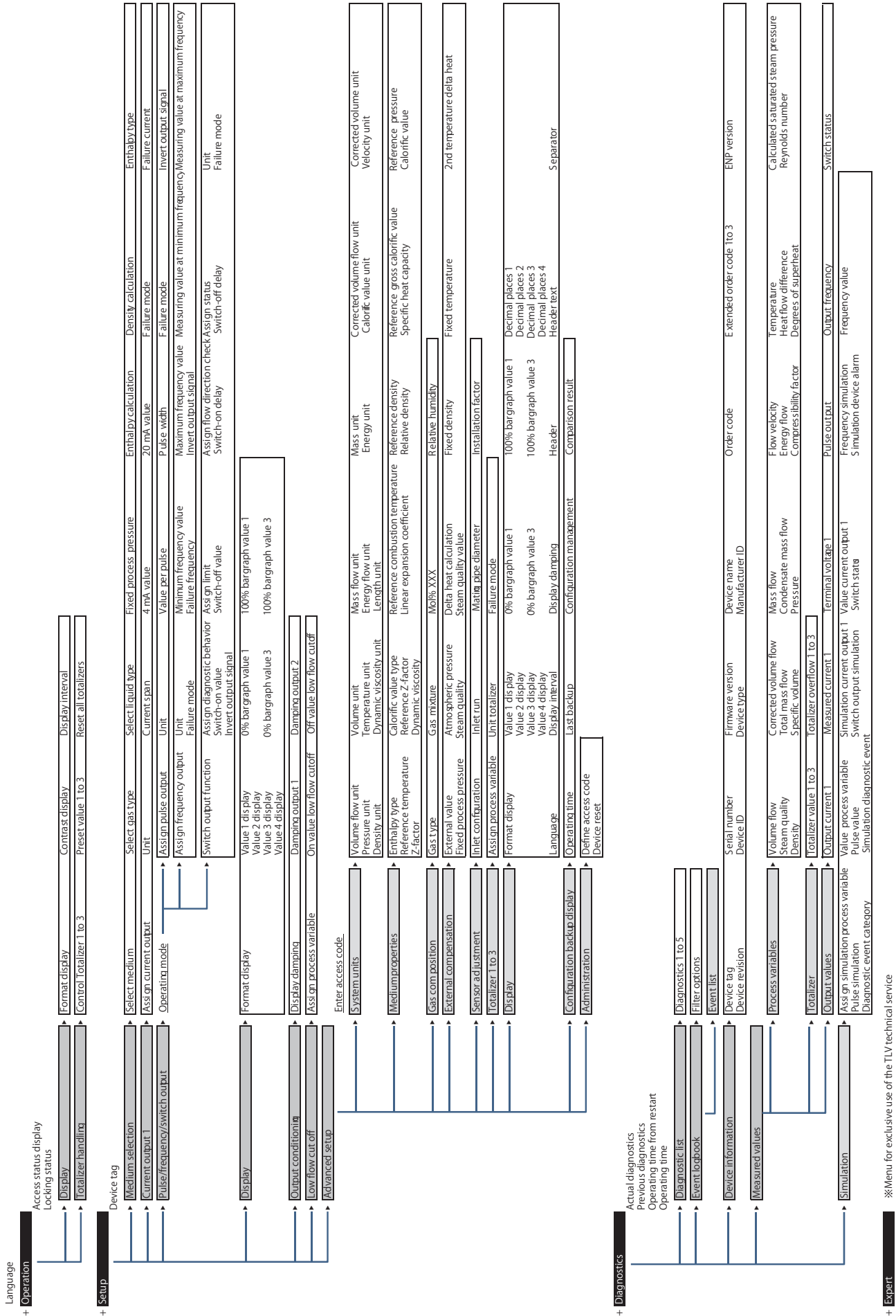

19 TLV EXPRESS LIMITED WARRANTY

Subject to the limitations set forth below, TLV CO., LTD., a Japanese corporation (“**TLV**”), warrants that products which are sold by it, TLV International Inc. (“**TII**” of its group companies excluding TLV Corporation (a corporation of the United States of America), (hereinafter the “**Products**”) are designed and manufactured by TLV, conform to the specifications published by TLV for the corresponding part numbers (the “**Specifications**”) and are free from defective workmanship and materials. The party from whom the Products were purchased shall be known hereinafter as the “**Seller**”. With regard to products or components manufactured by unrelated third parties (the “**Components**”), TLV provides no warranty other than the warranty from the third party manufacturer(s), if any.

Exceptions to Warranty

This warranty does not cover defects or failures caused by:

1. improper shipping, installation, use, handling, etc., by persons other than TLV, TII or TLV group company personnel, or service representatives authorized by TLV; or
2. dirt, scale or rust, etc.; or
3. improper disassembly and reassembly, or inadequate inspection and maintenance by persons other than TLV or TLV group company personnel, or service representatives authorized by TLV; or
4. disasters or forces of nature or Acts of God; or
5. abuse, abnormal use, accidents or any other cause beyond the control of TLV, TII or TLV group companies; or
6. improper storage, maintenance or repair; or
7. operation of the Products not in accordance with instructions issued with the Products or with accepted industry practices; or
8. use for a purpose or in a manner for which the Products were not intended; or
9. use of the Products in a manner inconsistent with the Specifications; or
10. use of the Products with Hazardous Fluids (fluids other than steam, air, water, nitrogen, carbon dioxide and inert gases (helium, neon, argon, krypton, xenon and radon)); or
11. failure to follow the instructions contained in the TLV Instruction Manual for the Product.

Duration of Warranty

This warranty is effective for a period of one (1) year after delivery of Products to the first end user. Notwithstanding the foregoing, asserting a claim under this warranty must be brought within three (3) years after the date of delivery to the initial buyer if not sold initially to the first end user.

ANY IMPLIED WARRANTIES NOT NEGATED HEREBY WHICH MAY ARISE BY OPERATION OF LAW, INCLUDING THE IMPLIED WARRANTIES OF MERCHANTABILITY AND FITNESS FOR A PARTICULAR PURPOSE AND ANY EXPRESS WARRANTIES NOT NEGATED HEREBY, ARE GIVEN SOLELY TO THE INITIAL BUYER AND ARE LIMITED IN DURATION TO ONE (1) YEAR FROM THE DATE OF SHIPMENT BY THE SELLER.

Exclusive Remedy

THE EXCLUSIVE REMEDY UNDER THIS WARRANTY, UNDER ANY EXPRESS WARRANTY OR UNDER ANY IMPLIED WARRANTIES NOT NEGATED HEREBY (INCLUDING THE IMPLIED WARRANTIES OF MERCHANTABILITY AND FITNESS FOR A PARTICULAR PURPOSE), IS **REPLACEMENT**; PROVIDED: (a) THE CLAIMED DEFECT IS REPORTED TO THE SELLER IN WRITING WITHIN THE WARRANTY PERIOD, INCLUDING A DETAILED WRITTEN

DESCRIPTION OF THE CLAIMED DEFECT AND HOW AND WHEN THE CLAIMED DEFECTIVE PRODUCT WAS USED; AND (b) THE CLAIMED DEFECTIVE PRODUCT AND A COPY OF THE PURCHASE INVOICE IS RETURNED TO THE SELLER, FREIGHT AND TRANSPORTATION COSTS PREPAID, UNDER A RETURN MATERIAL AUTHORIZATION AND TRACKING NUMBER ISSUED BY THE SELLER. ALL LABOR COSTS, SHIPPING COSTS, AND TRANSPORTATION COSTS ASSOCIATED WITH THE RETURN OR REPLACEMENT OF THE CLAIMED DEFECTIVE PRODUCT ARE SOLELY THE RESPONSIBILITY OF BUYER OR THE FIRST END USER. THE SELLER RESERVES THE RIGHT TO INSPECT ON THE FIRST END USER'S SITE ANY PRODUCTS CLAIMED TO BE DEFECTIVE BEFORE ISSUING A RETURN MATERIAL AUTHORIZATION. SHOULD SUCH INSPECTION REVEAL, IN THE SELLER'S REASONABLE DISCRETION, THAT THE CLAIMED DEFECT IS NOT COVERED BY THIS WARRANTY, THE PARTY ASSERTING THIS WARRANTY SHALL PAY THE SELLER FOR THE TIME AND EXPENSES RELATED TO SUCH ON-SITE INSPECTION.

Exclusion of Consequential and Incidental Damages

IT IS SPECIFICALLY ACKNOWLEDGED THAT THIS WARRANTY, ANY OTHER EXPRESS WARRANTY NOT NEGATED HEREBY, AND ANY IMPLIED WARRANTY NOT NEGATED HEREBY, INCLUDING THE IMPLIED WARRANTIES OF MERCHANTABILITY AND FITNESS FOR A PARTICULAR PURPOSE, DO NOT COVER, AND NEITHER TLV, TII NOR ITS TLV GROUP COMPANIES WILL IN ANY EVENT BE LIABLE FOR, INCIDENTAL OR CONSEQUENTIAL DAMAGES, INCLUDING, BUT NOT LIMITED TO LOST PROFITS, THE COST OF DISASSEMBLY AND SHIPMENT OF THE DEFECTIVE PRODUCT, INJURY TO OTHER PROPERTY, DAMAGE TO BUYER'S OR THE FIRST END USER'S PRODUCT, DAMAGE TO BUYER'S OR THE FIRST END USER'S PROCESSES, LOSS OF USE, OR OTHER COMMERCIAL LOSSES. WHERE, DUE TO OPERATION OF LAW, CONSEQUENTIAL AND INCIDENTAL DAMAGES UNDER THIS WARRANTY, UNDER ANY OTHER EXPRESS WARRANTY NOT NEGATED HEREBY OR UNDER ANY IMPLIED WARRANTY NOT NEGATED HEREBY (INCLUDING THE IMPLIED WARRANTIES OF MERCHANTABILITY AND FITNESS FOR A PARTICULAR PURPOSE) CANNOT BE EXCLUDED, SUCH DAMAGES ARE EXPRESSLY LIMITED IN AMOUNT TO THE PURCHASE PRICE OF THE DEFECTIVE PRODUCT. THIS EXCLUSION OF CONSEQUENTIAL AND INCIDENTAL DAMAGES, AND THE PROVISION OF THIS WARRANTY LIMITING REMEDIES HEREUNDER TO REPLACEMENT, ARE INDEPENDENT PROVISIONS, AND ANY DETERMINATION THAT THE LIMITATION OF REMEDIES FAILS OF ITS ESSENTIAL PURPOSE OR ANY OTHER DETERMINATION THAT EITHER OF THE ABOVE REMEDIES IS UNENFORCEABLE, SHALL NOT BE CONSTRUED TO MAKE THE OTHER PROVISIONS UNENFORCEABLE.

Exclusion of Other Warranties

THIS WARRANTY IS IN LIEU OF ALL OTHER WARRANTIES, EXPRESS OR IMPLIED, AND ALL OTHER WARRANTIES, INCLUDING BUT NOT LIMITED TO THE IMPLIED WARRANTIES OF MERCHANTABILITY AND FITNESS FOR A PARTICULAR PURPOSE, ARE EXPRESSLY DISCLAIMED.

Severability

Any provision of this warranty which is invalid, prohibited or unenforceable in any jurisdiction shall, as to such jurisdiction, be ineffective to the extent of such invalidity, prohibition or unenforceability without invalidating the remaining provisions hereof, and any such invalidity, prohibition or unenforceability in any such jurisdiction shall not invalidate or render unenforceable such provision in any other jurisdiction.

20 Service

For Service or Technical Assistance: Contact your TLV representative or your TLV office.

In Europe:

TLV EURO ENGINEERING GmbH

Daimler-Benz-Straße 16-18, 74915 Waibstadt, **Germany**

Tel: [49]-(0)7263-9150-0
Fax: [49]-(0)7263-9150-50

TLV EURO ENGINEERING UK LTD.

Units 7 & 8, Furlong Business Park, Bishops Cleeve,
Gloucestershire GL52 8TW, **U.K.**

Tel: [44]-(0)1242-227223
Fax: [44]-(0)1242-223077

TLV EURO ENGINEERING FRANCE SARL

Parc d'Ariane 2, bât. C, 290 rue Ferdinand Perrier, 69800 Saint Priest,
France

Tel: [33]-(0)4-72482222
Fax: [33]-(0)4-72482220

In North America:

TLV CORPORATION

13901 South Lakes Drive, Charlotte, NC 28273-6790, **U.S.A.**

Tel: [1]-704-597-9070
Fax: [1]-704-583-1610

In Mexico and Latin America:

TLV ENGINEERING S. A. DE C.V.

Av. Jesús del Monte 39-B-1001, Col. Hda. de las Palmas, Huixquilucan,
Edo. de México, 52763, **Mexico**

Tel: [52]-55-5359-7949
Fax: [52]-55-5359-7585

In Oceania:

TLV PTY LIMITED

Unit 8, 137-145 Rooks Road, Nunawading, Victoria 3131, **Australia**

Tel: [61]-(0)3-9873 5610
Fax: [61]-(0)3-9873 5010

In East Asia:

TLV PTE LTD

36 Kaki Bukit Place, #02-01/02, **Singapore** 416214

Tel: [65]-6747 4600
Fax: [65]-6742 0345

TLV SHANGHAI CO., LTD.

5/F, Building 7, No.103 Caobao Road, Xuhui District, Shanghai, **China**
200233

Tel: [86]-(0)21-6482-8622
Fax: [86]-(0)21-6482-8623

TLV ENGINEERING SDN. BHD.

No.16, Jalan MJ14, Taman Industri Meranti Jaya, 47120 Puchong,
Selangor, **Malaysia**

Tel: [60]-3-8052-2928
Fax: [60]-3-8051-0899

TLV PRIVATE LIMITED

252/94 (K-L) 17th Floor, Muang Thai-Phatra Complex Tower B,
Rachadaphisek Road, Huaykwang, Bangkok 10310, **Thailand**

Tel: [66]-2-693-3799
Fax: [66]-2-693-3979

TLV INC.

#302-1 Bundang Technopark B, 723 Pangyo-ro, Bundang, Seongnam,
Gyeonggi, 13511, **Korea**

Tel: [82]-(0)31-726-2105
Fax: [82]-(0)31-726-2195

In the Middle East:

TLV ENGINEERING FZCO

Building 2W, No. M002, PO Box 371684, Dubai Airport Free Zone,
Dubai, **UAE**

Email: sales-me@tlv.co.jp

In Other Countries:

TLV INTERNATIONAL, INC.

881 Nagasuna, Noguchi, Kakogawa, Hyogo 675-8511, **Japan**

Tel: [81]-(0)79-427-1818
Fax: [81]-(0)79-425-1167

Manufacturer:

TLV CO., LTD.

881 Nagasuna, Noguchi, Kakogawa, Hyogo 675-8511, **Japan**

Tel: [81]-(0)79-427-1800
Fax: [81]-(0)79-422-2277