

TLV[®]

Free Float[®] Steam Trap Series

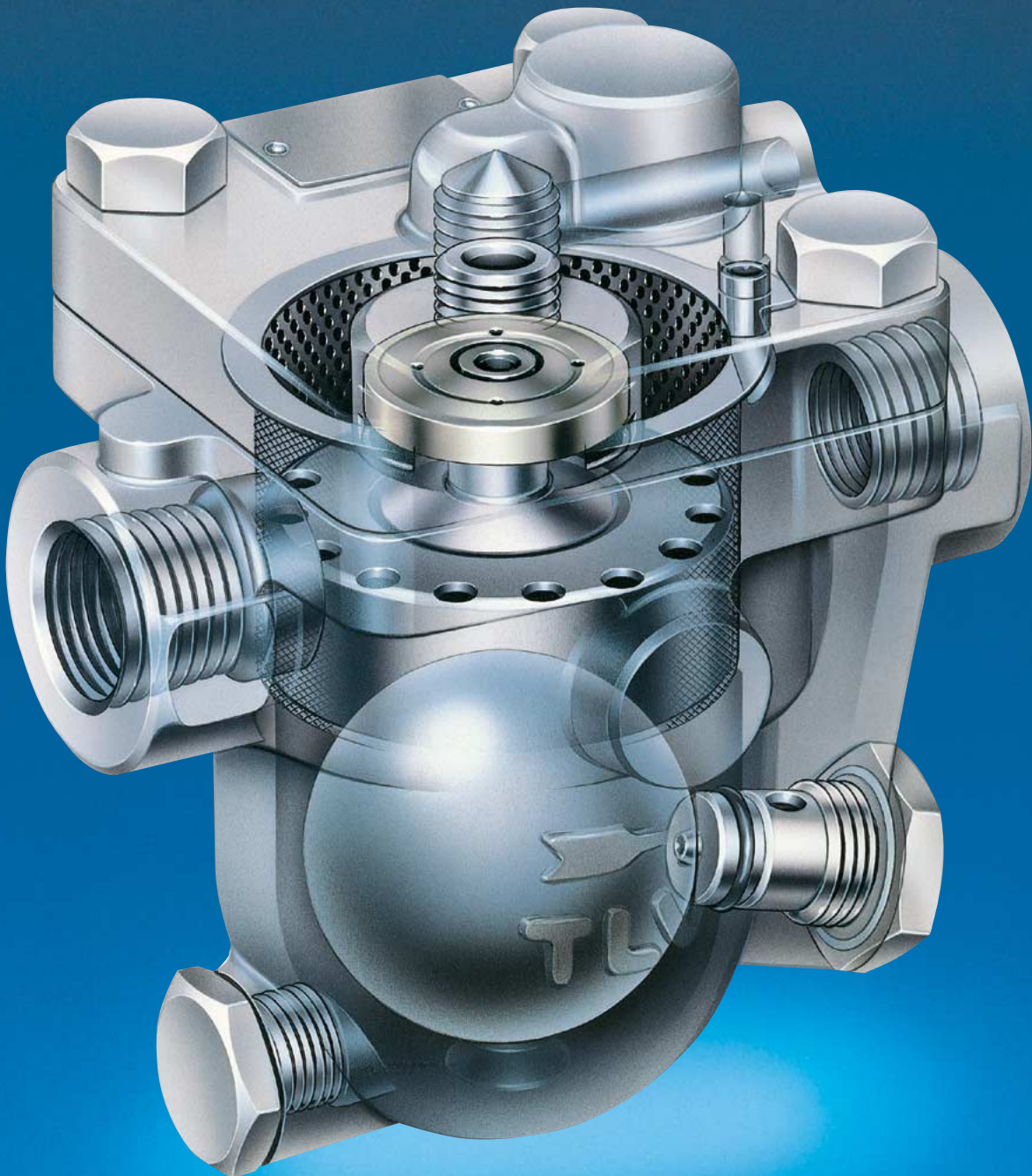

Free Float® Steam Traps Revolutionizing Fluid Control Technology



“Free Float”®

More than 50 years have passed since TLV introduced the free float concept to the steam industry. Since then, TLV’s free float traps and other innovative technologies have enabled users to achieve exceptional performance in facility after facility worldwide.

Free Float Principle

The failure of mechanical steam traps is related to their number of moving parts. TLV free float traps have only one moving part, the float. Compared to complex mechanical traps such as the inverted bucket with its levers and hinges, TLV free float traps mean fewer failures and long service life.

Precision-ground Spherical Float

For most TLV free float trap models, a unique grinding process virtually eliminates the welding seam, finishing the float to be almost perfectly spherical. These floats have unmatched sealing performance with the valve seat to prevent steam loss, and they are designed for severe service operation. Even at high pressures, they provide excellent durability and resistance to water hammer, ensuring long and reliable operation.

Simple Is Best!

Free float technology manifests TLV’s product philosophy.

The First Choice for Process Efficiency

The Reasons are Simple

1 Process Efficiency

The TLV free float adjusts quickly to changes in condensate flow, ensuring rapid discharge and maximum process efficiency. Unaffected by back pressure, the TLV free float is ideal wherever condensate is recovered.

2 Energy Conservation

A valve orifice below "water level" and three-point seating in some models prevent steam leakage.

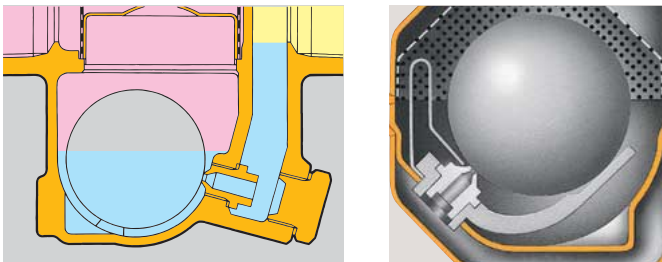

3 Integral Strainer

All internals are protected by an integral perforated stainless steel strainer screen.*

* except JL and J10 Series

4 Long Life

The precision ground float provides an infinite number of contact surfaces with the orifice, ensuring little wear and long reliable life.

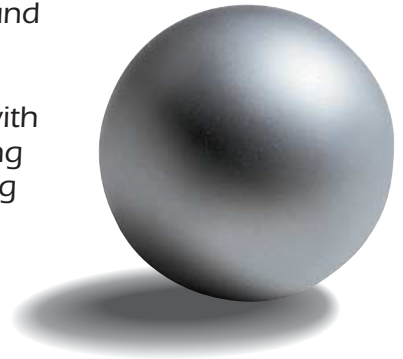

5 Automatic Air Venting

Automatic air venting discharges initial air so the equipment can be started up in the shortest possible time period. X-element also vents air at near steam temperature, suitable for batch operation equipment.

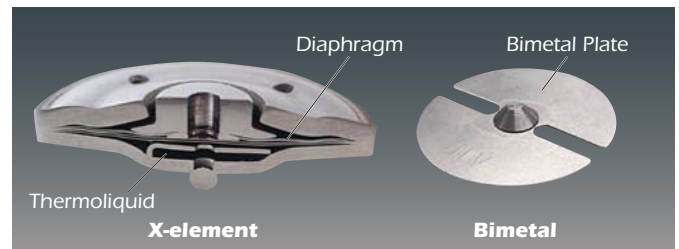

FREE FLOAT® OPERATION (X-element)

1 Start-up Discharge

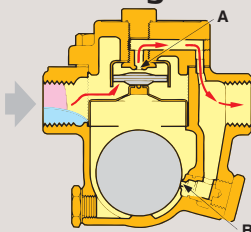

When trap is cool, the X-element contracts and valve port (A) opens wide, continuously discharging initial air. As cold condensate enters the trap, the float rises to allow discharge of condensate from valve port (B) and both air and condensate from valve port (A).

2 Hot Condensate Discharge

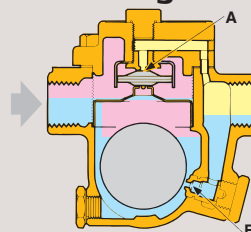

Once all initial air and cold condensate have been discharged, hot condensate heats the X-element and closes valve port (A) before steam can escape. Condensate which simultaneously enters the trap continues to be discharged through valve port (B).

3 Continuous Response

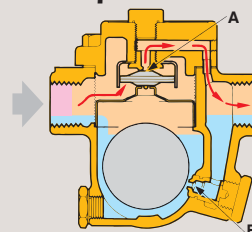

Air or retained condensate entering the trap drop the temperature and contract the X-element. Valve port (A) instantaneously opens to discharge both air and condensate. When higher temperature condensate follows, the X-element expands and closes valve port (A).

4 Complete Closure

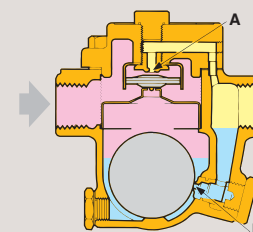

When condensate flow to the trap ceases, the float closes valve port (B) which is always sealed below the water level. The upper section fills with steam, closing valve port (A). The trap is then completely sealed, preventing any steam leakage.

THE CHOICE IS TLV'S **JX/JH-X/JH-B SERIES** TO MAXIMIZE ALL OF THE REQUIREMENTS OF A PROCESS STEAM TRAP'S FUNCTION

Functions Required of Process Traps

Improved Heating Efficiency and Production Quality

TLV's free float immediately adjusts the valve opening to perfectly match the amount of entering condensate. Condensate is continuously discharged, so no condensate backs up into equipment allowing process temperature to be maintained.

The Optimal Air Vent for Any Application

The JX and JH series offer a variety of air vents and venting devices to offer an optimized solution for any application. From rapid air venting to extremely high-pressure applications, TLV offers an air vent to fit even the most demanding needs.

Integral Automatic Air Vent

The JX and JH-X series steam traps operate stress-free and their X-element type automatic air vents provide for rapid removal of air and non-condensable gases at start-up and during normal operation.

The JH-B series features a bimetal type automatic air vent for durable high temperature service and rapid start-up.

■ JX, JH-X Series

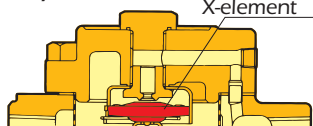

X-element

■ JH-B Series

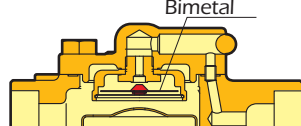

Bimetal

Optional Venting Devices

Other JH series steam traps can be optionally equipped with automatic LEX air venting capability. For rotating can service, a lock release valve (needle valve) or drilled air vent is available on many JX and JH-X steam traps.*

■ J3X, J5X

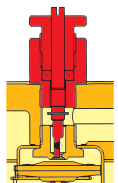

Lock Release Valve

■ JX, JH-X Series

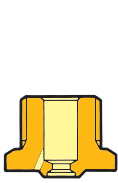

Drilled Vent

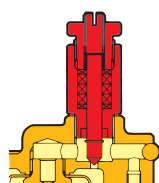

Needle Valve

■ JH Series

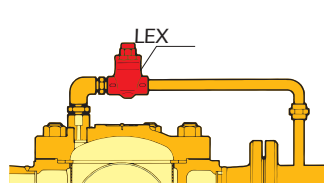

External LEX

*contact TLV for available models

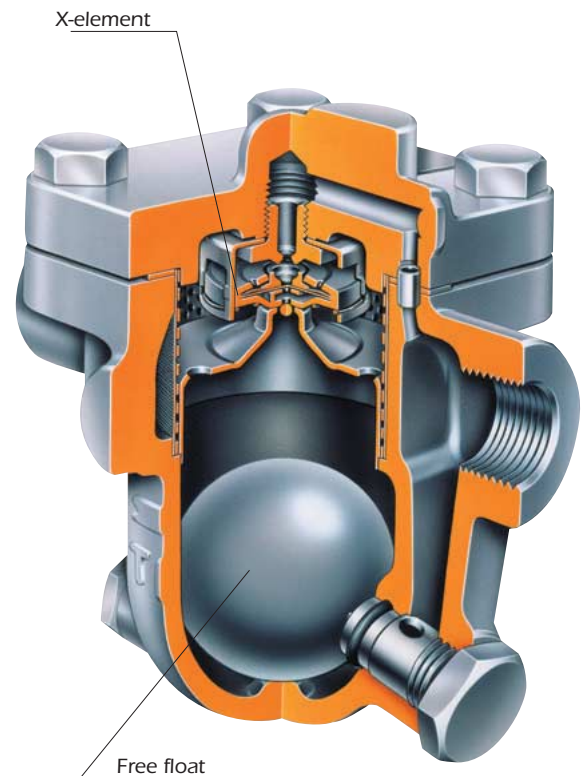

X-element

Free float

Common Features

Built-in Strainer

These steam traps also feature an integral screen with large surface area to extend trouble-free operation.

Inline Repairable

JX, JH-X and JH-B series steam traps are equipped with a removable cover to provide ease of inspection or maintenance without disturbing the piping.



JX Series

Low-to-Med. Pressure

Small-to-Large Process

Medium Temperature

HVAC

Application: Heat Exchanger

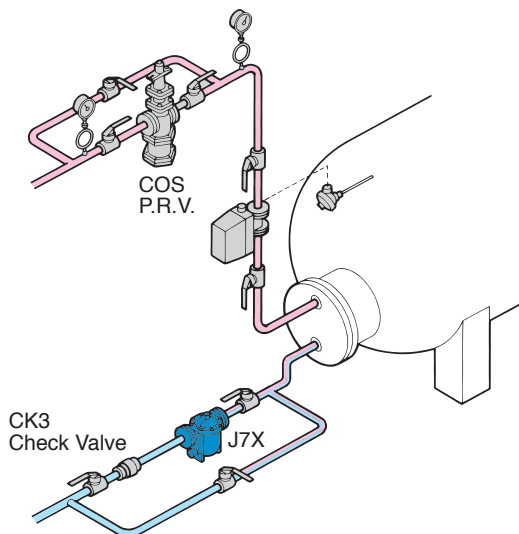

- Cast iron, ductile cast iron, or stainless steel traps for low-to-medium pressure.
- J3S-X, J5S-X and J6S-X have stainless steel bodies, and three-point seating design which ensures a steam-tight seal.
- Automatic X-element air vent for fast start-up and venting air at close-to-steam temperature.
- Externally removable orifice for inline inspection and repair.
- Internal float cover shields and protects float from water hammer.
- Reusable cover gaskets on J3X, J5X, J3S-X, J5S-X, J6S-X and J7X save maintenance costs.

No.	Description/Material
①	Body/Cast Iron, Ductile Cast Iron, or Stainless Steel
②	Cover/Cast Iron, Ductile Cast Iron, or Stainless Steel
③	Float/Stainless Steel
④	Orifice/-
⑤	Screen/Stainless Steel
⑥	X-element/Stainless Steel
⑦	Air Vent Seat/Stainless Steel

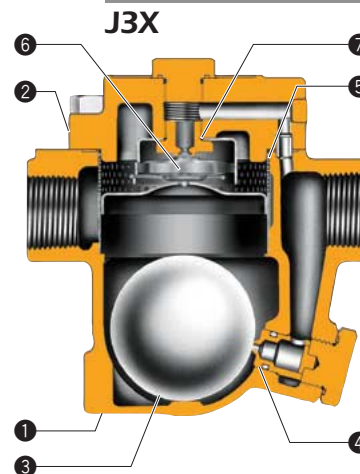

JH-X Series

Low-to-High Pressure

Small-to-Large Process

Medium Temperature

Process Heater

Application: Heater Battery

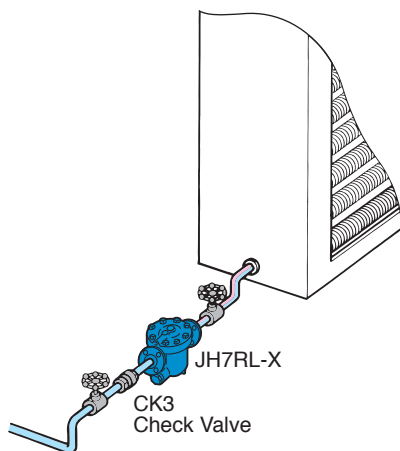

- Cast steel or stainless steel traps for low-to-high pressure.
- Automatic X-element air vent for fast start-up and venting air at close-to-steam temperature.
- On most models, three-point seating design ensures a steam-tight seal.
- Externally removable orifice for inline inspection and repair.
- Internal float cover shields and protects float from water hammer.

No.	Description/Material
①	Body/Cast Steel or Stainless Steel
②	Cover/Forged Carbon Steel or Stainless Steel
③	Float/Stainless Steel
④	Orifice/-
⑤	Screen/Stainless Steel
⑥	X-element/Stainless Steel

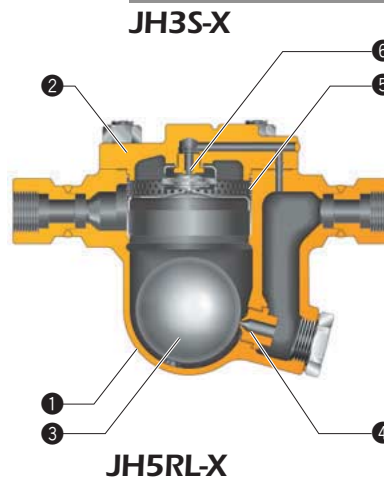

Model	J3X	J3S-X**	J5X	J5S-X**	J6S-X**	J7X	J7.2X	J7.5X	J8X	JH3S-X**	JH5SL-X**	JH5RL-X**	JH7RL-X**	JH7.2R-X	JH7.5R-X	JH7.5R-XE**	JH8R-X
Connection*	S F	S,F	S F	S,F	S	S,F	F	F	F	S,W,F	S,W	S,W,F	S,W,F	W,F	F	W	F
Max. Allowable Pressure PMA (psig)	300 250	300	300 250	300	300	250	250	250	250	450	600	600	600	650	650	710	650
Max. Allowable Temperature TMA (°F)	428 428	428	428 428	428	428	428	428	428	428	662	800	800	800	800	800	800	800

* S = screwed, W = socket weld, F = flanged ** Three-point seating type

JH-B Series

Low-to-High Pressure	Small-to-Large Process
Med.-to-High Temperature	Process Heater

Application: Heater Batteries

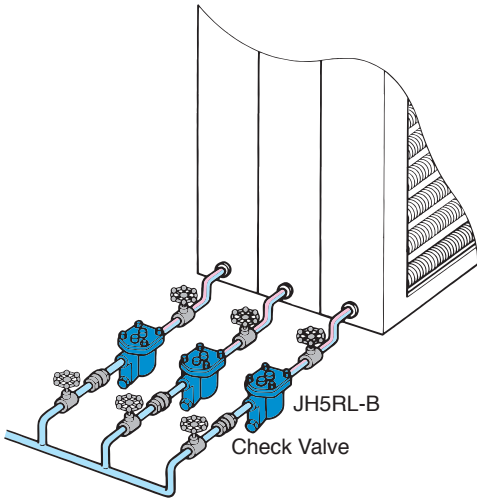

- Cast steel or stainless steel traps for low-to-high pressure.
- Automatic bimetal air vent for fast start-up.
- On most models, three-point seating design ensures a steam-tight seal.
- Externally removable orifice for inline inspection and repair.
- Internal float cover shields and protects float from water hammer.

No.	Description/Material
①	Body/Cast Steel or Stainless Steel
②	Cover/Forged Carbon Steel or Stainless Steel
③	Float/Stainless Steel
④	Orifice/-
⑤	Screen/Stainless Steel
⑥	Bimetal Plate/-



JH7RL-B

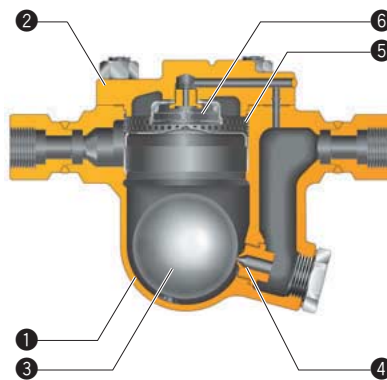

JH5RL-B

JH Series

High Pressure	Small-to-Large Process
High Temperature	Dowtherm

Application: Reactor for Dowtherm

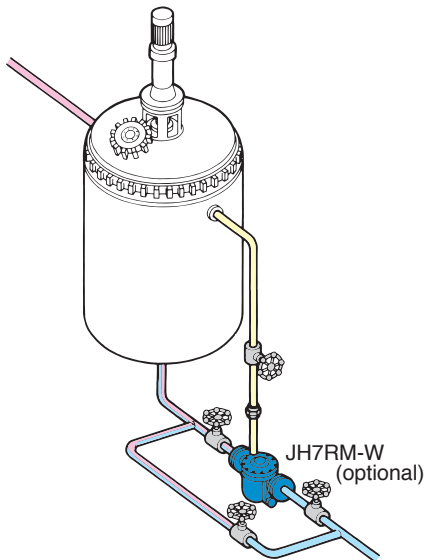

The JH7RH-W is designed for high-pressure/high-temperature applications. The JH series can be specially fitted with a cover connection (such as for Dowtherm applications) or an external air vent. A socket weld connection on the cover is available. Equipped with the same features as the JH-B series other than air venting.

Cover Connection

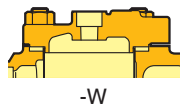

No.	Description/Material
①	Body/Cast Steel
②	Cover/Forged Carbon Steel
③	Float/Stainless Steel
④	Orifice/-
⑤	Screen/Stainless Steel



JH7RH-W (optional)

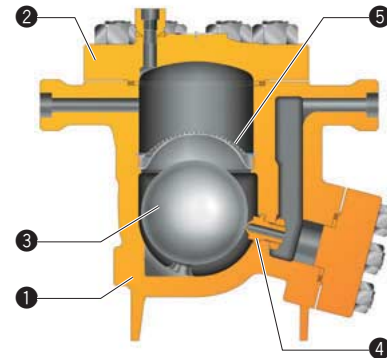

JH7RH-W (optional)

[Dowtherm is a trademark of Dow Chemical Co.]

Model	JH3S-B**	JH5SL-B**	JH5SH-B**	JH5RL-B**	JH5RH-B**	JH7RL-B**	JH7RM-B**	JH7RH-B**	JH7.2R-B	JH7.5R-B	JH7.5R-BE**	JH8R-B	JH7RH-W**
Connection*	S,W,F	S,W	W	S,W,F	W	W,F	S,W,F	W	W,F	F	W	F	W
Max. Allowable Pressure PMA (psig)	450	650	925	650	1150	650	925	1740	650	650	710	650	1740
Max. Allowable Temperature TMA (°F)	662	800	800	800	800	800	800	800	800	800	800	800	986

* S = screwed, W = socket weld, F = flanged ** Three-point seating type

FS-SS-SH Series

Common Features

Three-point Seating

These designs include “three-point” seating of the float for seal-tight shutoff with no steam loss even under low condensate flow condition.

Three-point Seating



Automatic Air Vent

Integral bimetal thermostatic air vent offers quick start-up and high resistance to water hammer.



Inline Repairable

Removable cover (except FS3/5, and SS3/5) to provide ease of inspection or maintenance without disturbing the piping.



FS Series

Medium Pressure

Small Process

Medium Temperature

Drip/Tracer

Application: Jacketed Tracer

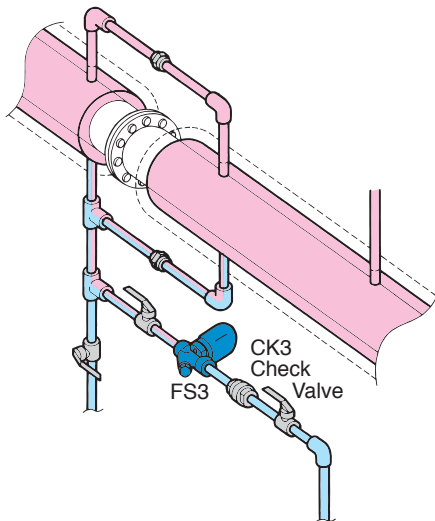

- Stainless steel trap with two-bolt universal connector facilitates installation and replacement.
- Universal flange permits correct installation in vertical and horizontal piping. (QuickTrap)
- All-welded maintenance-free trap body.

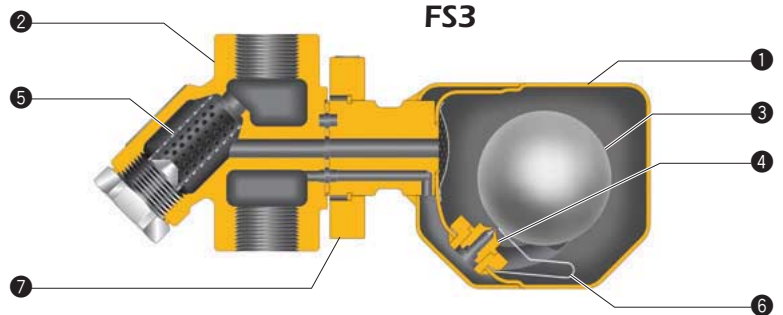

No.	Description/Material	No.	Description/Material
①	Trap Body/Stainless Steel	⑤	Screen/Stainless Steel
②	Connector Body/Cast Stainless Steel	⑥	Air Vent Strip/Bimetal
③	Float/Stainless Steel	⑦	Flange/Forged Carbon Steel
④	Orifice/-		

Model	FS3	FS5	FS5H
Connection*	S, W, F	S, W, F	S, W, F
Max. Allowable Pressure PMA (psig)	345	450	650
Max. Allowable Temperature TMA (°F)	752	752	800

* S = screwed, W = socket weld, F = flanged

SS Series

Medium Pressure	Small Process
Medium Temperature	Drip/Tracer

Application: Tracer

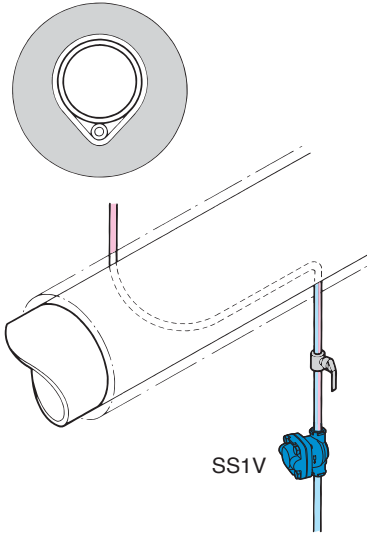

- All stainless steel traps for medium pressure.
- SS1N/V* with removable cover for inspection and maintenance.
- SS3N/V*, SS5N/V*, SS5NH/VH* with all-welded maintenance-free body.
- Recommended for superheat.



SS3V

SS1N

* "N" for horizontal installation, "V" for vertical installation

No.	Description/Material
①	Body/Stainless Steel
②	Cover/Stainless Steel
③	Valve Seat/-
④	Screen/Stainless Steel
⑤	Air Vent Strip/Bimetal
⑥	Insulation Cover (optional, not shown)

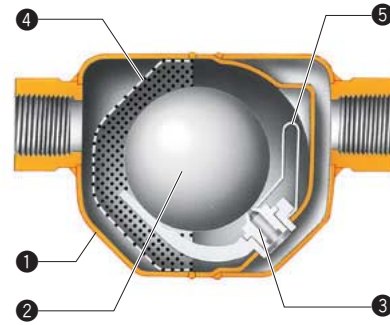

SS3N

SH Series

High Pressure	Small to Medium Process
Superheat	Drip/Turbine

Application: Main (Drip)

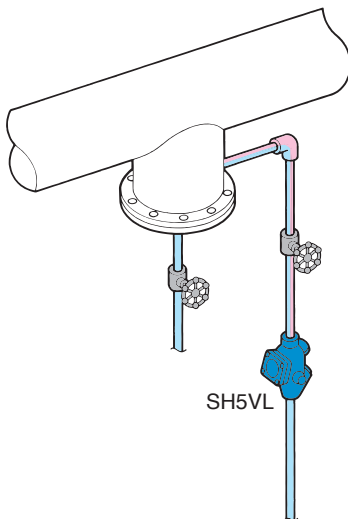

- Cast steel traps for high pressure.
- Steam-tight, even under low condensate flow conditions.
- SH series traps offer horizontal installation, SH5VL offers vertical installation.
- Recommended for superheat.



SH5VL

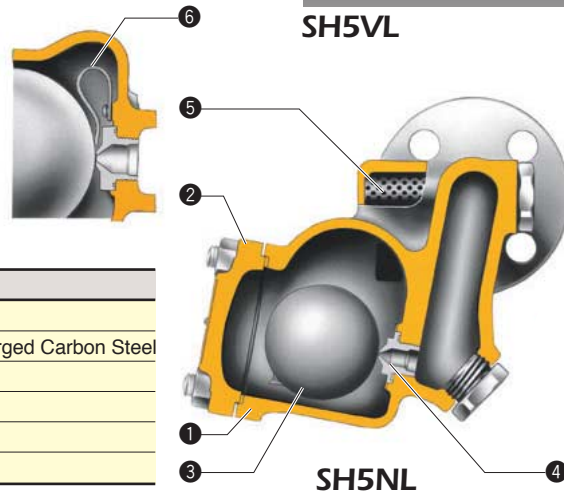

SH5NL

No.	Description/Material
①	Body/Cast Steel
②	Cover/Cast Steel or Forged Carbon Steel
③	Float/Stainless Steel
④	Orifice/-
⑤	Screen/Stainless Steel
⑥	Air Vent Strip/Bimetal

Model	SS1NL/VL	SS1NH/VH	SS3N/V	SS5N/V	SS5NH/VH	SH5VL	SH5NL	SH5NH	SH6NL	SH6NH
Connection*	S	S	S, F**	S	S, W	S, W	W, F	W, F	W, F	W
Max. Allowable Pressure PMA (psig)	300	300	345	650	650	925	925	1150	925	1500
Max. Allowable Temperature TMA (°F)	428	662	752	800	800	800	800	800	800	800

* S = screwed, W = socket weld, F = flanged ** SS3V: S only

Process Float Series

J10, JH15

Medium-to-High Pressure

Extra Large Process

Medium-to-High Temperature

Extra Large Heater

■ Application: Large Re-Boiler

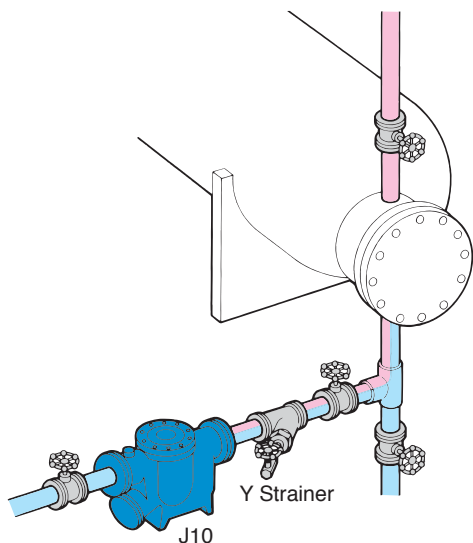

Float Dynamic Principle:

When a large quantity of condensate flows into the trap, the float rises immediately, opening the orifice (E) wide. Condensate passes through the pilot orifice at a high velocity into the control chamber (F), where the pressure increases rapidly due to flashing condensate. The rapid expansion causes a force to be exerted on the piston, opening the large orifice instantly. As condensate discharges through the main orifice at high velocity, condensate in the equipment is induced into the trap for rapid discharge.

No.	Description/Material
①	Body/Cast Iron (J10) or Cast Steel (JH15)
②	Cover/Cast Iron (J10) or Carbon Steel (JH15)
③	Float/Stainless Steel
④	Valve Seat/-
⑤	Air Vent/Stainless Steel



JH15

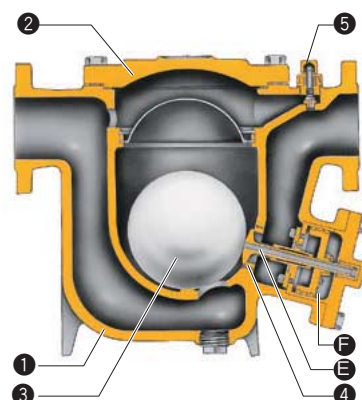

J10

JL Series

Low-to-Medium Pressure

Extra Large Process

Medium Temperature

Extra Large Heater

■ Application: Large Re-Boiler

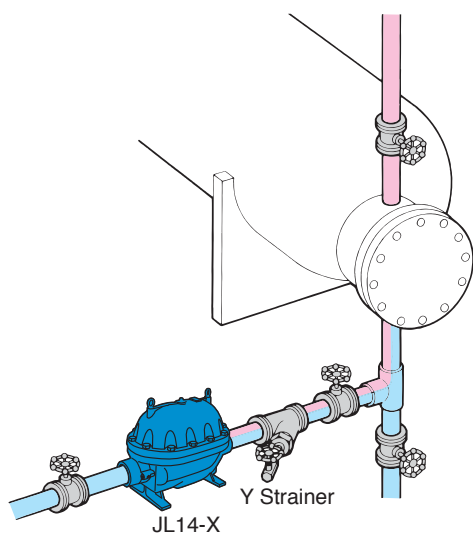

- Extremely durable, inline repairable cast iron or cast steel float trap for low-to-medium pressure.
- Automatic X-element air vent for fast start-up.
- Large double-seated valve with heat treat hardened working surfaces.
- Excellent resistance to water hammer.
- Inline inlet and outlet.

No.	Description/Material
①	Body/Cast Iron (JL9X, JL14-X) or Cast Steel (JLH9X, JLH14-X)
②	Cover/Cast Iron (JL9X, JL14-X) or Cast Steel (JLH9X, JLH14-X)
③	Float/Stainless Steel
④	Lever Unit/Stainless Steel
⑤	Trap Unit/Stainless Steel
⑥	X-element Air Vent/Stainless Steel



JL14-X

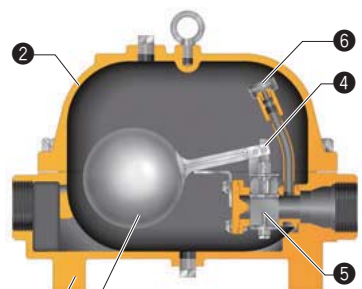

JL9X

Model	J10	JH15	JL9X	JLH9X	JL14-X	JLH14-X
Connection*	F	F	S, F	S, W, F	S, F	S, W, F
Max. Allowable Pressure PMA (psig)	250	710	250	450	250	450
Max. Allowable Temperature TMA (°F)	428	800	428	752	428	752

* S = screwed, W = socket weld, F = flanged

Selection Guide

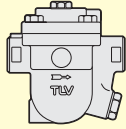
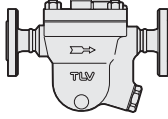
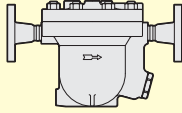
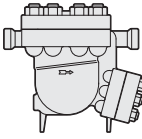
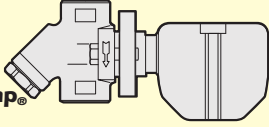
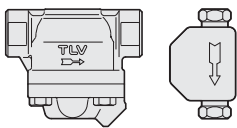
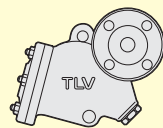
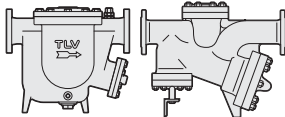
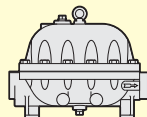
Model	Operating Pressure Range (psig)	Maximum Operating Temp (°F) TMO	Maximum Operating Capacity (lb/h)	Air Venting	Body Material	Application
JX Series 	Vacuum - 300	428	47,520	Automatic X-element	Cast Iron, Ductile Iron or Stainless Steel	Heat Exchangers Tank Heaters Coils, Dryers Unit Heaters Process Equipment
JH-X Series 	Vacuum - 450	464	40,000	Automatic X-element	Cast Steel or Stainless Steel	Heat Exchangers Tank Heaters Coils, Dryers Unit Heaters Process Equipment
JH-B Series 	1.5 - 1,500	800	14,950	Automatic Bimetal	Cast Steel or Stainless Steel	Steam Mains Turbines Tracer Lines Process Heaters Heat Exchangers
JH Series 	Vacuum - 1,740	986	970	Optional Automatic LEX	Cast Steel or Low Alloy Cast Steel	Steam Mains Small to Medium Process Equipment
FS Series QuickTrap® 	1.5 - 650	800	1,510	Automatic Bimetal	Stainless Steel	Steam Mains Turbines Tracer Lines
SS Series 	1.5 - 650	800	1,510	Automatic Bimetal	Stainless Steel	Steam Mains Tracer Lines
SH Series 	1.5 - 1,500	800	2,110	Automatic Bimetal	Cast Steel	Superheated or High-Pressure Steam Mains Process Equipment
J10 JH15 	7 - 650	800	366,470	Manual Air Vent	Cast Iron (J10) Cast Steel (JH15)	Large Capacity Process Equipment Heat Exchangers Heaters
JL Series 	Vacuum - 450	464	133,560	Automatic X-element	Cast Iron (JL9X/JL14-X) Cast Steel (JLH9X/JLH14-X)	Large Capacity Process Equipment Heat Exchangers Heaters

The highest figures listed may not apply to all traps within each series.

Full product details (sizes, pressures, capacities and materials) are included in the individual specification data sheets (SDS).

Local regulations may restrict the use of these products to below the conditions quoted.

Contact TLV directly or your local representative for further information.

Special TLV free float traps available for: • Biotechnology Applications • Dowtherm
• Soot Blowing • Gas and Air Applications



CAUTION DO NOT DISASSEMBLE OR REMOVE THIS PRODUCT WHILE IT IS UNDER PRESSURE. Allow internal pressure of this product to equal atmospheric pressure and its surface to cool to room temperature before disassembling or removing. Failure to do so could cause burns or other injury. READ INSTRUCTION MANUAL CAREFULLY.

TLV CORPORATION

13901 South Lakes Drive, Charlotte, NC 28273-6790

Tel: 704-597-9070 Fax: 704-583-1610

E-mail: tlv@tlvengineering.com <https://www.tlv.com>

For Technical Service 1-800 "TLV TRAP"



Manufacturer
TLV CO., LTD.
Kakogawa, Japan
is approved by LRQA Ltd. to ISO 9001/14001

ISO 9001
ISO 14001

