



CYCLONE SEPARATOR TRAP FOR AIR

MODEL DC3A

SEPARATOR FOR AIR WITH BUILT-IN AIR TRAP

Benefits

Super Cyclone-Effect separator and air trap combination unit provides high-quality dry air.

1. Unique SCE separator's efficiency can deliver high quality air of up to 99.8% dryness.
2. Self-modulating free float air trap discharges condensate immediately.
3. Precision ground spherical float and positive three-point seating provide a complete seal, even under no-load conditions.
4. The large surface area of the built-in screen guarantees trouble-free service.
5. Only one moving part, the free float, reduces valve wear and increases service life.



Specifications

Model		DC3A		DC3*
Connection		Screwed	Flanged	Flanged
Size (in)		1/2, 3/4, 1	1 1/2, 2, 3, 4	6
Orifice No.		10		—
Maximum Operating Pressure (psig)	PMO	150		300
Maximum Differential Pressure (psi)	ΔPMX	150		—
Maximum Operating Temperature (°F)	TMO	212		428
Maximum Allowable Pressure (psig)	PMA	250 (300 for 3" & 4")		300
Maximum Allowable Temperature (°F)	TMA	428		428
Applicable Fluid**		Air		

* DC3: without air trap ** Do not use for toxic, flammable or otherwise hazardous fluids.

Connections and sizes in bold are standard

No.	Description*	Material	ASTM/AISI**	JIS	
①	Body	Ductile Cast Iron	A536	FCD450	
②	Separator	1/2" -2"	Cast Iron	A126 Cl.B	FC250
	Body	3", 4", DC3	Ductile Cast Iron	A536	FCD450
③	Trap Cover	1/2" -2"	Cast Iron	A126 Cl.B	FC250
		3", 4"	Ductile Cast Iron	A536	FCD450
④	Separator	1/2" -2"	Cast Stainless Steel	A351 Gr.CF8	—
		3", 4"	Cast Stainless Steel	A351 Gr.CF8	—
		DC3	Ductile Cast Iron	A536	FCD450
⑤	Float	Stainless Steel	AISI316L	SUS316L	
⑥	Float Cover	1/2" -2"	Cast Iron	A126 Cl.B	FC250
		3", 4"	Ductile Cast Iron	A536	FCD450
⑦	Guide Pin	Stainless Steel	AISI304	SUS304	
⑧	Trap Valve Seat	Stainless Steel/Nitrile Rubber	AISI303/D2000BF	SUS303/NBR	
⑨	Valve Seat Gasket	Fluorine Resin	PTFE	PTFE	
⑩	Trap Cover Gasket	Fluorine Resin	PTFE	PTFE	
⑪	Wave Spring	Stainless Steel	AISI301	SUS301	
⑫	Body Gasket	Fluorine Resin	PTFE	PTFE	
⑬	Screen	Stainless Steel	AISI304	SUS304	
⑭	Nameplate	Stainless Steel	AISI304	SUS304	
⑮	Float Cover Bolt	Stainless Steel	AISI304	SUS304	
⑯	Spring Washer	Stainless Steel	AISI304	SUS304	
⑰	Body Bolt	Carbon Steel	AISI1045	S45C	
⑱	Baffle**	Stainless Steel	AISI304	SUS304	
⑲	Baffle Bolt & Nut**	Stainless Steel	AISI304	SUS304	

* Parts shown are for DC3A, some parts may not apply for DC3
 ** Equivalent *** 3", 4", DC3; above float cover, not shown



To avoid abnormal operation, accidents or serious injury, DO NOT use this product outside of the specification range. Local regulations may restrict the use of this product to below the conditions quoted.

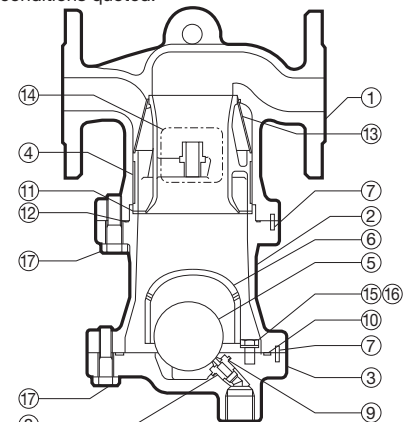

1/2" - 2" DC3A shown. 3", 4" DC3A and 6" DC3 configuration differs slightly.

Dimensions

● **DC3A Screwed**

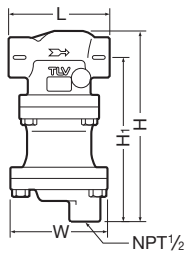

● **DC3A Flanged**

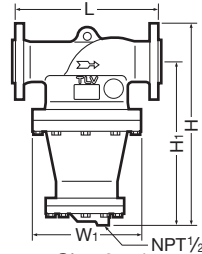
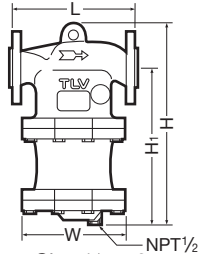

● **DC3 Flanged**

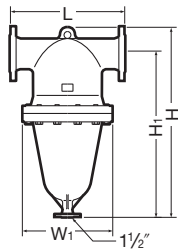

DC3, 6" requires the installation of an external air trap. Condensate discharge capacity depends on the trap used.

DC3A Screwed*

Size	L	H	H ₁	W	Weight (lb)
1/2	6 11/16	10 15/16	9 1/2	5 7/8	21
3/4					
1					

* NPT, other standards available

DC3A Flanged

Size	L				H	H ₁	W (φW ₁)	Weight* (lb)
	Connects to ASME Class							
	125FF	150RF	250RF	300RF				
1/2	8 3/8	—	8 7/8	***	13 7/8	10 9/16	6 1/2	40
2	9 3/16	—	10 3/8	***	16 7/16	12 5/8	7 11/16	69
3	—	14 3/4	—	15 1/8	20 1/2	16 15/16	11	(165)
4	—	17 1/16	—	17 11/16	25 3/8	20 1/2	13 3/4	(265)
6**	—	25 5/8	—	26 9/16	43 7/8	38	20 7/8	(816)

Other standards available, but length and weight may vary

* Weight is for Class 250 RF (300 RF) ** DC3

*** Consult TLV for ASME Class 300 RF with ductile cast iron body

Flange classes in bold are standard

Air Flow Rate

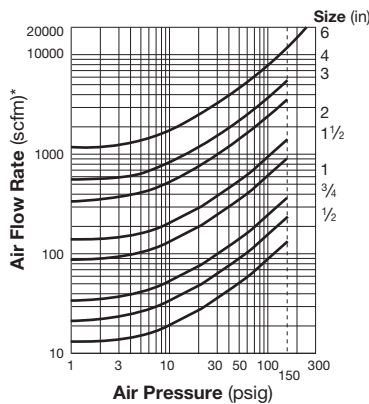

The chart at the left is used to determine the air flow rate through the DC3A separator. It is based on an air velocity of 100 ft/s. For other velocities, calculate the flow rate as follows:
 Flow rate at V ft/s = flow rate at 100 ft/s × $\frac{V}{100}$
 It is recommended that velocities not exceed 100 ft/s.

* Air at 68 °F and atmospheric pressure.

Pressure Loss

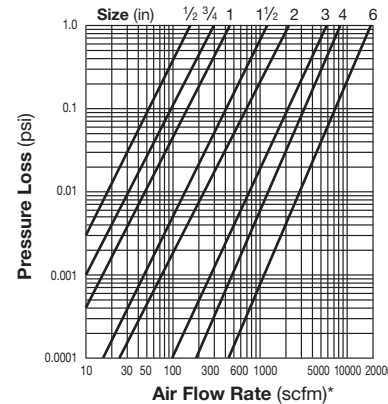

The pressure loss chart is based on an air pressure of 150 psig. For other pressures, multiply the air flow rate by the correction factor given in the table below. Use the result on the pressure loss chart.

* Air at 68 °F and atmospheric pressure.

Condensate Discharge Capacity

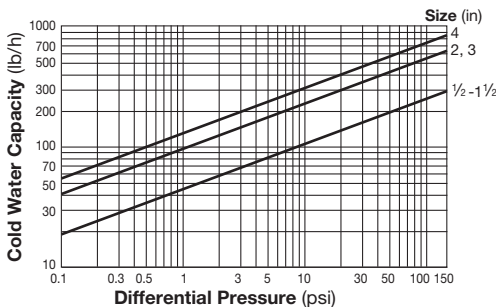

1. Differential pressure is the difference between the separator inlet and its trap outlet pressure.
2. Capacities are based on continuous discharge of condensate below 176 °F with specific gravity of 1.
3. Recommended safety factor: at least 1.5.

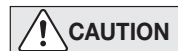

DO NOT use this product under conditions that exceed maximum differential pressure, as condensate backup will occur!



DO NOT DISASSEMBLE OR REMOVE THIS PRODUCT WHILE IT IS UNDER PRESSURE. Allow internal pressure of this product to equal atmospheric pressure and its surface to cool to room temperature before disassembling or removing. Failure to do so could cause burns or other injury. READ INSTRUCTION MANUAL CAREFULLY.

TLV CORPORATION

13901 South Lakes Drive, Charlotte, NC 28273-6790
 Tel: 704-597-9070 Fax: 704-583-1610
 E-mail: tlv@tlvengineering.com <https://www.tlv.com>
 For Technical Service 1-800 "TLV TRAP"



Manufacturer
TLV CO., LTD.
 Kakogawa, Japan
 is approved by LRQA Ltd. to ISO 9001/14001

