



# FREE FLOAT STEAM TRAP

## MODEL JH3X/JH3B

### CAST STEEL FREE FLOAT AND THERMOSTATIC STEAM TRAPS WITH THREE-POINT SEATING

#### Benefits

**Inline repairable traps with tight shut-off for drainage of superheated high pressure mains and turbines.**

1. Constant water seal and unique three-point seating ensure perfect steam-tight seal, even under no-load conditions.
2. Easy, inline access to internals to simplify cleaning and lower maintenance costs.
3. Up to 1740 psig hydraulic shock rating ensures excellent resistance of the float to water hammer.
4. Durable air vent provides exceptional performance.
5. Extremely soft near-to-steam, temperature discharge for safety and environmental considerations.
6. Built-in screen for extended trouble-free service.



U.S. Pat. 5,197,669 (JH3X)

#### Specifications

Model	JH3X			JH3B	
	Screwed	Socket Weld	Flanged	Screwed	Socket Weld
Connection					
Size (in)	1/2, 3/4, 1			1/2, 3/4, 1	
Orifice No.	2, 5, 10, 22, 32			32	
Maximum Operating Pressure (psig) PMO	30, 75, 150, 315, 450			450	
Maximum Differential Pressure (psi) ΔPMX	30, 75, 150, 315, 450			450	
Minimum Operating Pressure (psig)	Vacuum			1.5	
Maximum Operating Temperature (°F) TMO	464			662	
Maximum Allowable Pressure (psig) PMA	450			450	
Maximum Allowable Temperature (°F) TMA	662			662	
Type of Air Vent	X-element			Bimetal	

**CAUTION** To avoid abnormal operation, accidents or serious injury, DO NOT use this product outside of the specification range. Local regulations may restrict the use of this product to below the conditions quoted.

No.	Description	Material	ASTM/AISI*	JIS
①	Body	Cast Steel	A216 Gr. WCB	—
②	Cover (JH3B)	Cast Stainless Steel	A351 Gr. CF-8	SCS13A
②	Cover (JH3X)	Carbon Steel	A105	—
③MR	Cover Gasket	Stainl. St./Graphite	AISI316L	SUS316L
④F	Float	Stainless Steel	AISI316L	SUS316L
⑤R	Orifice	Stainless Steel	AISI420F	SUS420F
⑥R	Orifice Gasket	Soft Iron	AISI1010	SUYP
⑦R	X-element	Stainless Steel	—	—
⑧	Orifice Plug	Stainless Steel	AISI303	SUS303
⑨MR	Plug Gasket	Soft Iron	AISI1010	SUYP
⑩	Cover Bolt	Carbon Steel	AISI1045	S45C
⑪R	Screen	Stainless Steel	AISI430	SUS430
⑫R	Float Cover	Stainless Steel	AISI304	SUS304
⑬R	X-element Guide	Stainless Steel	AISI304	SUS304
⑭R	Air Vent Valve Seat	Stainless Steel	AISI420F	SUS420F
⑮	Connector	Stainless Steel	AISI416	SUS416
⑯R	Bimetal Air Vent	Bimetal	—	—
⑰R	Bimetal Cover	Stainless Steel	AISI304	SUS304
⑱MR	Valve Seat Gasket	Soft Iron	AISI1010	SUYP
⑲	Valve Plug	Stainless Steel	AISI416	SUS416
⑳R	Spring Clip	Stainless Steel	AISI304	SUS304
㉑R	Snap Ring	Stainless Steel	AISI304	SUS304
㉒	Flange (JH3X)**	Carbon/Cast Steel***	A105/216 Gr. WCB	—
㉓	Drain Plug	Carbon Steel	AISI1045	S25C
㉔MR	Drain Plug Gasket	Soft Iron	AISI1010	SUYP

\* Equivalent. \*\* Shown on reverse \*\*\* Material depends on flange specifications  
Replacement kits available: (M) maintenance parts, (R) repair parts, (F) float

#### JH3X Connections and sizes in bold are standard

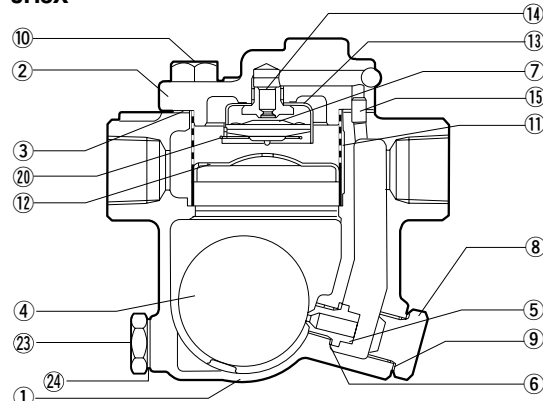

#### JH3B

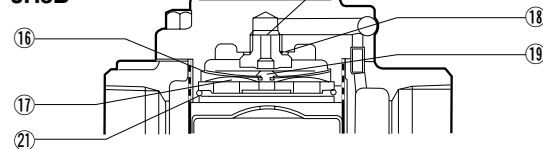

Drain plug location (inlet side or front-facing side) depends on connection type and size.

**Dimensions**

● **JH3X/JH3B**  
Screwed

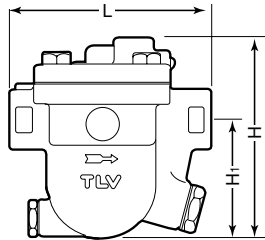

● **JH3X/JH3B**  
Socket Weld

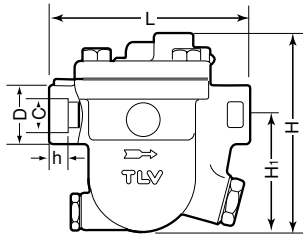

● **JH3X**  
Flanged

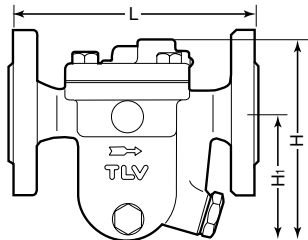

Sketches show JH3X. Configuration of JH3B differs slightly.

**JH3X/JH3B** Screwed\* (in)

Size	L	H	H <sub>1</sub>	Weight (lb)
1/2	5 1/8	5 1/4 (5 1/16)	3 1/4	6.7
3/4				
1	5 1/4	5 3/4 (5 9/16)	3 9/16	6.9

\* NPT, other standards available, ( ) : JH3B

**JH3X/JH3B** Socket Weld (in)

Size	L	H	H <sub>1</sub>	φ D	φ C	h	Weight (lb)
1/2	5 1/8	5 1/4 (5 1/16)	3 1/4	1 7/16	7/8	1/2	6.7
3/4						1 1/16	
1	5 1/4	5 3/4 (5 9/16)	3 9/16	1 3/4	1 3/8	9/16	6.9

( ) : JH3B

**JH3X** Flanged (in)

Size	L			H	H <sub>1</sub>	Weight* (lb)
	ASME Class					
	150RF	<b>300RF</b>	600RF			
1/2				5 3/4	3 9/16	10
3/4	8 1/4	8 1/4	8 1/4			12
1						13

Other standards available, but length and weight may vary

\* Weight is for Class 300/600 RF

**Flange classes in bold are standard**

**Discharge Capacity**

● **JH3X**

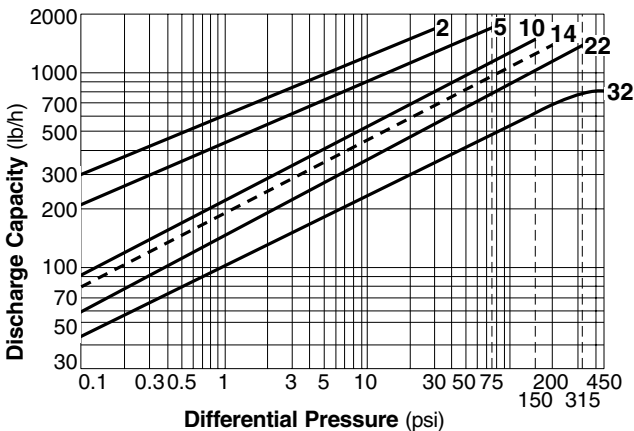

● **JH3B**

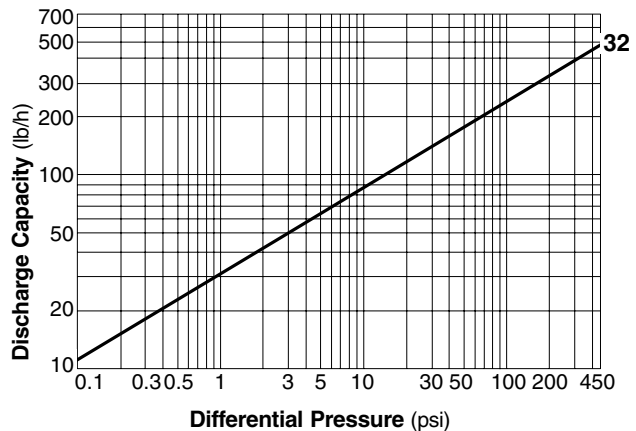

- Line numbers within the graph refer to orifice numbers.
- Differential pressure is the difference between the inlet and outlet pressure of the trap.
- Capacities are based on continuous discharge of condensate 11°F below saturated steam temperature.
- Recommended safety factor: at least 1.5.

— Standard    - - - - Available on special request

**CAUTION** DO NOT use traps under conditions that exceed maximum differential pressure, as condensate backup will occur!

**TLV CORPORATION**

13901 South Lakes Drive, Charlotte, NC 28273-6790  
 Phone: 704-597-9070 Fax: 704-583-1610  
 E-mail: tl@tlvengineering.com  
 For Technical Service 1-800 "TLV TRAP"



Manufacturer  
**TLV CO., LTD.**  
 Kakogawa, Japan  
 is approved by LRQA Ltd. to ISO 9001/14001

ISO 9001/ISO 14001

