



PowerTrap®

MODEL GT14L

COMPACT MECHANICAL PUMP WITH STEAM TRAP FOR CONDENSATE REMOVAL AND RECOVERY

Features

Pump/Trap with built-in steam trap for a wide range of applications: drainage of medium capacity heat exchangers, flash steam recovery systems and reservoirs, often operating under vacuum conditions.

1. Handles high-temperature condensate without cavitation.
2. No electric power or additional level controls required, hence **INTRINSICALLY SAFE**.
3. Pump will operate with a low filling head (min. 300 mm).
4. Easy, inline access to internal parts simplifies cleaning and reduces maintenance costs.
5. High-quality stainless steel internals and hardened working surfaces ensure reliability.
6. Compact design permits installation in a limited space.

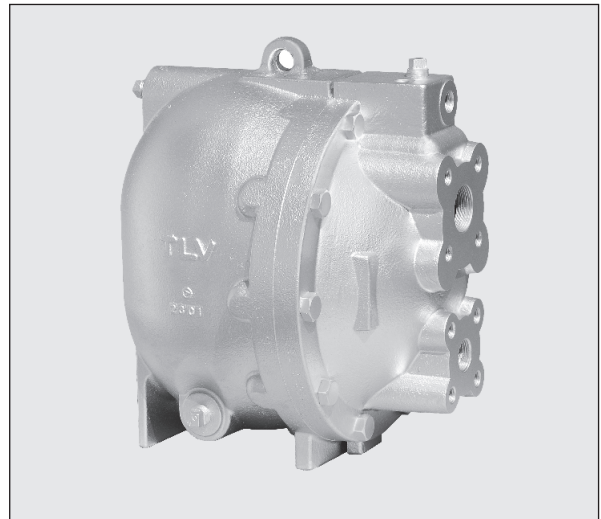

Specifications

Model	GT14L	
Connection	Pumped Medium Inlet & Outlet	Flanged*
	Motive Medium & Pump Exhaust	Screwed
Size (mm)	Pumped Medium: Inlet x Outlet	40 x 25
	Motive Medium Inlet	15
	Pump Exhaust Outlet	15
Maximum Operating Pressure (MPaG)	PMO	1.4
Maximum Operating Temperature (°C)	TMO	220
Motive Medium Pressure Range (MPaG)		0.03 to 1.4
Maximum Allowable Back Pressure		0.05 MPa less than motive medium pressure used
Volume of Each Discharge Cycle (l)		Approx. 8.0
Motive Medium**		Saturated Steam
Pumped Medium***		Steam Condensate

* For details of flange connection, see picture at bottom right. ** Do not use with toxic, flammable or otherwise hazardous fluids. 1 MPa = 10.197 kg/cm²
 *** Do not use for fluids with specific gravities under 0.85 or over 1, or for toxic, flammable or otherwise hazardous fluids.

PRESSURE SHELL DESIGN CONDITIONS (NOT OPERATING CONDITIONS):

Maximum Allowable Pressure (MPaG) PMA: 1.6 (Cast Iron), 2.1 (Cast Steel)
 Maximum Allowable Temperature (°C) TMA: 220 (Cast Iron), 260 (Cast Steel)

CAUTION To avoid abnormal operation, accidents or serious injury, DO NOT use this product outside of the specification range. Local regulations may restrict the use of this product to below the conditions quoted.

No.	Description	Material	JIS	ASTM/AISI*
①	Body	Cast Iron	FC250	A126 Cl.B
		Cast Steel**	—	A216 Gr.WCB
②	Cover	Cast Iron	FC250	A126 Cl.B
		Cast Steel**	—	A216 Gr.WCB
③	Cover Gasket	Graphite Compound	—	—
④	Float	Stainless Steel	SUS316L	AISI316L
⑤	Snap-action Unit	Stainless Steel	—	—
⑥	Motive Medium Intake Valve Unit	Inlet Valve	SUS440C	AISI440C
		Valve Seat	SUS420F	AISI420F
⑦	Exhaust Valve Unit	Exhaust Valve	SUS440C	AISI440C
		Valve Seat	SUS420F	AISI420F
⑧	Steam Trap Unit	Stainless Steel	—	—
⑨	Inlet Check Valve CKF5M	Stainless Steel	SUS304	AISI304
⑩	Outlet Check Valve CKF3M	Cast Stainless Steel	—	A351 Gr.CF8

* Equivalent ** Option: Cast Stainless Steel

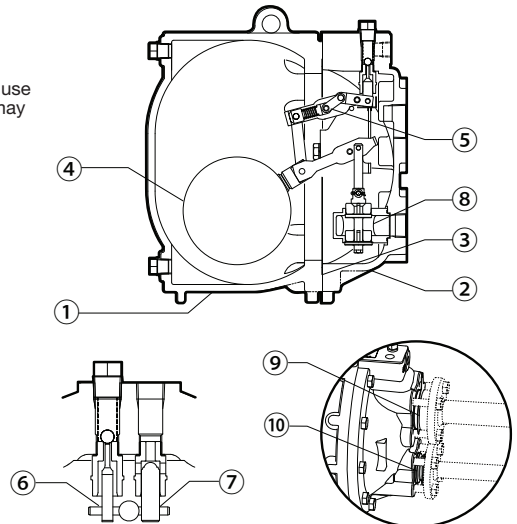

Dimensions

Units: mm

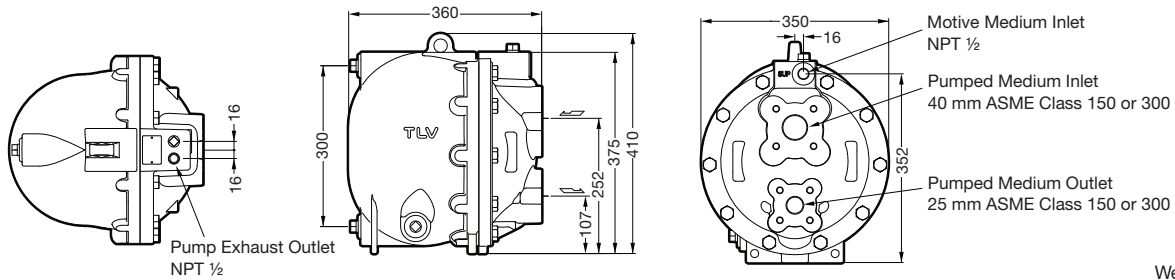

Note: All Plug Holes NPT 1/2

Weight (kg)

Cast Iron	56
Cast Steel	61

Discharge Capacity

Connection:	Flanged
Inlet size:	40 mm
Outlet size:	25 mm
Check Valve:	
Inlet (CKF5M):	40 mm
Outlet (CKF3M):	25 mm
Filling Head:	630 mm

● Correction Factor

For GT14L installed with filling head other than 630 mm (minimum filling head: 300 mm)

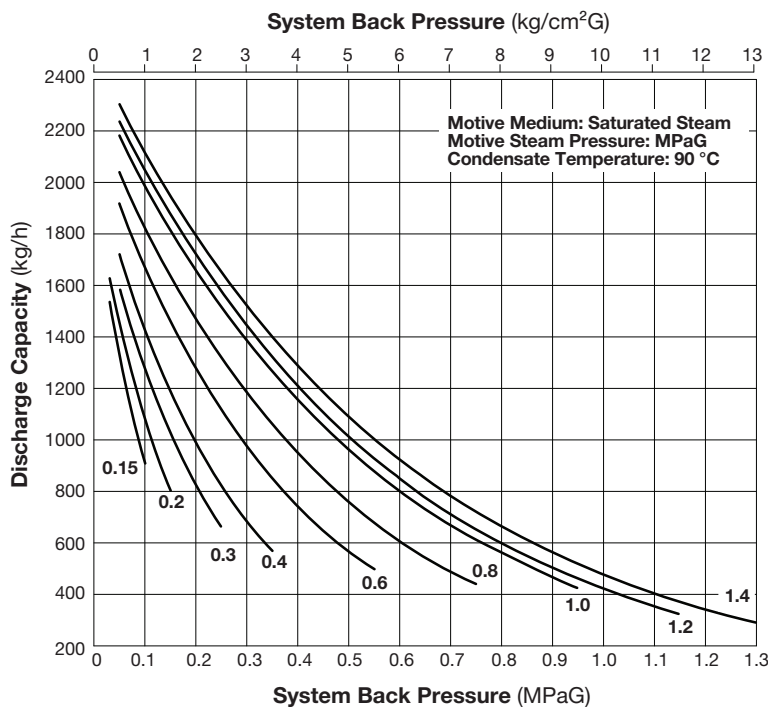
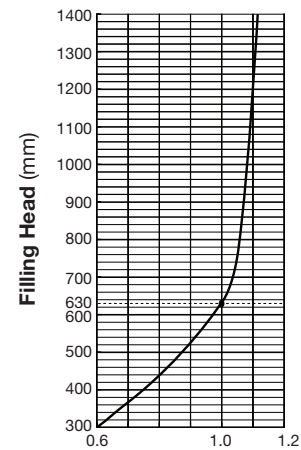

● Illustration of Filling Head and Pressures

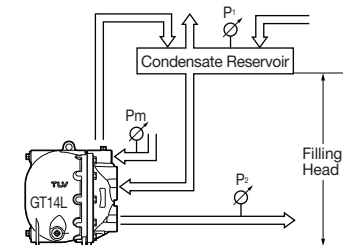

● The discharge capacity is determined by the motive medium, motive medium pressure (P_m) and back pressure (P_2).

Make sure that:
 Discharge Capacity × Correction Factor
 > Required Flow Rate

NOTE:

- A check valve must be installed at both the pumped medium inlet and outlet. To achieve the above capacities with the standard GT14L configuration, TLV check valves CKF5M for inlet and CKF3M for outlet must be used.
- Motive steam pressure minus back pressure must be greater than 0.05 MPa.
- A strainer must be installed at the motive medium and pumped medium inlets.

Size of Reservoir

The reservoir must have a capacity sufficient to store the condensate produced during the PowerTrap operation and discharge.

Size of Reservoir (flash steam is not involved)

Amount of condensate (kg/h)	Reservoir Diameter (mm) and Length (m)						
	40	50	80	100	150	200	250
300 or less	1.2 m	0.7					
400	1.5	1.0					
500	2.0	1.2	0.5				
600		1.5	0.6				
800		2.0	0.8	0.5			
1000			1.0	0.7			
1500			1.5	1.0			
2000			2.0	1.3	0.6		
3000				2.0	0.9	0.5	
4000					1.2	0.7	
5000					1.4	0.8	0.5
6000					1.7	1.0	0.6
7000					2.0	1.2	0.7
8000						1.3	0.8
9000						1.5	0.9
10000						1.7	1.0

Reservoir length can be reduced by 50% when the motive medium pressure (Pm) divided by back pressure (P2) equals 2 or greater (when $P_m \div P_2 \geq 2$).

Steam Consumption (Motive Medium)

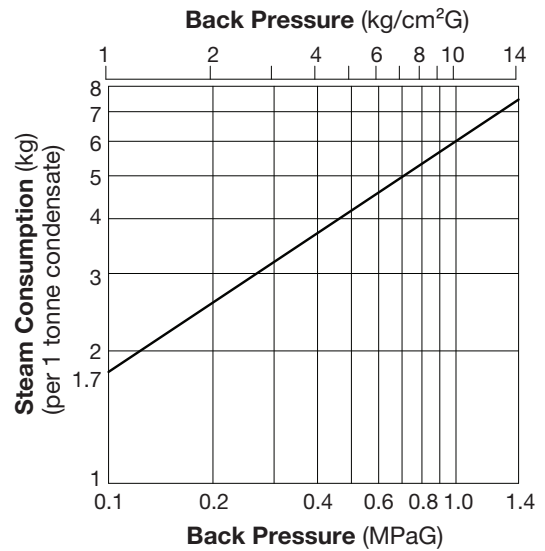

GT14L Steam Trap Discharge Capacity

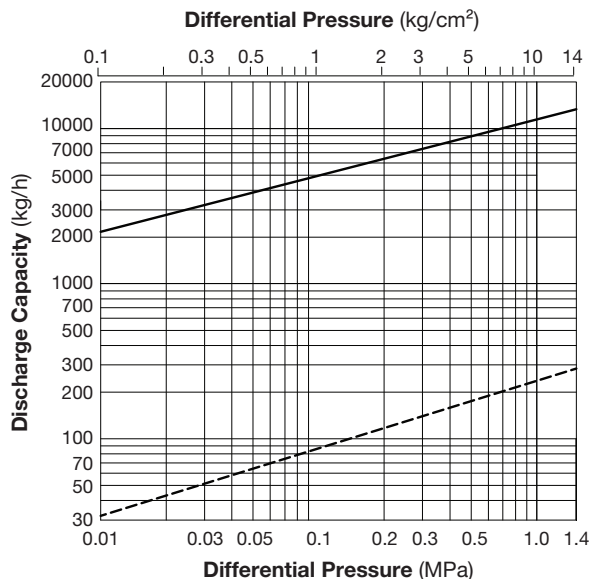

- : Capacity of GT14L as a steam trap ($P_1 > P_2$). Instantaneous condensate loads above the rated trap capacity will cause the pump to cycle and therefore reduce the discharge capacity.
- - - : Minimum amount of condensate required to prevent steam leakage.

1. Capacities are based on continuous discharge of condensate 6 °C below steam temperature.
2. Differential pressure is the difference between inlet and outlet pressure of the trap.



CAUTION DO NOT use this product under conditions that exceed maximum differential pressure, as condensate backup will occur!

Memo:

Manufacturer
TLV® **CO., LTD.**
Kakogawa, Japan
is approved by LRQA Ltd. to ISO 9001/14001

