



# TEMPERATURE CONTROL STEAM TRAP

## MODEL LEX3N-TZ

ADJUSTABLE THERMOSTATIC TRAP CONTROLS CONDENSATE DISCHARGE TEMPERATURE

### Features

**Stainless steel-bodied bimetal thermostatic steam trap for accurate control of condensate discharge temperature. For use with steam tracing lines, storage tanks, instrument enclosures, steam trap air venting, and freeze protection of condensate lines.\***

1. Maintains temperature at preset levels between 50 and 200 °C by setting the valve closing temperature.
2. Saves energy by utilizing the sensible heat in condensate.
3. Includes a built-in device for removing scale and build-up from the valve seat.
4. Overexpansion mechanism prevents damage to the bimetal element and ensures long service life.
5. Rapid venting of initial air and fast discharge of cold condensate reduce start-up time.
6. Inline access to internal parts simplifies cleaning and reduces maintenance costs.
7. Built-in screen ensures trouble-free operation.
8. Can be used as an automatic non-freeze valve.

\* See 'Applications' on page 2.

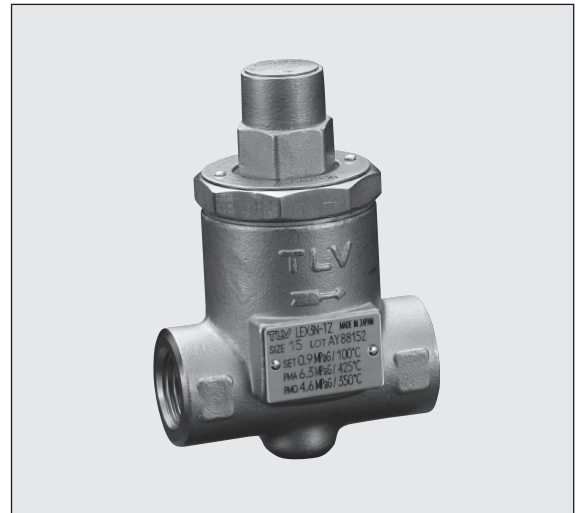

**CAUTION** DO NOT REMOVE CAP NUT OR COVER WHILE TRAP IS UNDER PRESSURE. Allow trap body temperature to cool to room temperature before removing cap nut or cover. Failure to do so may result in burns or other injury. READ INSTRUCTION MANUAL CAREFULLY.

### Specifications

Model	LEX3N-TZ		
Connection	Screwed	Socket Welded	Flanged
Size (mm)	10, 15, 20, 25		15, 20, 25
Maximum Operating Pressure (MPaG) PMO	4.6		
Minimum Operating Pressure (MPaG)	0.1		
Maximum Operating Temperature (°C) TMO	350		
Condensate Temperature Setting Range (°C)	50 - 200* (see graph right)		

\* Set temperature should be more than 15 °C below the steam saturation temperature. 1 MPa = 10.197 kg/cm<sup>2</sup>

**PRESSURE SHELL DESIGN CONDITIONS (NOT OPERATING CONDITIONS):**  
 Maximum Allowable Pressure (MPaG) PMA: 6.3 Maximum Allowable Temperature (°C) TMA: 425  
 The trap may be installed either horizontally or vertically. However, when installing horizontally, make sure that the trap is installed with the temperature adjusting screw positioned higher than the piping in which the trap is installed. (Upside-down installation is not permissible.)



To avoid abnormal operation, accidents or serious injury, DO NOT use this product outside of the specification range. Local regulations may restrict the use of this product to below the conditions quoted.

No.	Description	Material	JIS	ASTM/AISI*
①	Body	Cast Stainless Steel	—	A351 Gr.CF8
②	Cover	Stainless Steel	SUS303	AISI303
③ <sup>R</sup>	Valve Stem	Stainless Steel	SUS420J2	AISI420
④	Adjusting Screw	Stainless Steel	SUS303	AISI303
⑤ <sup>R</sup>	Bimetal Element	Bimetal	—	—
⑥ <sup>R</sup>	Washer	Stainless Steel	SUS304	AISI304
⑦ <sup>R</sup>	Valve Seat	Stainless Steel	SUS303	AISI303
⑧ <sup>MR</sup>	Valve Seat Gasket	Stainless Steel	SUS316L	AISI316L
⑨ <sup>R</sup>	Overexpansion Spring	Stainless Steel	SUS304	AISI304
⑩ <sup>R</sup>	Return Spring	Stainless Steel	SUS304	AISI304
⑪ <sup>R</sup>	Snap Ring	Stainless Steel	SUS304	AISI304
⑫ <sup>R</sup>	Spring Pin	Stainless Steel	SUS304	AISI304
⑬ <sup>MR</sup>	Seal Ring	Fluorine Rubber	FPM	D2000HK
⑭ <sup>R</sup>	Screen inside/outside	Stainless Steel	SUS430/304	AISI430/304
⑮	Lock Nut	Stainless Steel	SUS303	AISI303
⑯	Cap Nut	Cast Stainless Steel	—	A351 Gr.CF8
⑰ <sup>MR</sup>	Cover Gasket	Stainless Steel	SUS316L	AISI316L
⑱	Nameplate	Stainless Steel	SUS304	AISI304
⑲ <sup>R</sup>	Spring Guide	Stainless Steel	SUS304	AISI304
⑳ <sup>R</sup>	Thrust Plate	Stainless Steel	SUS304	AISI304
㉑ <sup>MR</sup>	Cap Nut Gasket	Graphite	—	—
㉒	Flange**	Cast Stainless Steel	—	A351 Gr.CF8

### ● Temperature Setting Range

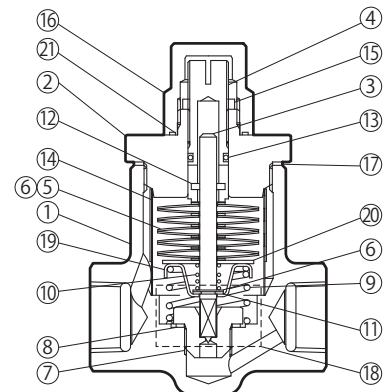
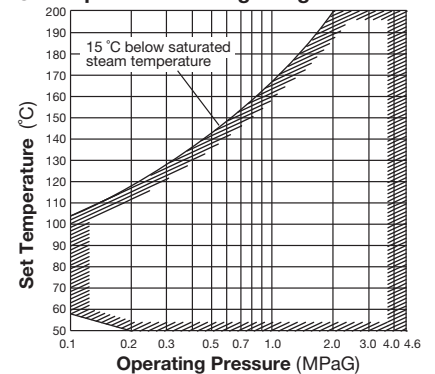

\* Equivalent \*\* Shown on reverse  
 Replacement kits available:  
 (M) maintenance parts,  
 (R) repair parts

**Dimensions**

● **LEX3N-TZ**  
Screwed

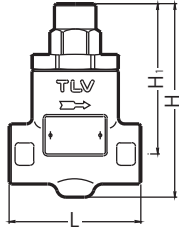

● **LEX3N-TZ**  
Socket Welded

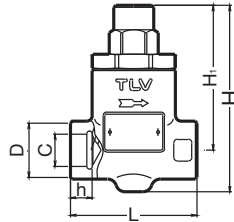

● **LEX3N-TZ**  
Flanged

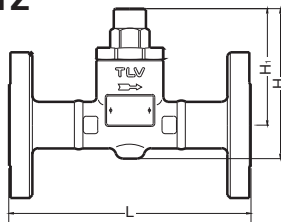

**LEX3N-TZ** Screwed\* Socket Welded (mm)

Size	L	H	H <sub>1</sub>	φD	φC	h	Weight (kg)
10	70	103	80	30	17.8	12	0.8
15					22.2		
20	80	113	90	44	27.7	14	1.3
25					34.5		1.2

\* Rc(PT), other standards available

**LEX3N-TZ** Flanged (mm)

Size	L		H	H <sub>1</sub>	Weight* (kg)
	ASME Class				
	150RF	300RF			
15	146	146	103	80	2.3
20	166	166	113		3.3
25	186	186			4.0

Other standards available, but length and weight may vary

\* Weight is for Class 300 RF

**Sizing Charts**

**Estimation of Discharge Capacity.**

Example: The flow rate of condensate discharging from 0.9 MPaG to atmosphere at 110 °C from a trap set to 120 °C is determined as follows:

**Step 1: Use the discharge capacity graph.**

From the 110 °C condensate temperature on the horizontal axis, follow a vertical line until it intersects the 120 °C set temperature curve (point A). From A, follow a horizontal line across to the vertical axis (point B), and read the discharge capacity, 120 kg/h.

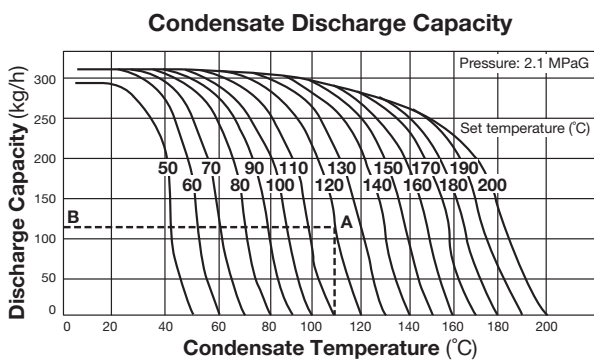

Recommended safety factor: at least 2.

**Step 2: Use the correction graph.**

Because the discharge capacity graph is based on a steam pressure of 2.1 MPaG, a correction factor must be used to adjust the discharge capacity value to the actual pressure differential at the trap. Read up from 0.9 MPa on the horizontal axis to the diagonal line (point C), then across to the correction factor (point D), 0.64. Multiply the discharge capacity obtained in step 1 by the correction factor to get the actual discharge capacity: 120 kg/h x 0.64 = 76.8 kg/h

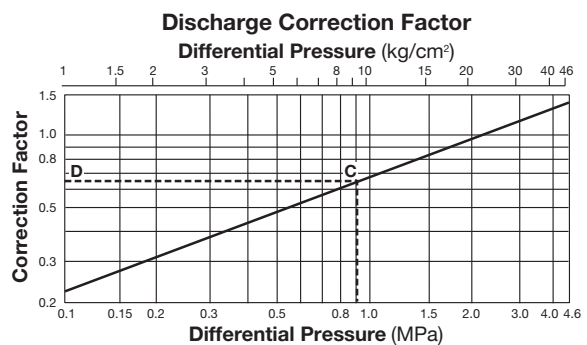

Differential pressure is the difference between the inlet and outlet pressure of the trap.

**Applications**

**DO NOT USE** on any application **except** steam tracing lines, storage tank coils, instrument enclosures, steam trap venting, and freeze protection of condensate lines.

**SUITABLE** for steam tracing lines or storage tank coils **ONLY IF** the required product viscosity will be maintained when the condensate is subcooled at least 15 °C, even to the point of the condensate having a lower temperature than the product temperature.

**SUITABLE** for use on instrument enclosures **ONLY IF** the steam or condensate temperature in the enclosures will **NOT** damage the instrument.

**SUITABLE** for use as an external air vent for TLV steam traps, or as a non-freeze valve for freeze protection of condensate lines.

Manufacturer

**TLV** CO., LTD.  
Kakogawa, Japan

is approved by LRQA Ltd. to ISO 9001/14001

ISO 9001  
ISO 14001

